

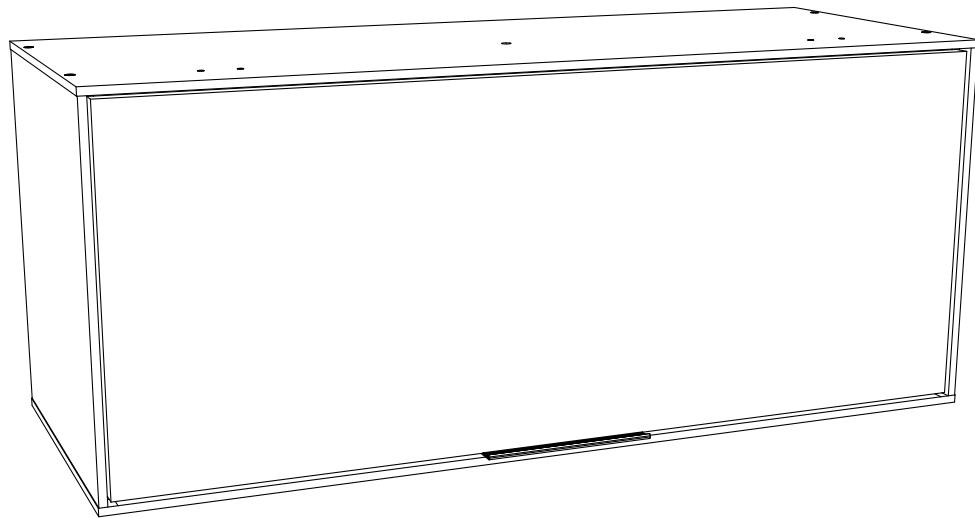

**PRODUTO CONCLUÍDO
PRODUCTO TERMINADO
FINISHED PRODUCT**



HENN

Ind. e Com. de Móveis Henn
Mondaí - SC - Brasil

+55 49 3674.3500

@moveishenn
www.henn.com.br

**INSTRUÇÕES DE
MONTAGEM**

INSTRUCCIONES DE MONTAJE
ASSEMBLY INSTRUCTIONS

**AÉREO 01 PORTA BASCULANTE 800MM FINEZE | PUERTA AIR 01 INCLINABLE
800MM FINEZE | AIR 01 DOOR TILTING 800MM FINEZE**

C657-133 Areia HP

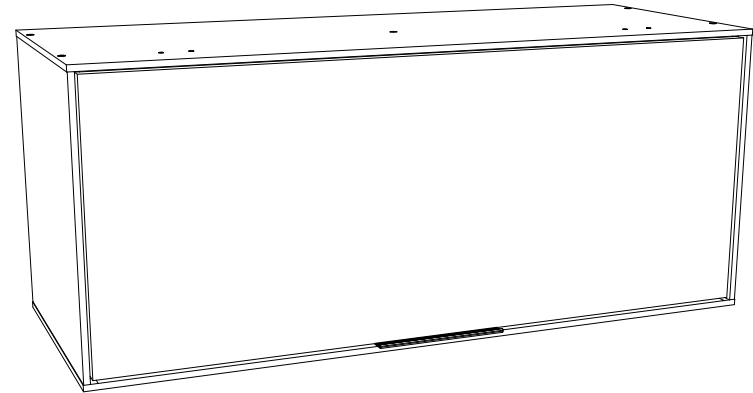

AVISO

Para limpeza de seu móvel, use uma flanela seca ou umedecida, e não utilize produtos químicos que possam danificar seu produto.

SISTEMA DE MONTAGEM

O sistema de montagem dos produtos, funciona de acordo com a ordem crescente dos números indicados no desenho. Ex: 01, 02, 03, 04... até a conclusão da montagem.

ASSISTÊNCIA TÉCNICA

Para solicitação de Assistência Técnica você consumidor deverá entrar em contato com o Lojista o qual você realizou a compra deste produto e solicitar a assistência técnica das peças avariadas. A garantia abrange todas as peças, partes e componentes que eventualmente venham apresentar defeito de fabricação no prazo de 03 (três) meses, contando a partir da entrega do produto ao consumidor, mediante nota fiscal de compra. Se houver qualquer alteração na estrutura do produto ou ocorrer defeito por negligência do montador/consumidor em relação a instrução de montagem e manuseio, não será fornecido assistência técnica gratuita.

ADVERTENCIA

Para limpieza de su móvil, use una franela seca o húmeda, y no utilice productos químicos que puedan dañar su producto.

SISTEMA DE MONTAJE

El sistema de montaje de los productos funciona de acuerdo con el orden creciente de los números indicados en el dibujo. Ej.: 01, 02, 03, 04... hasta la conclusión del montaje.

ASISTENCIA TÉCNICA

Para solicitar Asistencia Técnica, el consumidor debe comunicarse con el Comercio que usted realizó la compra de este producto y solicita asistencia técnica para las partes dañadas. La garantía cubre todas las partes, piezas y componentes que eventualmente puedan presentar defecto de fabricación en el plazo de 03 (tres) meses, contados a partir de la entrega del producto al consumidor, mediante factura de compra. Si se produce algún cambio en la estructura del producto o se produce un defecto por negligencia del montador/consumidor en relación con las instrucciones de montaje y manipulación, no se prestará asistencia técnica gratuita.

NOTICE

To clean your furniture, use a dry or wet cloth, and do not use chemicals that may damage your product.

ASSEMBLY SYSTEM











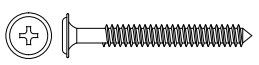

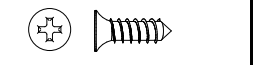
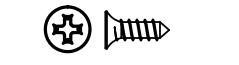
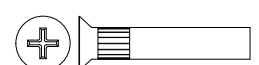
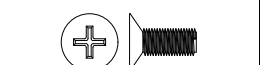

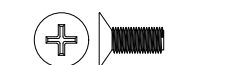
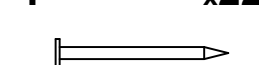
The products' assembly system works according to the increasing order of the indicated numbers. For example: 01, 02, 03, 04 ... to the end of the assembly.

TECHNICAL ASSISTANCE

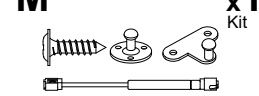
To request Technical Assistance, the consumer must contact the retailer from whom you purchased this product and request technical assistance for the damaged parts. The warranty covers all parts, parts and components that may eventually present a manufacturing defect within a period of 03 (three) months, counting from the delivery of the product to the consumer, by means of a purchase invoice. If there is any change in the structure of the product or defect occurs due to negligence of the assembler/consumer in relation to the assembly and handling instruction, free technical assistance will not be provided.

ACESSÓRIOS | ACCESORIOS | ACCESSORIES

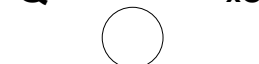

ITM/C657-

A x2  Parafuso 5,0x50mm FLA.	B x8  Parafuso 3,5x40mm CHT.	C x12  Parafuso 4,0x14mm CHT.	D x2  Parafuso 3,5x12mm CHT.
E x4  Parafuso União Fêmea 27mm CHT	F x4  Parafuso União Macho 12mm CHT	G x4  Parafuso União Fêmea 15mm CHT	H x4  Parafuso União Macho 11mm CHT
I x22  Prego 10x10mm	J x2  Bucha Plástica 8mm	K x2  Suporte de Fixação	L x2  Proteção Cantoneira
M x1  Kit Pistão a Gás 60N	N x1  Perfil Puxador RX014 150mm	O x1  Kit c/ 02 Dobradiças 35mm Pop Alta +Calço Fixo	P x1  Etiqueta Resinada Henn
Q x8  Adesivo Tapa Parafuso 10mm	R x2  Giz de Correção		

MONTAGEM 6 | MONTAJE 6 | ASSEMBLY 6

ITM/C657-

ACESSÓRIOS REQUERIDOS

P		01
Q		02
R		08

Pesos máximos recomendados com carga distribuída.
Peso máximo recomendado con la carga distribuida.
Recommended maximum weight with distributed load.

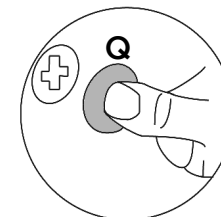
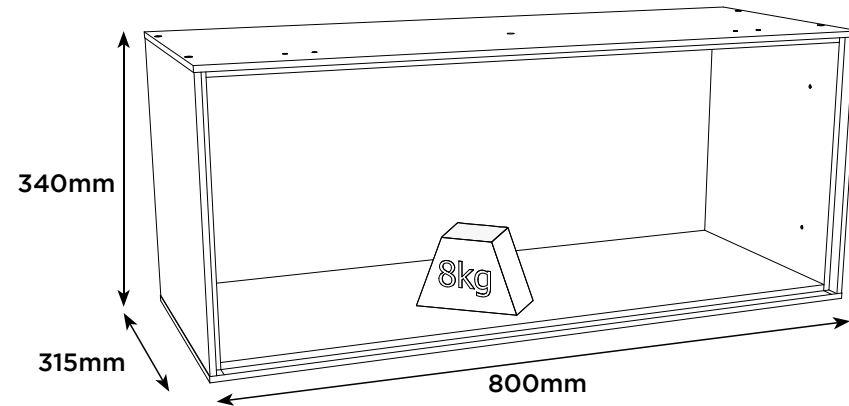

PERFECT CORRECTION
CORRECCIÓN PERFECTA

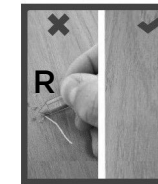

ACESSÓRIOS REQUERIDOS

A		02	J		02
C		04	K		02
			L		02

FERRAMENTAS NECESSÁRIAS

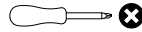

Fixar móvel na Parede

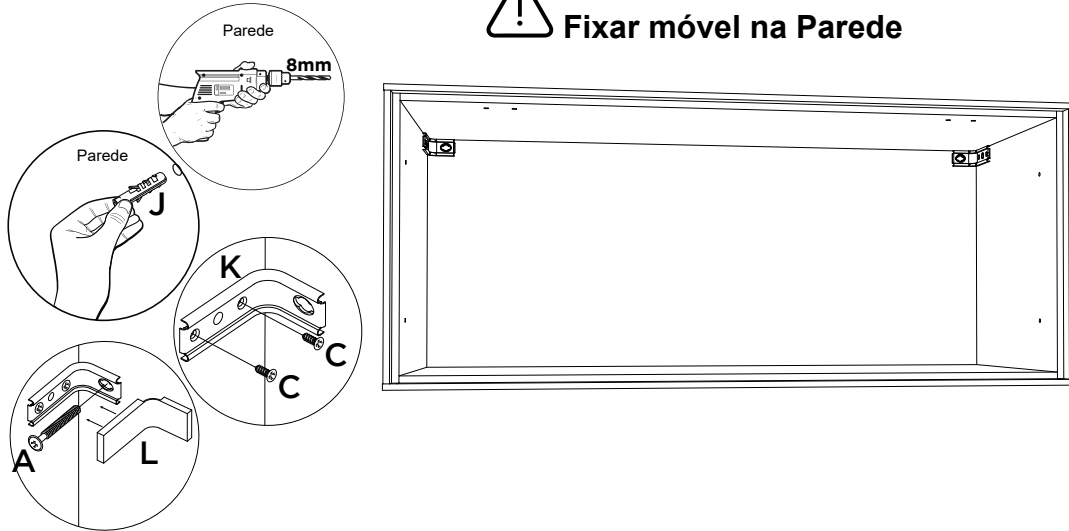

MONTAGEM 5 | MONTAJE 5 | ASSEMBLY 5

ACESSÓRIOS REQUERIDOS

E		04	F		04
---	--	----	---	--	----

FERRAMENTAS NECESSÁRIAS

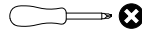

OBSERVAÇÃO:

Os parafusos (E e F) devem ser usados somente quando esse módulo for acoplado em outro módulo componível.

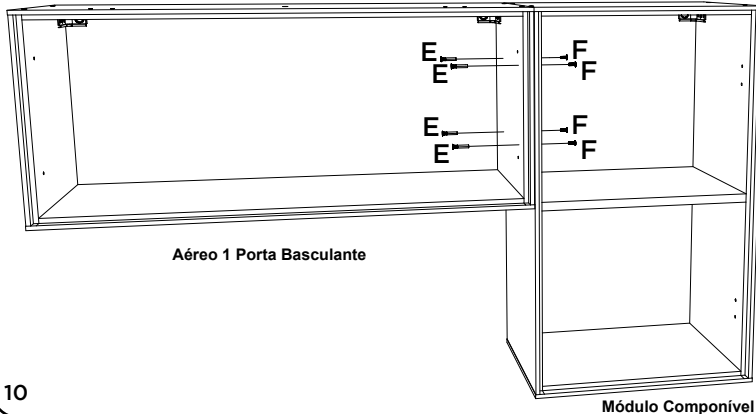

Fazer furação passante assim que os módulos estiverem alinhados.

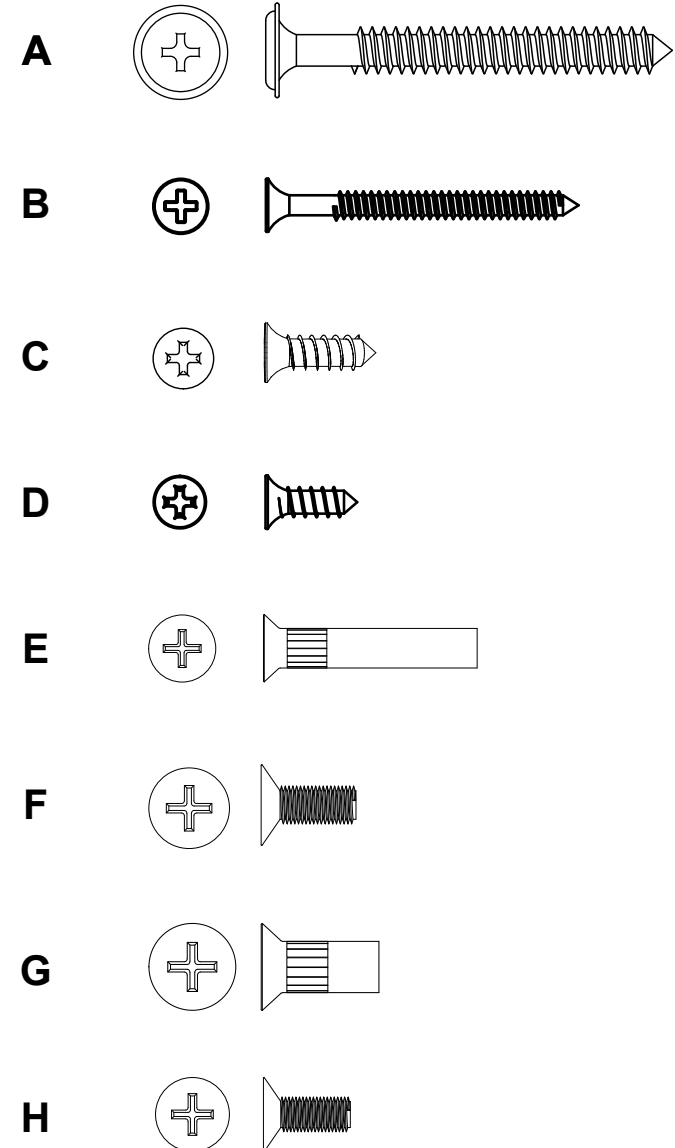

LISTA DE PEÇAS | LISTA DE PIEZAS | LIST OF PIECES





Item	Caixa Caja Box	Qty Ctd Qty	Descrição Descripción Description	Dimensões (mm) Dimensiones (mm) Dimensions (mm)		
				Comprimento Largo Length	Largura Ancho Width	Espessura Grosor Thickness
1	1/1	1	BASE BASE BASE	800	312	15
2	1/1	2	LATERAL DIREITA ESQUERDA LATERAL DERECHA IZQUIERDA RIGHT LEFT SIDE	323	312	15
3	1/1	1	TAMPO TAPA TOP	800	312	15
4	1/1	1	FUNDO FONDO BOTTOM	793	331	3
5	1/1	1	PORTA PUERTA DOOR	779	317	15

MONTAGEM 3 | MONTAJE 3 | ASSEMBLY 3

PEÇAS REQUERIDAS

5	PORTA	x1
---	-------	----

ACESSÓRIOS REQUERIDOS

C		04
G		04
H		04
M		01

FERRAMENTAS NECESSÁRIAS

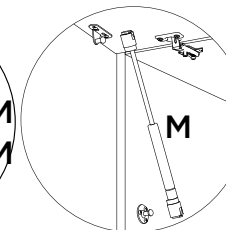
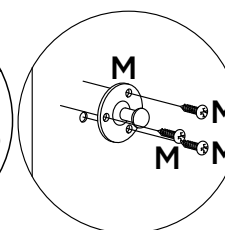
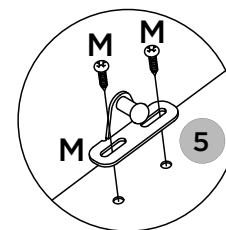
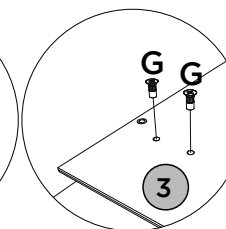
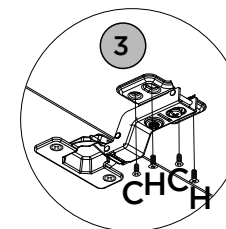
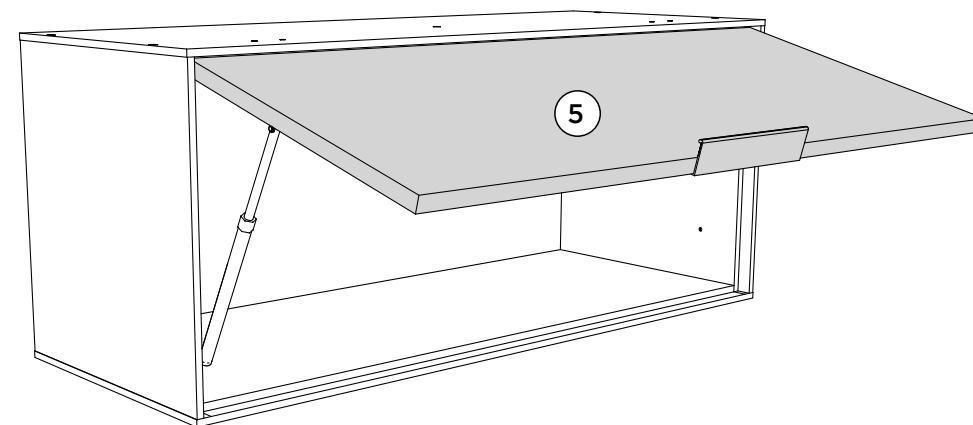

PEÇAS REQUERIDAS

4	FUNDO	x1
---	-------	----

ACESSÓRIOS REQUERIDOS

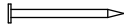
1		22
---	---	----

FERRAMENTAS NECESSÁRIAS

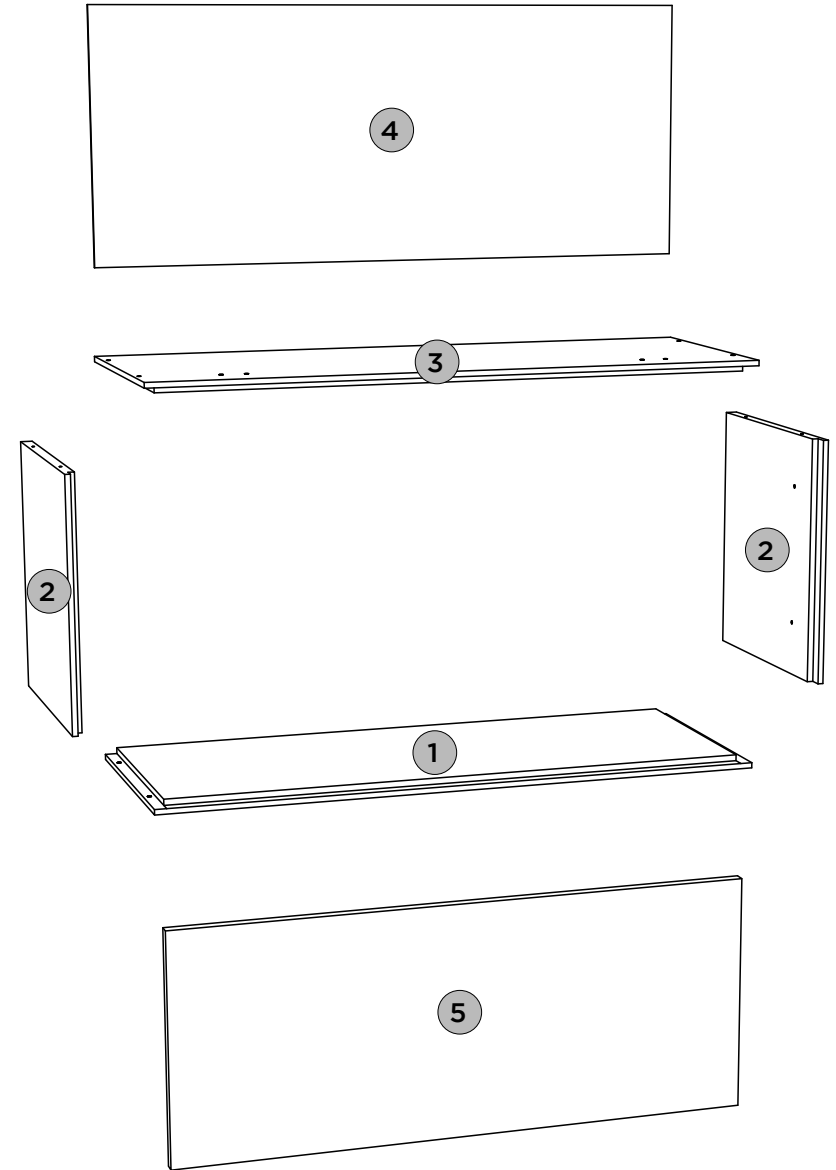
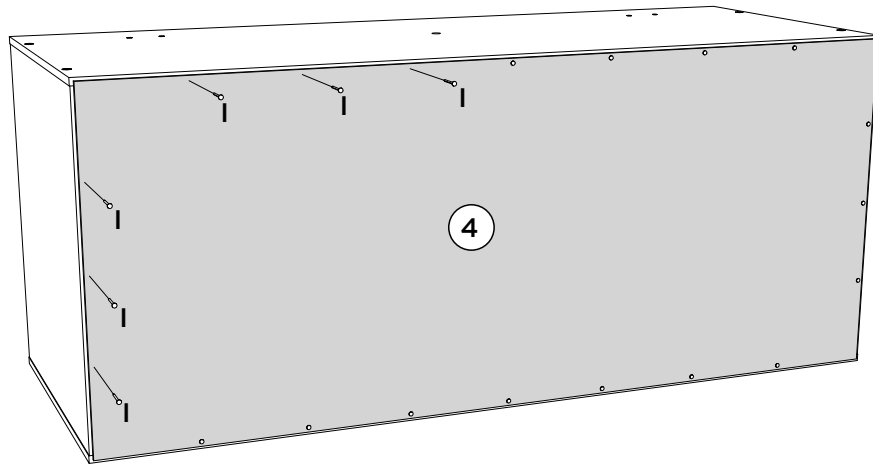

REQUISITOS PARA MONTAGEM
REQUISITOS PARA LA MONTAJE | ASSEMBLY REQUIREMENTS.

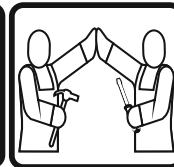
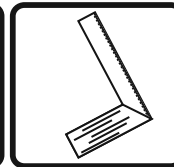
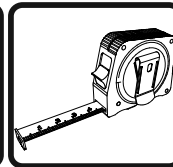
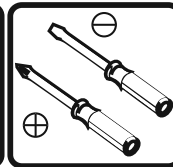
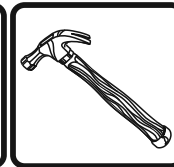
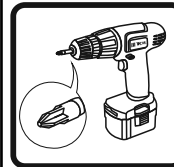





Imagens meramente ilustrativas, não acompanha o produto.
Imágenes ilustrativas, no incluidas con el producto.
Illustrative images, not included with the product.

PEÇAS REQUERIDAS

ACESSÓRIOS REQUERIDOS

FERRAMENTAS NECESSÁRIAS

5	PORTA	x1
---	-------	----

C		04
D		02
N		01
O		02

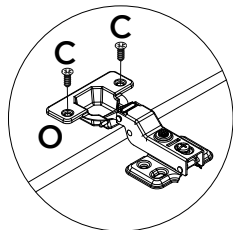
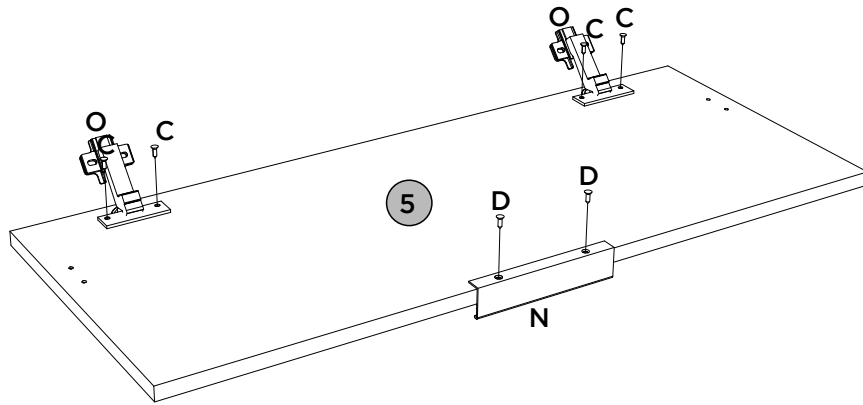
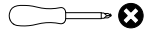

PEÇAS REQUERIDAS

ACESSÓRIOS REQUERIDOS

FERRAMENTAS NECESSÁRIAS

1	BASE	x1
2	LATERAL DIREITA ESQUERDA	x2
3	TAMPO	x1

B		08
---	---	----

