

# Manual de Montagem

## Sofá Cama Puff

CERTIFICADO  
**90**  
dias  
GARANTIA

### Observações:

- 1 O manuseio e montagem do produto deverão ser feitos por profissionais especializados;
- 2 A limpeza deverá ser feita com pano úmido (água), sem uso de produtos químicos.

Desenvolvido por Wesley Silva







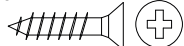

Dúvidas e sugestões:

(31) 99280-0176 ou (31) 3184-0050

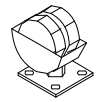
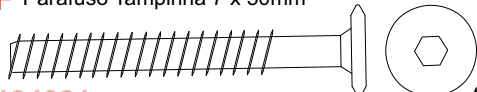
CONQUISTA  
MÓVEIS

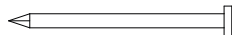
Cód.	989	Volumes		Kit de Montagem
		Gaveta	Barras	
Ref.	501016	408004	403022	141024

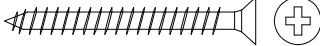
Códigos			Cores	Características			Qtd.
Peças	Sistema	Referência		BR			
1	994	312029	03	Lateral Dir Esq Cama Puff	MDF/MDP	840 x 290 x 15	02
2	998	314020	03	Suporte Sustentação Corrediça Puff	MDF/MDP	815 x 165 x 18	01
3	995	303020	03	Barra Frente Cama Puff	MDF/MDP	1860 x 100 x 15	01
4	996	303021	03	Barra Traseira Cama Puff	MDF/MDP	1860 x 265 x 15	01
5	997	314019	03	Suporte Inferior Cama Puff	MDF/MDP	1860 x 100 x 15	02
6	5118	136035	12	Travessa Madeira Cama Puff	Madeira	800 x 43 x 22	04
7	4165	136044	12	Ripa de Madeira	Madeira	1850 x 45 x 8	06
8	999	308020	03	Frente Gaveta Cama Puff	MDF	912 x 155 x 15	02
9	159	308002	03	Lateral Gaveta Bibox	MDP/MDF	486 x 105 x 15	04
10	1000	308021	03	Traseiro Gaveta Cama Puff	MDP/MDF	866 x 80 x 15	02
11	1001	309021	03	Fundo Gaveta Cama Puff	HDF	876 x 492 x 2,5	02

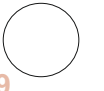
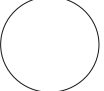
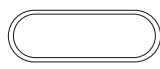
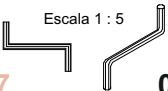
<b>A</b> Par Corrediças 400 mm  <b>134005</b> <b>02</b>	<b>B</b> Parafuso Chipboard 3,5 x 14mm  <b>134131</b> <b>62</b>	<b>C</b> Parafuso Corrediça 6 x 10  <b>134023</b> <b>04</b>	<b>D</b> Parafuso Escareado 7 x 40mm  <b>134033</b> <b>22</b>
<b>E</b> Rodízios RB 30 Giratório  <b>134114</b> <b>06</b>	<b>F</b> Parafuso Tampinha 7 x 50mm  <b>134021</b> <b>08</b>	<b>G</b> Cantoneira ' L ' 17 x 17  <b>134010</b> <b>01</b>	<b>H</b> Pregos P/ Estrado 12 x 12  <b>134004</b> <b>30</b>
<b>I</b> Cavilha 6 x 30mm  <b>134028</b> <b>08</b>	<b>J</b> Cantoneira 4 Furos ' L ' 17 x 30  <b>134068</b> <b>04</b>	<b>K</b> Paraf. Chipboard 3,5 x 35mm  <b>134009</b> <b>08</b>	<b>L</b> Pregos P/ Gaveta 8 x 8  <b>134012</b> <b>16</b>
<b>M</b> Bisnaga Cola 5g  <b>134014</b> <b>01</b>	<b>N</b> Tampa Parafuso Ø10  <b>134069</b> <b>22</b>	<b>O</b> Tampa Parafuso Ø13  <b>134007</b> <b>08</b>	<b>P</b> Puxador oval 100 x 30  <b>134109</b> <b>02</b>
			<b>Q</b> Chave " Z " 48 x 19  <b>134047</b> <b>01</b>

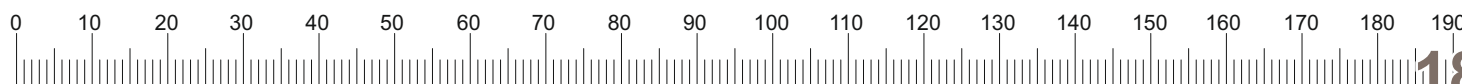

PASSO A PASSO DA MONTAGEM

1° Forrar o chão com o papelão da embalagem para montagem do sofá.

- a) Fixar as corredeiras **A** nas laterais **1** c/ paraf. **B**, 3,5 x 16mm.  
Fixar a corredeira no 2° furo do alinhamento com a rodinha.

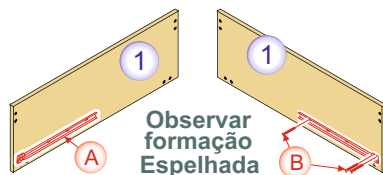

- b) Fixar as corredeiras **A** no suporte **2** c/ paraf. **C** e reforço **B**.

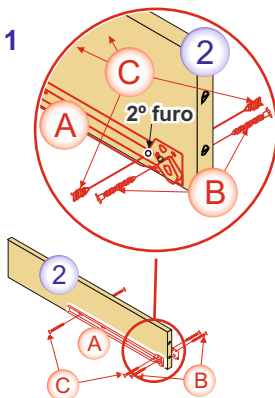

2° Parafusar as laterais **1** nas barras **3** e **4** c/ paraf. **D**, 7 x 40mm

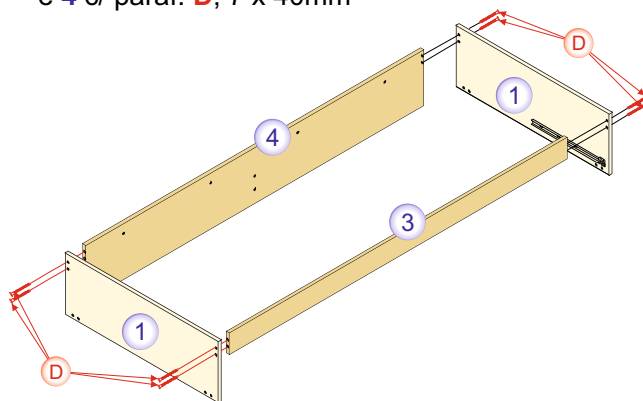

- a) Virar a estrutura para fixação dos suportes.

- b) Parafusar os suportes inferiores **5** nas laterais **1** c/ paraf. **D**.

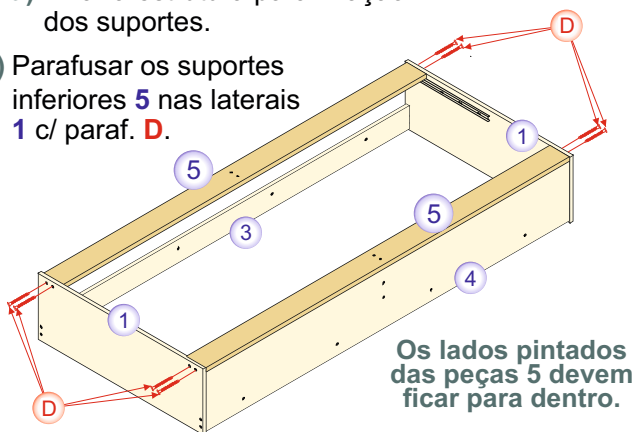

4° a) Parafusar o suporte sustentação **2** na barra **4** e suporte inferior **5** c/ paraf. **D**.

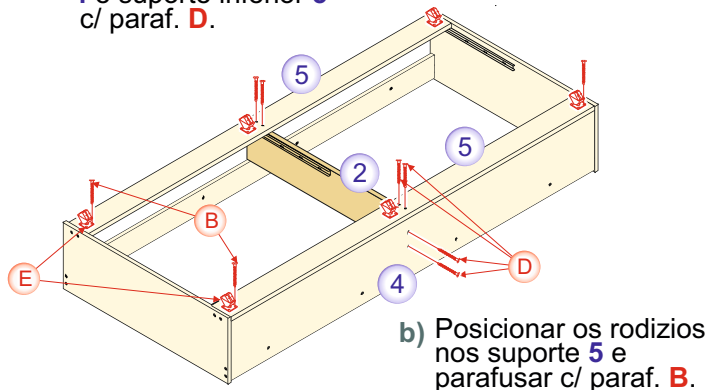

5° a) Parafusar as travessas **6** nas barras **3** e **4** c/ paraf. **F**, 7 x 50mm.

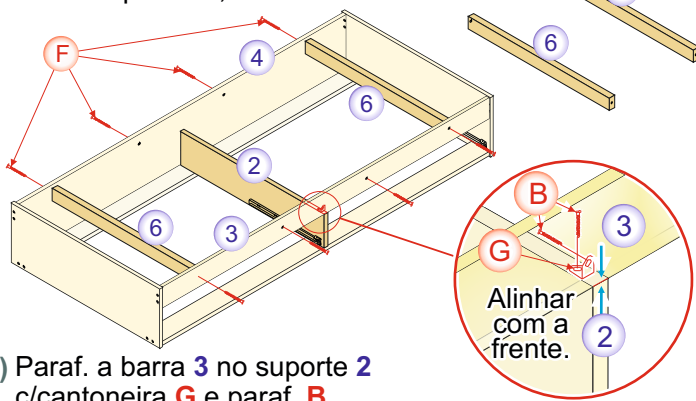

- b) Paraf. a barra **3** no suporte **2** c/cantoneira **G** e paraf. **B**.

6° Pregar as ripas **7** nas travessas **6** c/ pregos **H**, num espaçamento adequado.

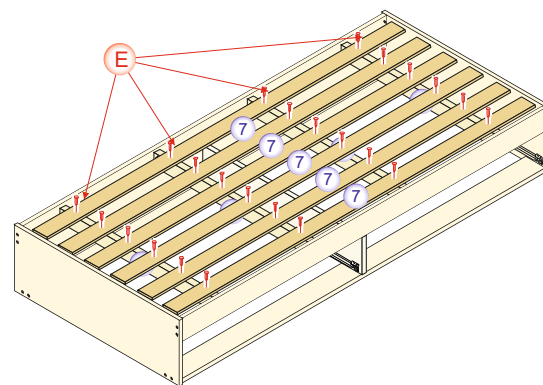

7° Gavetas

- a) Montar as laterais **9** nas frentes **8** c/ cavilhas **I** e cantoneiras **J** c/ de cola **M** e paraf. **B**.

- b) Fixar corredeira **A** nas laterais **9** c/ paraf. **B**.

- c) Parafusar o traseiro **10** c/ paraf. **K**.

- d) Encaixar e pregar os fundos **11** c/ prego **L**.

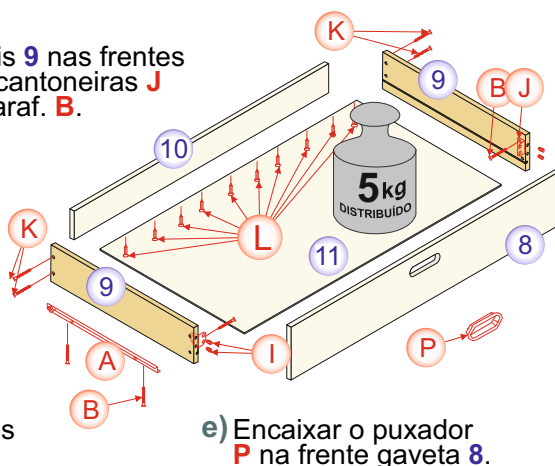

- e) Encaixar o puxador **P** na frente gaveta **8**.

8° Produto montado, Encaixar os tampa parafuso **N** e **O**.

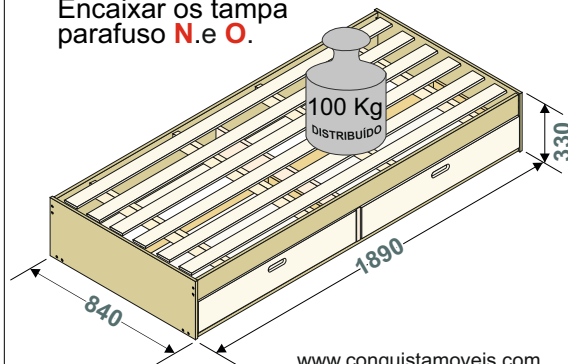

www.conquistamoveis.com  
R: João Paulino, 800 - Itaguara - MG  
Cep: 35488-000 Tel.: (31) 3184 - 0050  
sac@conquistamoveis.com.br

Observações:

- a) Peso máximo suportado pelas gavetas 5 Kg.  
b) Colchão recomendado: 1,88 x 0,78 x 0,14cm em Espuma

- c) As Corredeira devem ser fixadas na base da gaveta.  
d) Devem ser utilizado pelo menos 8 pregos para pregar os fundos de gaveta, numa distancia de mais ou menos 10cm.