

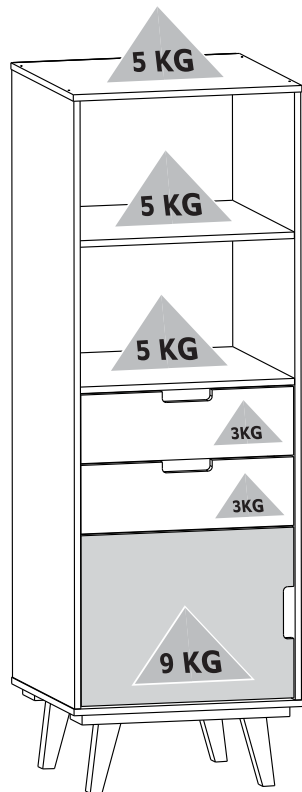

# ESTANTE VINTAGE PARIS

DIMENSÕES DO PRODUTO / DIMENSIONS PRODUCT L/WxP/DxA/H - 550x423x1618 MM



**ATENÇÃO**  
ESTE PRODUTO NÃO PODE  
SER ARRASTADO

OBS: TODAS AS PEÇAS SÃO NUMERADAS.

EX: 1915X-X 10 (nº da peça)

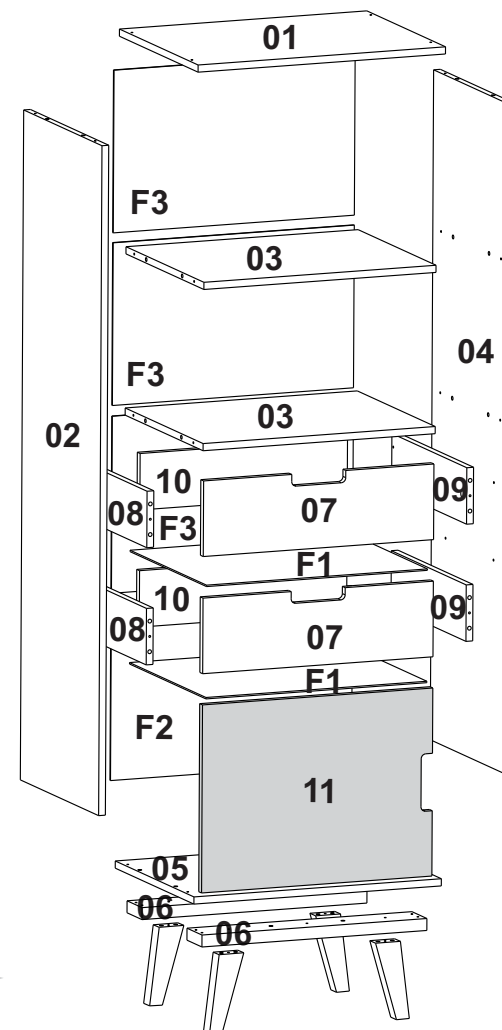

Pessoas Necessárias  
para Montagem



1 pessoa

Ferramentas Necessárias  
(Não Fornecidas)

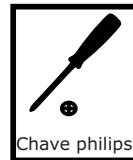

Chave philips



Martelo de  
borracha

**CUIDADOS ESPECIAIS**  
LIMPEZA- Pano limpo umedecido em água e sabão neutro.  
BRILHO- Flanela seca.

**SPECIAL CARE**  
CLEANING-Dampened cloth with water and mild soap.  
POLISH- Dry flanned.

**ATENÇÃO**  
Nunca utilizar óleos, como lustra móvel; produtos  
abrasivos, como saponáceos, esponja de aço e outros.  
**ATTENTION**  
Never use oils or abrasive products.

SETUP THE PRODUCT ON TOP OF THE PACKAGING, AVOIDING  
DAMAGE TO THE PAINT.

MONTAR O PRODUTO SOBRE A EMBALAGEM,  
EVITANDO DANOS NA PINTURA.



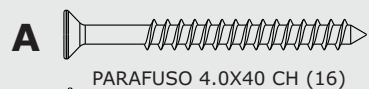

PARAFUSO 4.0X40 CH (16)



PF 3,5x35 FL (10)



PARAFUSO 3.5x14CRR (32)



CAVILHA 8X30 MM (36)

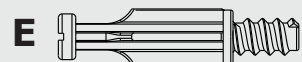

PINO MINIFIX 32 MM (12)



TAMBOR MINIFIX 15 MM (12)

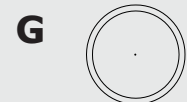

TAMPA MINIFIX (12)

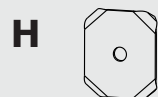

GARRA FUNDO (08)

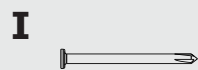

PREGO 8X8 MM (70)



CORREDIXA METÁLICA 350 MM(02 jogos)

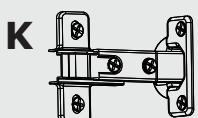

DOBRADIÇA CANECO 35 MM CALÇO 08 (02)



PÉ MADEIRA 170 MM (04)

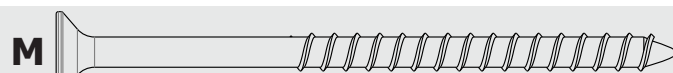

PARAFUSO 6,0X80 CH CHIP BIC (04)



SUPORTE PL 6X8MM(01)



PERFIL H PL 515 MM

ITEM		DESCRIÇÃO DAS PEÇAS				CORES			
COD	Nº	NOME	MEDIDAS	TIPO	QUANT	BCO	OFF W	RUSTIK	NATU
11355	01	TAMPO	550X420X15	MDP	01	1/05		1/24	
11351	02	LATERAL ESQUERDA	1400X418X15	MDP	01	2/05		2/24	
11353	03	PRATELEIRA SUP/INF	516X416X15	MDP	02	3/05		3/24	
11352	04	LATERAL DIREITA	1400X418X15	MDP	01	4/05		4/24	
11350	05	BASE	550X420X15	MDP	01	5/05		5/24	
12002	06	REFORÇO PÉ	500X80X25	MDF	02	6/05		6/24	
11359	07	FRENTE GAVETA	512X158X15	MDF	02	7/05		7/24	
11356	08	LATERAL GAVETA ESQUERDA	350X118X15	MDP	02	8/05		8/24	
11357	09	LATERAL GAVETA DIREITA	350X118X15	MDP	02	9/05		9/24	
11358	10	CONTRA FRENTE	461X118X15	MDP	02	10/05		10/24	
11360	11	PORTA	512X393X15	MDF	01	11/05	11/06		11/32
11361	F1	FUNDO GAVETA	491X358X3	TRI	02	F1/05		F1/24	
11362	F2	FUNDO INFERIOR	536X370X03	TRI	02	F2/05		F2/24	
11363	F3	FUNDO SUPERIOR	536X340X03	TRI	02	F3/05		F3/24	
438	A	Parafuso 4,0X40 CH			16				
12774	B	Parafuso 3,5xX35 FL			10				
986	C	Parafuso 3,5X14 CRR			32				
137	D	Cavilha 8X30 MM			36				
532	E	Pino Minifix 7,0X25			12				
508	F	Castanha Minifix 15 MM			12				
509	G	Tampa Minifix 15 MM			12	BCO		CAFÉ	
911	H	Garra Aço 13X13 MM			08				
248	I	Prego 8X8 MM			70				
12175	J	Corredixa 350 mm BIG FER(02 jogos)			02				
10556	K	Dobradiça Caneco 35MM Calço 08			02				
12076	L	Pé Madeira vintage 170 mm			04	MOGNO			
12077									CAST
11710	M	Parafuso 6,0X80 CH CHIP BIC			04				
7266	N	Suporte Pl stop			01				
12773	O	Perfil H PL 515 mm			01				
		Certificado Garantia			01				

**FIXAÇÃO: PINO E TAMBOR DE MINIFIX**

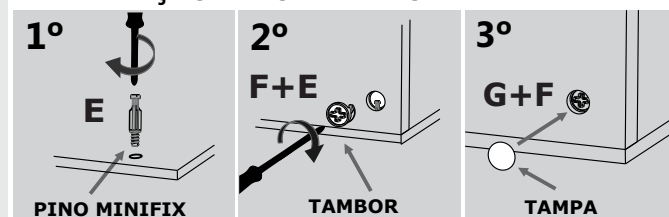

**1**

AS CORES APRESENTADAS NOS PASSOS SÃO MERAMENTE ILUSTRATIVAS.

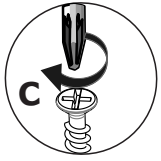
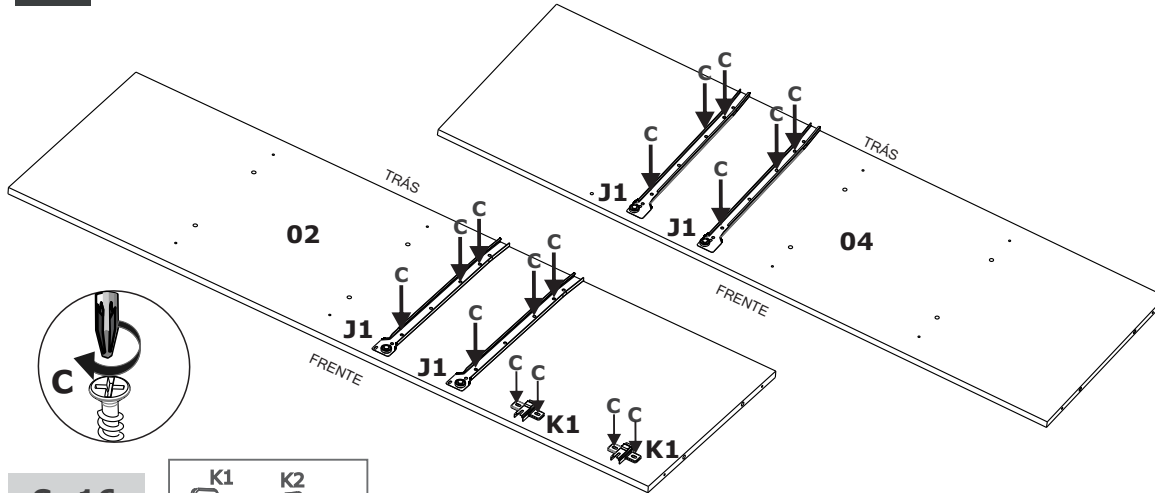

**C=16**  
**J1=04**  
**K1=02**

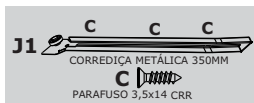
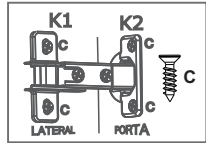
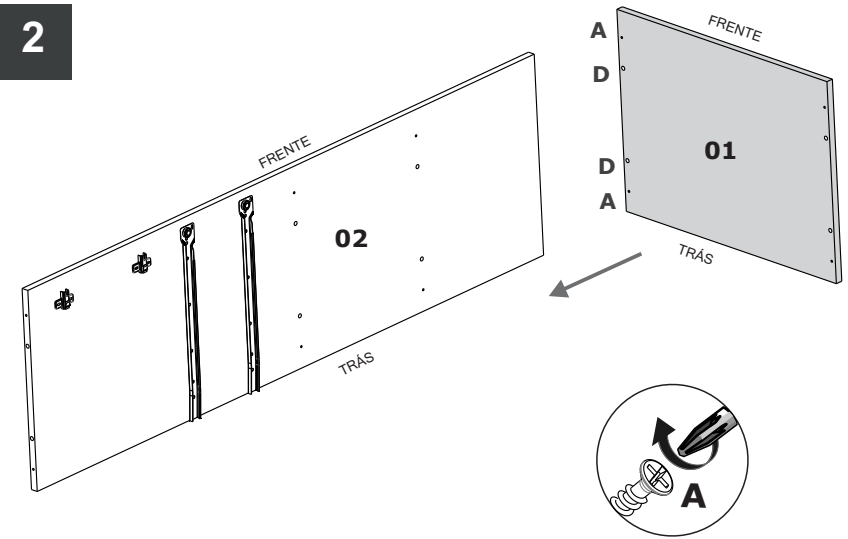
**2**

**A=02**  
**D=02**

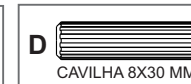
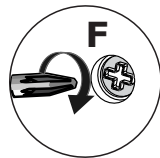
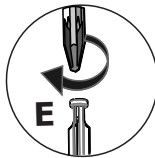
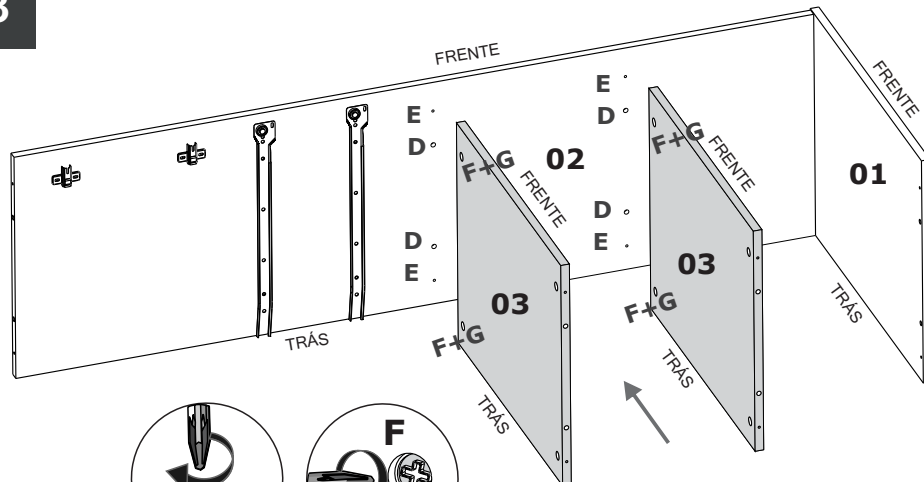
**3**

**D=04**  
**E=04**  
**F=04**  
**G=04**

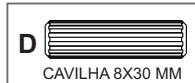
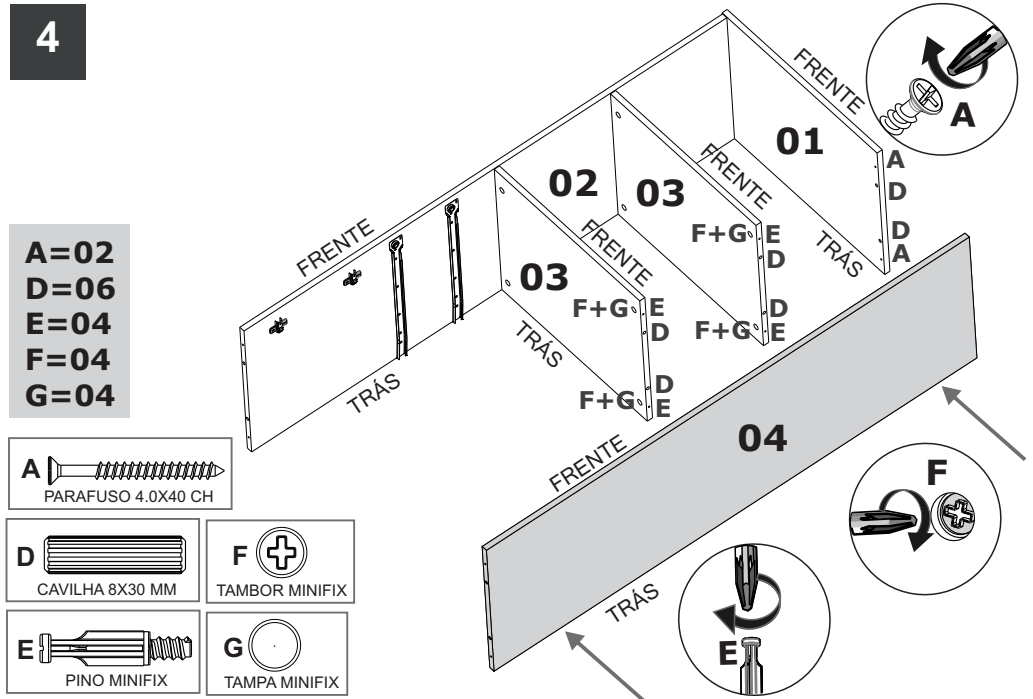
**4**

**A=02**  
**D=06**  
**E=04**  
**F=04**  
**G=04**

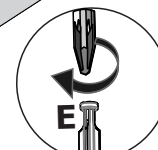
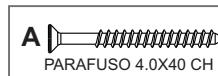

5

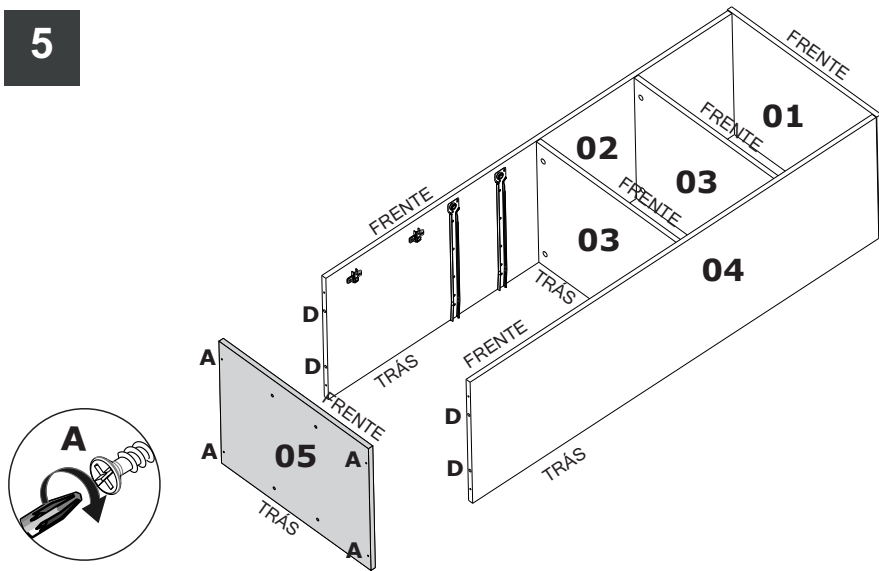

A=04  
D=04

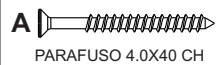

6

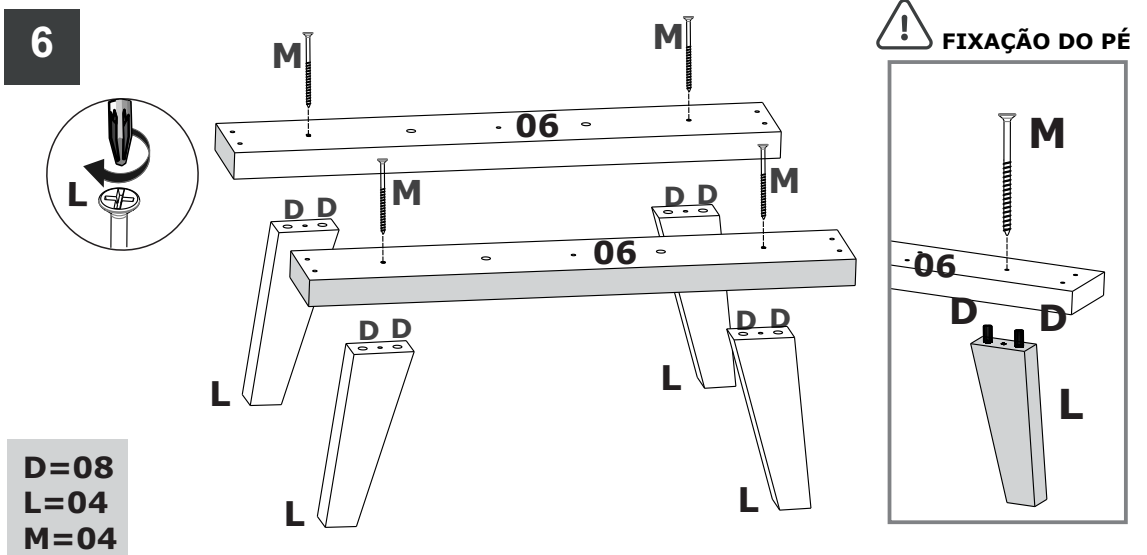

D=08  
L=04  
M=04

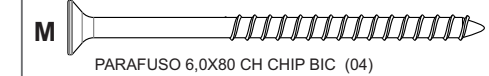

7

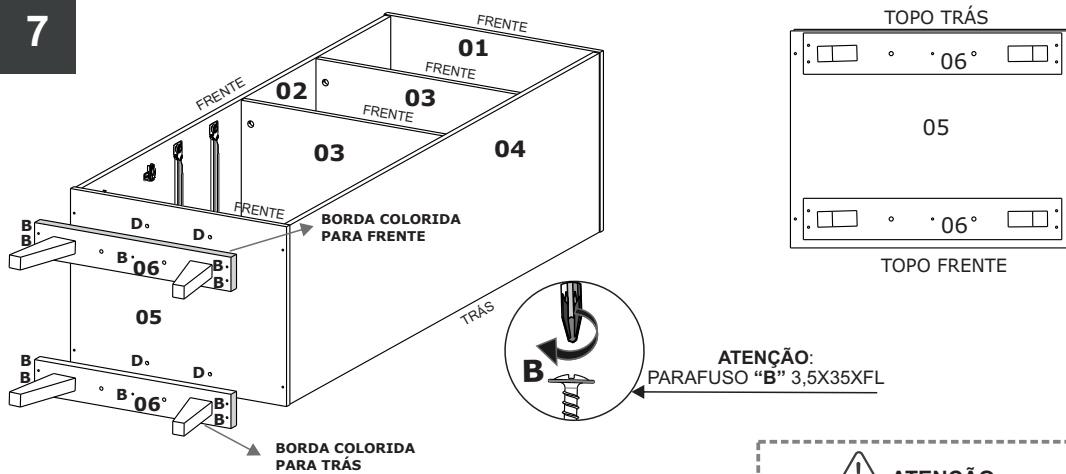

B=10  
D=04

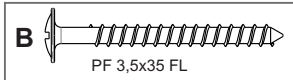

**ATENÇÃO**

UMA DAS PEÇAS 06 ENCAIXAR NA CAVILHA DA PEÇA 05 COM A BORDA COLORIDA PARA TRÁS.  
A OUTRA PEÇA 06 ENCAIXAR NA CAVILHA DA PEÇA 05 COM A BORDA COLORIDA PARA FRENTE.

8

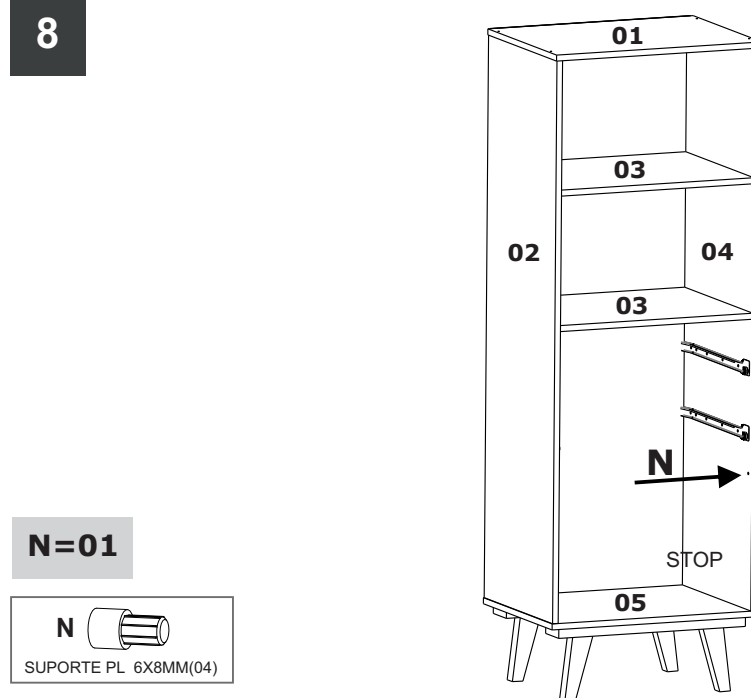

N=01

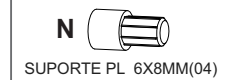

9

Encaixe do Perfil "O"

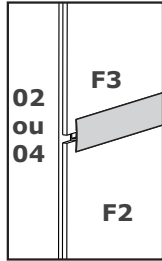

H=08  
I=60  
O=01

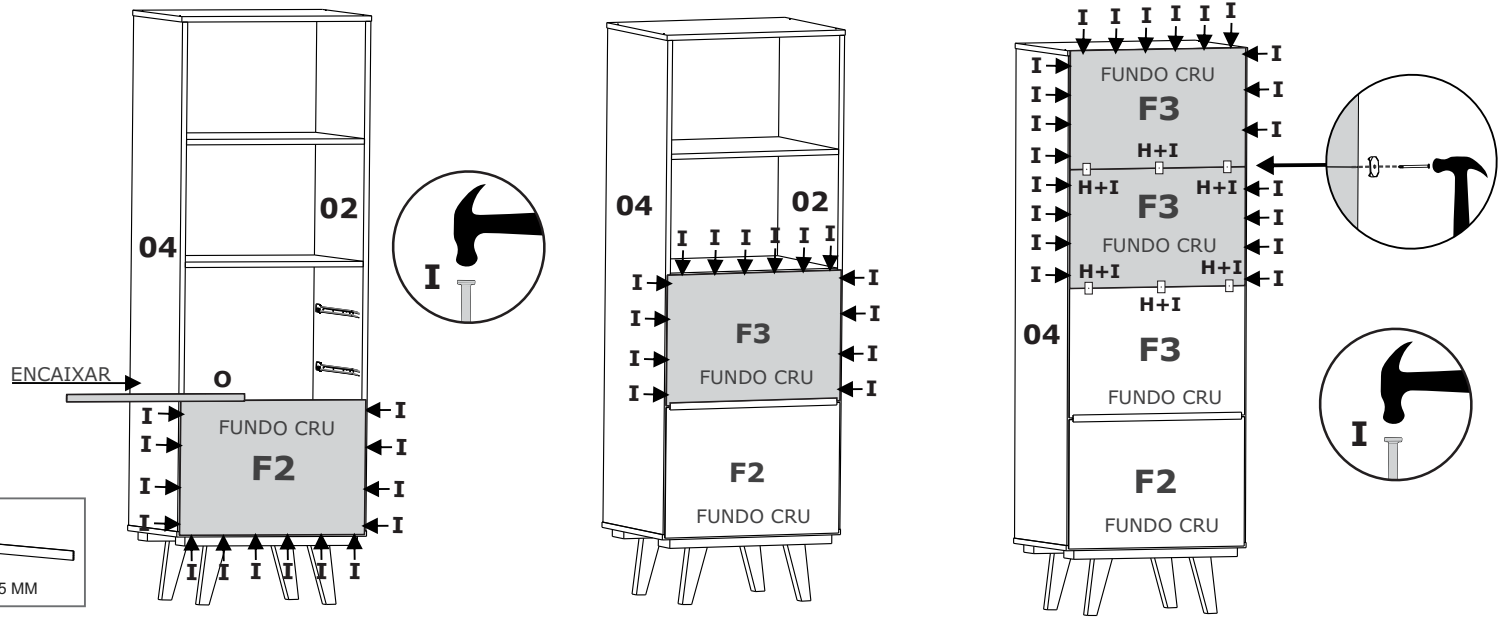

10

MONTAGEM DAS GAVETAS

1º

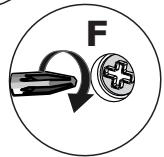
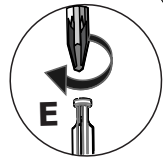
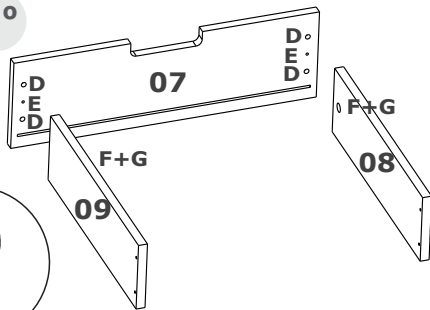

2º

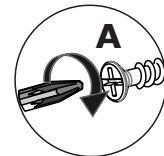
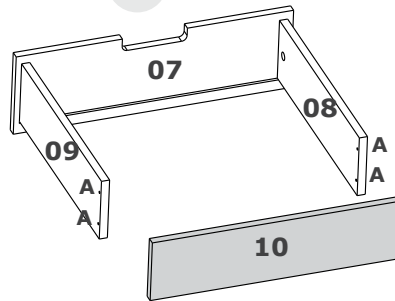

3º

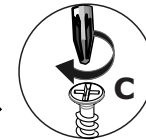
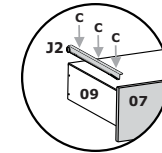
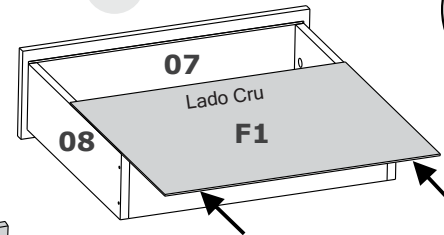

4º

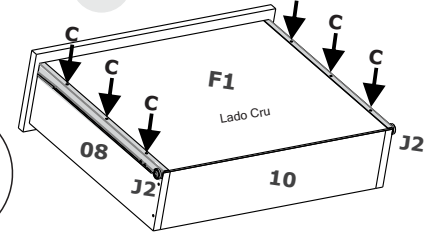

5º

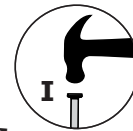
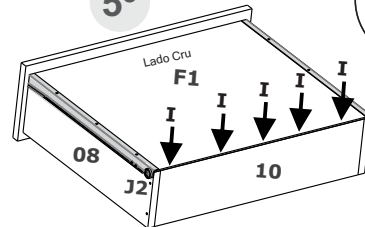

A=08  
C=12  
D=08  
E=04  
F=04  
G=04  
I=10  
J2=04

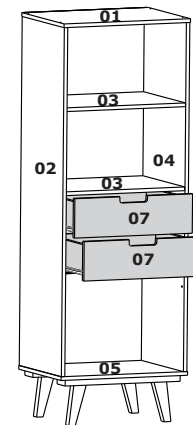
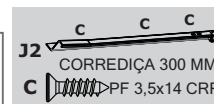
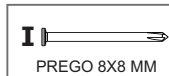
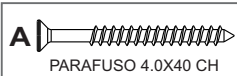

FIXAÇÃO DA DOBRADIÇA

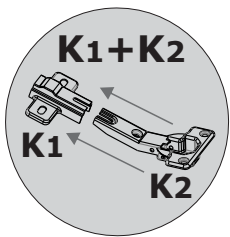
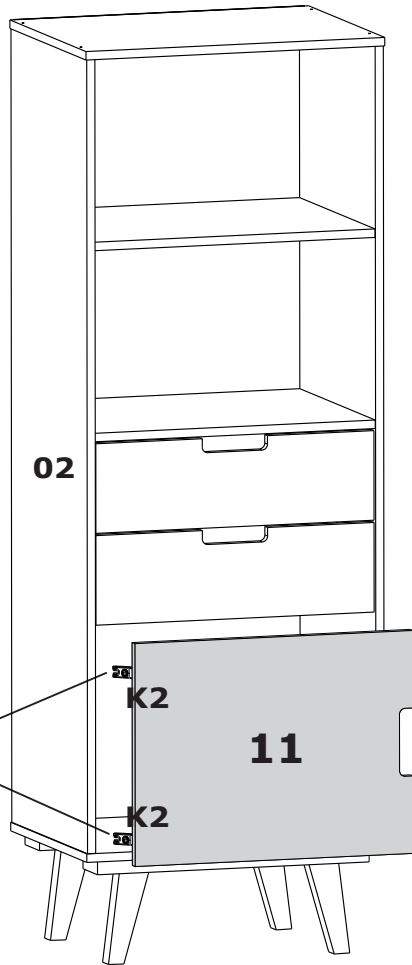
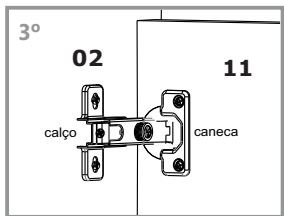
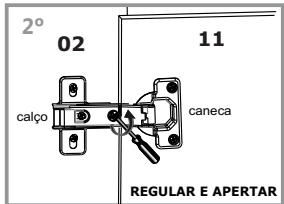
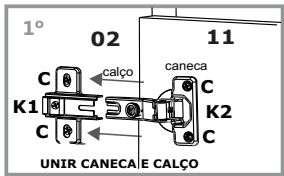

C=04  
K2=02

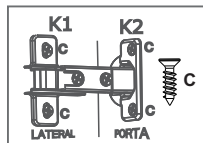
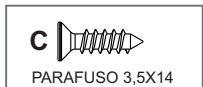

ATENÇÃO

SE TIVER CRIANÇAS EM CASA ACONSELHAMOS PARAFUSAR O PRODUTO NA PAREDE COM CANTONEIRAS, PARAFUSOS E BUCHAS (CONFORME O DESENHO), EVITANDO QUALQUER TIPO DE ACIDENTES.

