

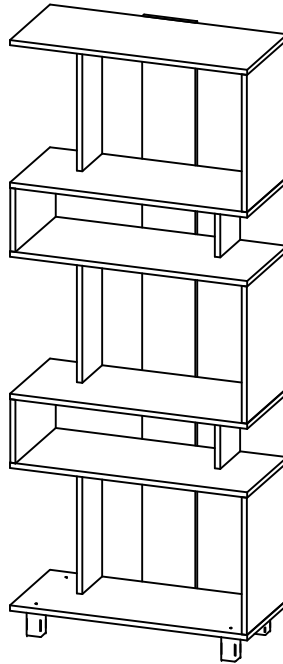







EF6600

Estante Forme

Instruções de montagem

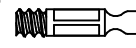
Assembly Instructions / Instrucciones de Montaje

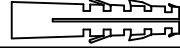

Lista de Ferragens		
Ref	Item	Qty
A	 Cavilha ø 6x30	38
B	 Parafuso CC 3,5x40	9
C	 Parafuso CF 5x50	5
D	 Parafuso Minifix	8
E	 Tambor Minifix	8
F	 Sapata 40x70	4
G	 Bucha Ø8mm	1
H	 COLA Cola	1

Nº	Peça	Medida	Qty
01	Base	670x300x15	1
02	Tampo	670x300x15	1
03	Prateleira Inferior	670x300x15	2
04	Prateleira Superior	670x300x15	2
05	Divisão Maior	385x300x15	3
06	Divisão Menor	178x300x15	2
07	Pilastra Maior	385x150x15	3
08	Pilastra Menor	178x150x15	2
09	Painel	1601x150x15	1

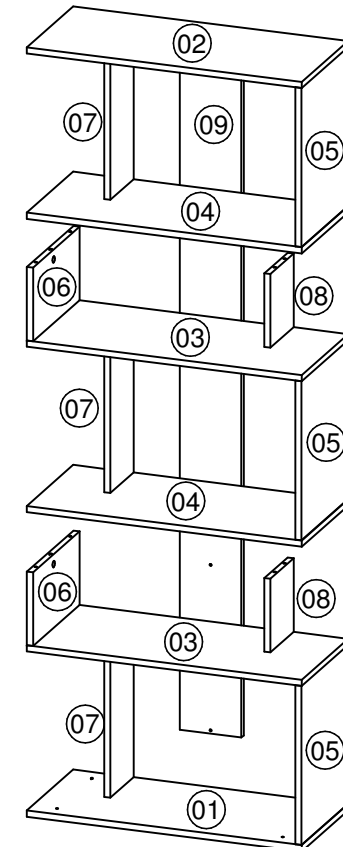

Ferramentas Necessárias:

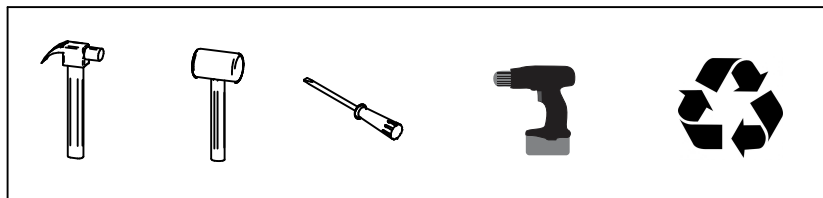

Antes de montar seu móvel, leia cuidadosamente o Manual de Instruções e o mantenha para futuras consultas.
OBRIGADO.

