

SERPIL

88 MÓVEIS

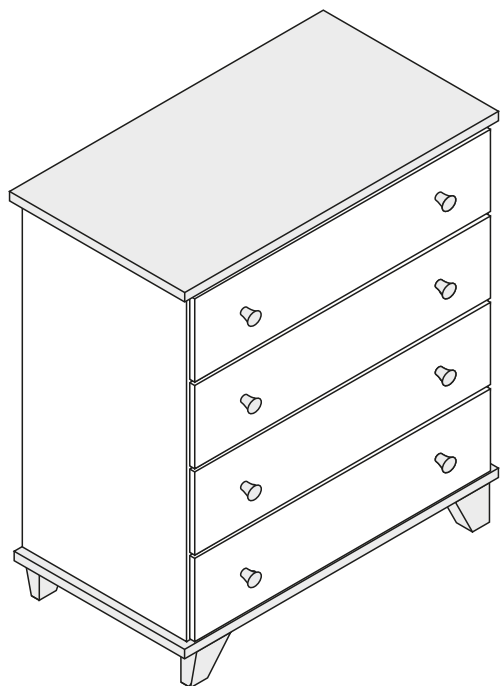

HUGS

Cômoda C-991

Bem-vindo

A Serpil traz até você soluções práticas de design com manuais de montagem e instalação detalhados para possibilitar o pleno aproveitamento do potencial dos produtos.

Para assegurar a garantia, é recomendada a prévia conferência de partes e componentes, bem como a leitura dos passos e suas ilustrações.

Preservar este documento é essencial para a adequada manutenção de seu móvel, o que engloba os possíveis ciclos de montagem e desmontagem.

Em caso de dúvidas, contate a Serpil que atende pelo fone 49.3366.6300 de Segunda a Sexta, das 7:30 às 11:45 e 13:30 a 18:00.

Recomendações

Para a montagem deste produto, são recomendadas 2 pessoas.

Os parafusos devem ser apertados periodicamente.

Evitar batidas e o contato com objetos cortantes.

Observar as cargas máximas suportáveis, quando houver, conforme o desenho esquemático no final do documento.

Partes do produto protegidas da incidência de luz estão sujeitas a alterações de tonalidade diferentemente das expostas. Somente o uso freqüente pode amenizar esta ocorrência.









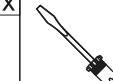
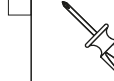

Algumas pinturas novas, embora atóxicas, podem apresentar odores. Para amenizá-los, mantenha o móvel em local arejado por aproximadamente três dias.

Manutenção e Limpeza

Pano levemente umedecido com água, seguido de flanela seca.

*Nunca utilizar produtos químicos ou abrasivos.

Abaixo sinalizadas, as ferramentas não fornecidas mas necessárias para a montagem do produto.

 Martelo Borracha	X	 Martelo	X	 Chave Phillips	X	 Chave Fenda		 Chave Phillips Pequena		 Chave Fenda Pequena	
 Furadeira com Broca de 5mm		 Chave de Boca de xxmm		 Trena	X	 Nível		 Escada		 Esquadro	

Partes do Produto

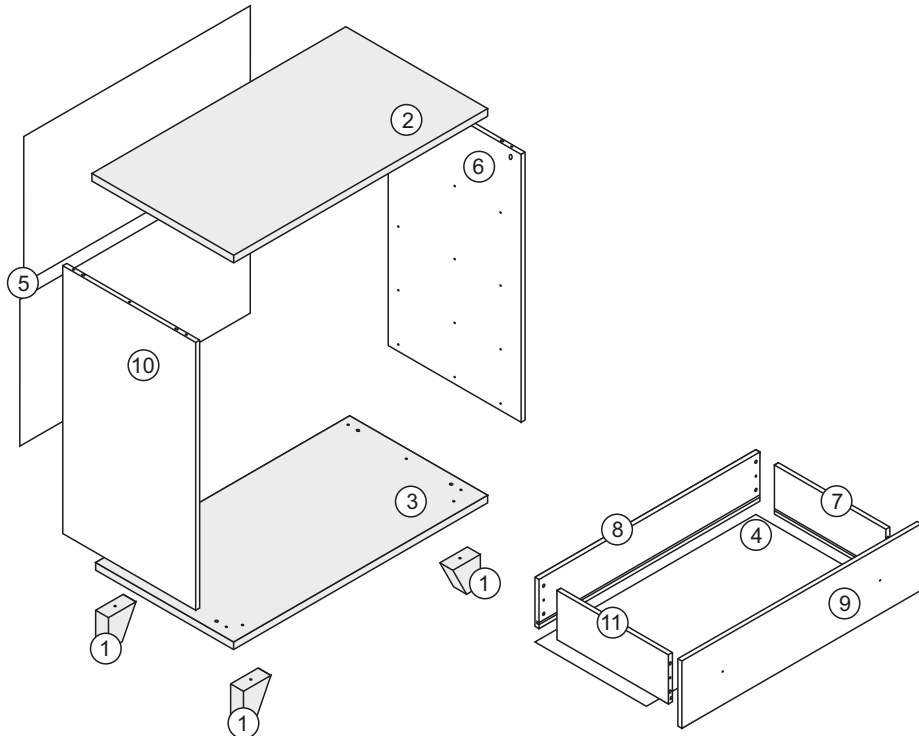

Nº	Item Desc.	Quantidade	Item
1	PE	4	6136
2	TAMPO	1	14836
3	BASE	1	14837
4	FUNDO GAVETA	4	14850
5	FUNDO	2	14851
6	LATERAL DIREITA	1	14852
7	LATERAL DIREITA GAVETA	4	14853
8	TRASEIRO GAVETA	4	14854
9	FRENTE GAVETA	1	14855
10	LATERAL ESQUERDA	1	14856
11	LATERAL ESQUERDA GAVETA	4	14868

Componentes

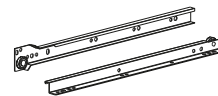

A- Corrediça
400mm (4xPar)



E- Pé Cônico
Madeira (4x)



C- Cola (1x)



D-Haste Minifix (12x)



E- Tambor
Minifix (12x)



F- Tapa Furo
18mm (8x)



G- Parafuso Chato
3 x 12mm (16x)



H- Parafuso Bujão
6 x 10mm (16x)



I- Puxador cônico
madeira (8x)



J- Cavilha
8x30mm (40x)



K- Prego 10 x 10mm
(25x)



L- Perfil H
743mm (1x)



M- Parafuso
Soberbo 5 x 50 (12x)



N- Chave Allen
3mm (1x)



O- Parafuso Chato
3,5 x 30mm (8x)

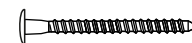

P- Parafuso
Soberbo 5 x 60 (4x)

Pré-Montagem

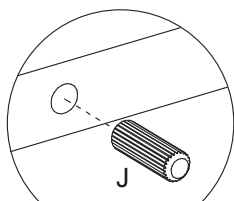
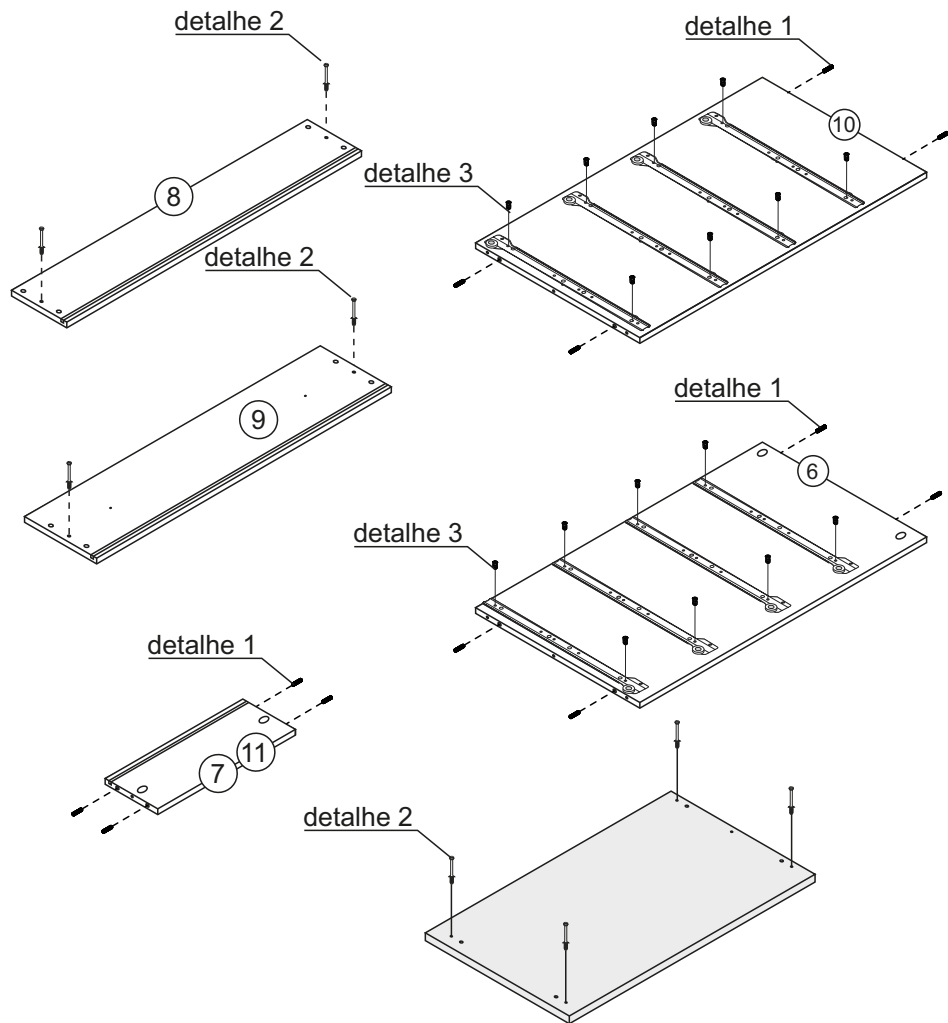

Detalhe 1

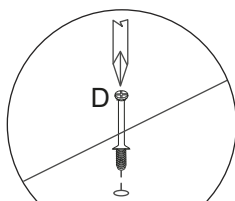

Detalhe 2

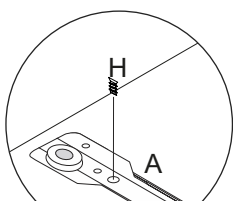

Detalhe 3

1

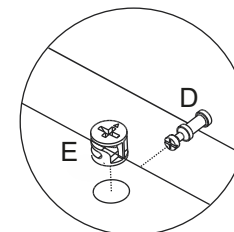
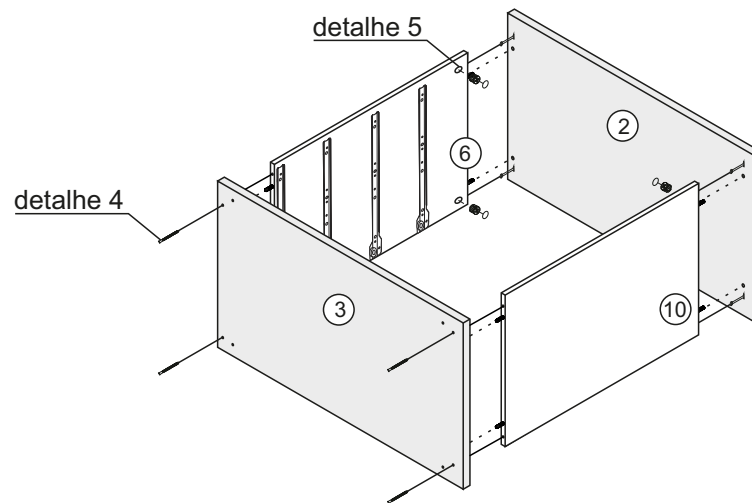
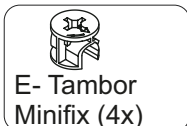
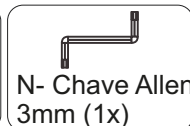
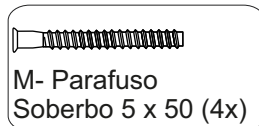

detalhe 5

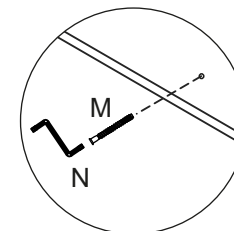

detalhe 4

2

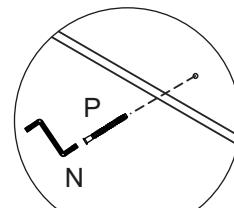
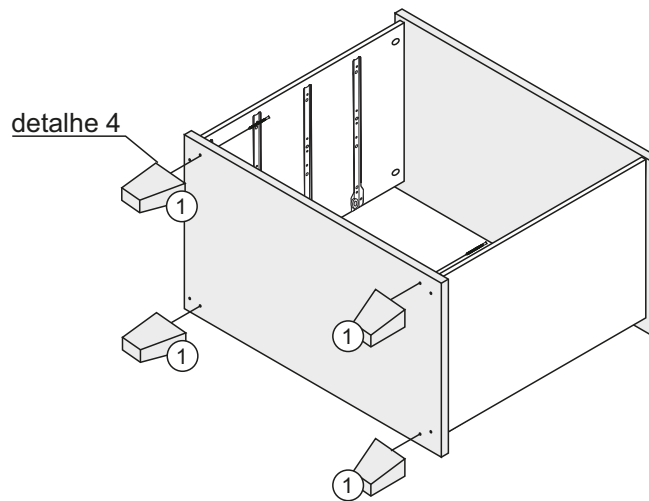
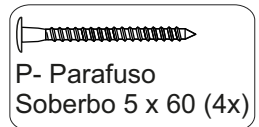

detalhe 4

3

 K- Prego 10 x 10mm
 (25x)

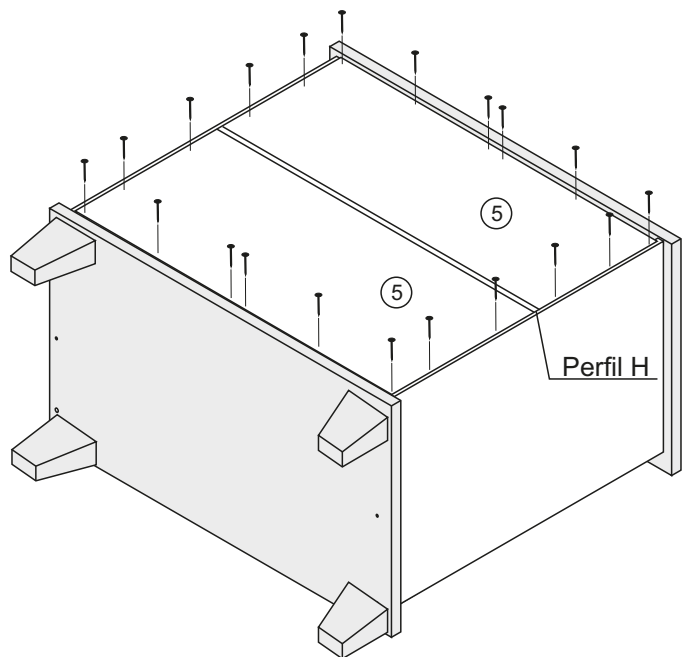

4



 A- Corrediça
 400mm (4xPar)



 E- Tambor
 Minifix (8x)

 G- Parafuso Chato
 3 x 12mm (16x)

 I- Puxador cônico
 madeira (8x)

 O- Parafuso Chato
 3,5 x 30mm (8x)

 M- Parafuso
 Soberbo 5 x 50 (8x)

 V- Chave Allen
 3mm (1x)

