

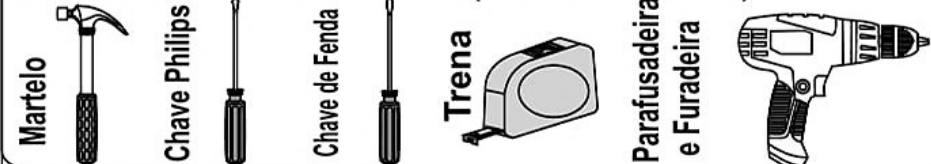

PANELEIRO DUPLO LUCCA / ANITA

Ferramentas Necessárias (Não Fornecidas)



ATENÇÃO:

1. Ler atentamente toda a instrução antes de iniciar a montagem do móvel.
2. A montagem deverá ser feita em superfície limpa e plana, aconselhamos

LIMPEZA E CONSERVAÇÃO

A limpeza do móvel deve ser efetuada **somente com pano macio e seco.**

Não utilizar produtos abrasivos ou similares, tais como:



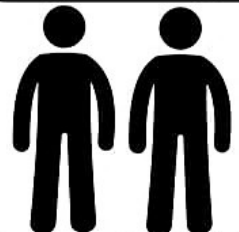



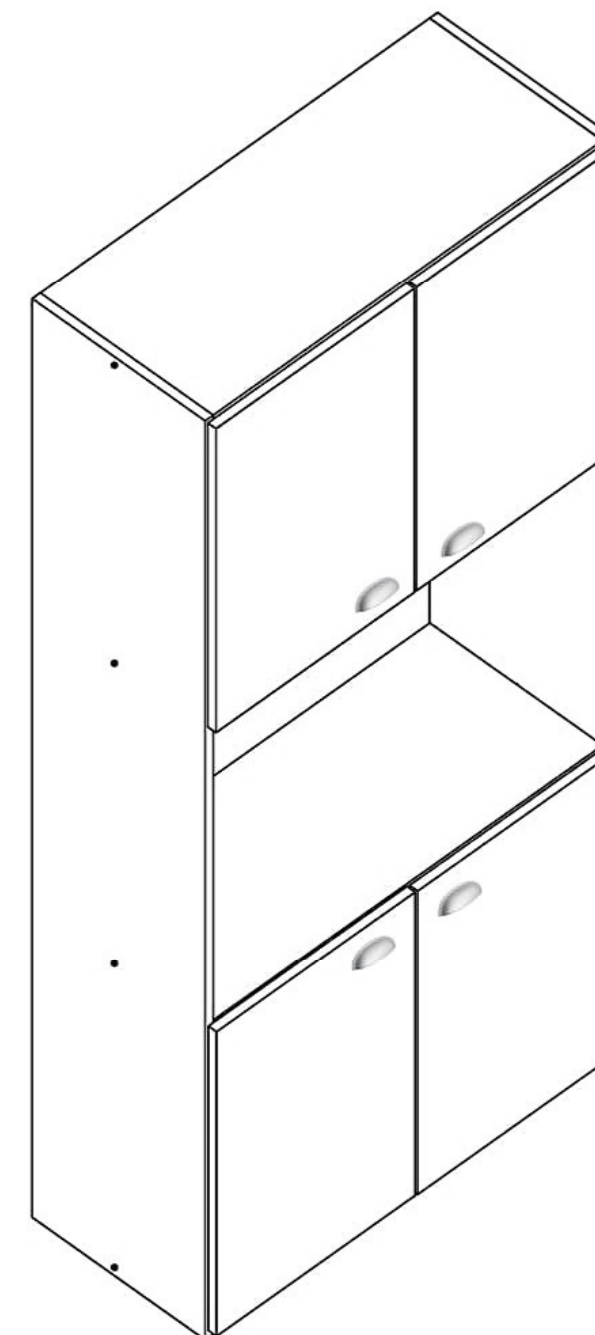
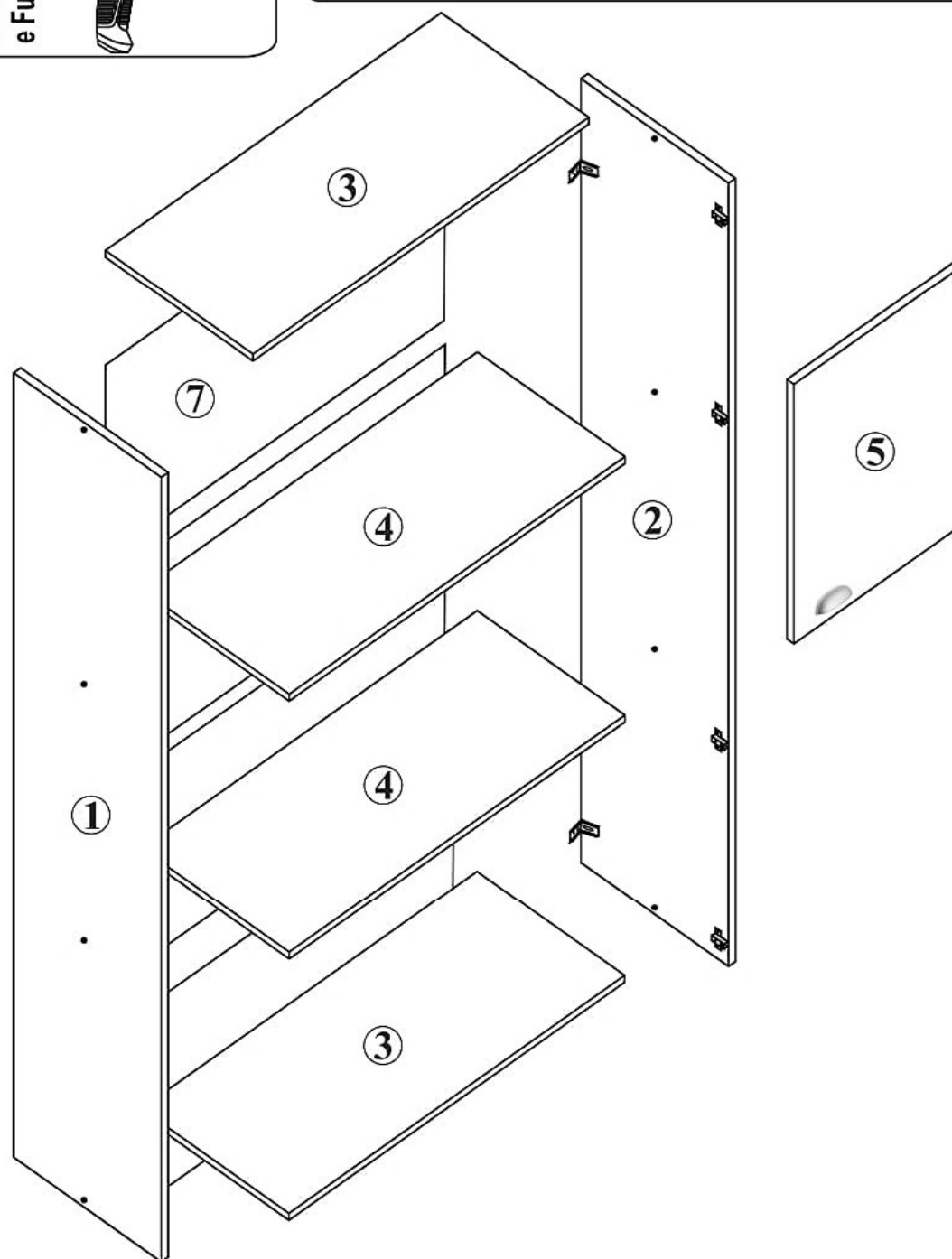

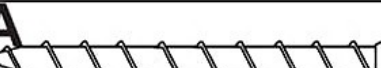
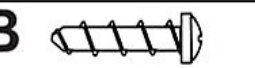

- .Cera;
- .Detergentes;
- .Lustra-móveis;
- .Álcool;
- .Tinner;
- .etc.

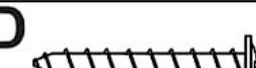
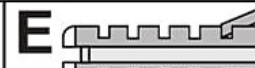
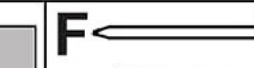

Necessário dois Montadores

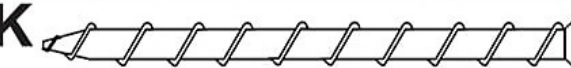

Nº	Característica	Mat/Prima	Medidas	Qtd	BRANCO	Int / Ext	BRANCO C/ PRETO	Int / Ext
01	Lateral Esquerda	Mdp	1355 x 255 x 12	01		B		
02	Lateral Direita	Mdp	1355 x 255 x 12	01		B		
03	Chapéu / Base	Mdp	580 x 255 x 12	02		B		
04	Prateleiras	Mdp	580 x 255 x 12	02		B		
05	Portas	Mdp	448 x 293 x 12	04		B		
06	Fundo	Mdf	457 x 297 x 2,8	04		B		

A  Parafuso C/ Chata 4,0 x 40 08 Unid.	B  Parafuso C/ Painel 3,5 x 12 44 Unid.	C  Puxador 04 Unid.	D  Parafuso C/ Flangeada 3,5 x 20 08 Unid.	E  Bucha 40 X 8 04 Unid.	F  Pregos 8 x 8 50 Unid.	G  Dobradiça 08 Unid.	H  Calço 08 Unid.	I  Calço Plástico 08 Unid.	J  Cantoneira de metal 55 x 27 x 27 04 Unid.
K  Parafuso Cabeça Painel 5,5 x 50 04 Unid.	L  Perfil H Plástico 457 x 18 x 6 02 Unid.	M  Cavilha de Madeira 6,0 x 30 16 Unid.	N  Capa Plástica da Cantoneira Branco 55 x 30 x 30 04 Unid.	 Medidas em mm					

FIXAÇÃO DOS ACESSÓRIOS

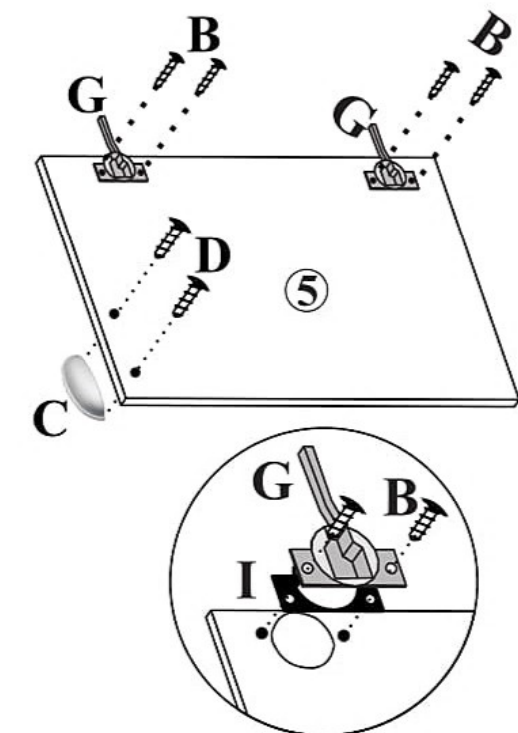
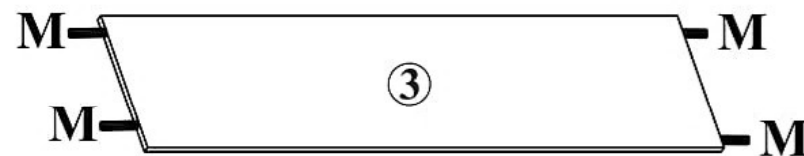
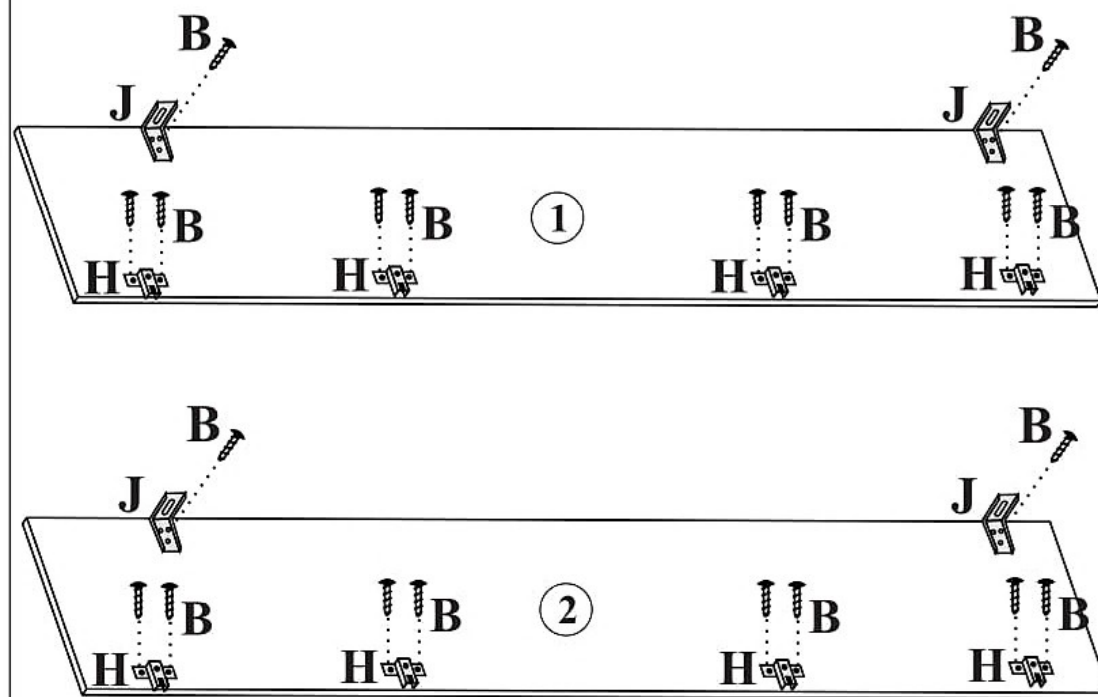

Montagem - Passo a Passo

ATENÇÃO: Sempre Montar o Produto conforme o Manual.

