

















LISTA DE PEÇAS / LISTA DE PIEZAS

ITM/C404 Rev.002

Item	Caixa	Qtd	Descrição / Descripción	Medidas (mm)
01	1/1	01	Base/ Base	800x310x15
02	1/1	02	Lateral Dir Esq/ Lado Dir Esq	270x295x15
03	1/1	01	Tampo/ Cubierta	800x310x15
04	1/1	01	Fundo/ Fondo	792x294x3
05	1/1	01	Porta basculante/ Puerta basculante	795x237x15

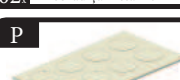
LISTA DE FERRAGENS

<b>A</b>  02. Paraf. 5,0x50mm FLA.	<b>B</b>  08. Paraf. 3,5x40mm CHT.	<b>C</b>  08. Paraf. 3,5x14mm FLA.	<b>D</b>  02. Batente PVC	<b>E</b>  04. Parafuso união 15mm
<b>F</b>  08. Cavilha 8x25mm	<b>G</b>  20. Prego 10x10	<b>H</b>  01. Puxador Alum MOV 795mm	<b>I</b>  01. Kit Pistão a gás 60N	<b>J</b>  02. Calço metal 12mm
<b>K</b>  02. Dobradiça metal 26mm	<b>L</b>  02. Bucha plástica 8mm	<b>M</b>  02. Suporte de fixação	<b>N</b>  02. Proteção p/ cantoneira	<b>O</b>  01. Sachê de cola
<b>P</b>  08. Adesivo tapa parafuso	<b>Q</b>  04. Parafuso união 30mm	<b>R</b>  03. Paraf. 3,5x12mm CHT		

AVISO

Para limpeza de seu móvel, use uma flanela seca ou umedecida, e não utilize produtos químicos que possam danificar seu produto.

SISTEMA DE MONTAGEM

O sistema de montagem dos produtos, funciona de acordo com a ordem crescente dos números indicados no desenho. Ex: 01, 02, 03, 04... até a conclusão da montagem.

ADVERTENCIA

Para limpieza de su móvil, use una flanela seca o húmeda, y no utilice productos químicos que puedan dañar su producto.

SISTEMA DE MONTAJE

El sistema de montaje de los productos funciona de acuerdo con el orden creciente de los números indicados en el dibujo. Ej.: 01, 02, 03, 04... hasta la conclusión del montaje.



O parafuso (Q) deve ser usada somente quando este módulo for acoplado a outro módulo componível Henn.



El tornillo (Q) se debe utilizar sólo cuando el módulo está conectado a otro módulo componible Henn.

RECOMENDAÇÃO

Para fixar o móvel na parede usar o suporte de fixação (M), o parafuso 3,5x14mm FLA (C), a Bucha 8mm (L) e o parafuso 5,0x50mm FLA (A).

RECOMENDACIÓN

Para conectar el móvil a la pared con el soporte (M), tornillo 3,5 x14mm FLA (C), el casquillo de 8 mm (L) y el 5,0 x50mm tornillo FLA (A).



www.henn.com.br  
henn@henn.com.br  
55 49 3674 3500  
Mondai/SC - Brasil

INSTRUÇÃO DE MONTAGEM  
INSTRUCCIONES DE MONTAJE

Aéreo 01 Porta Basculante 800mm Integra/ 01 Aerial Puerto Truck 800mm Integra

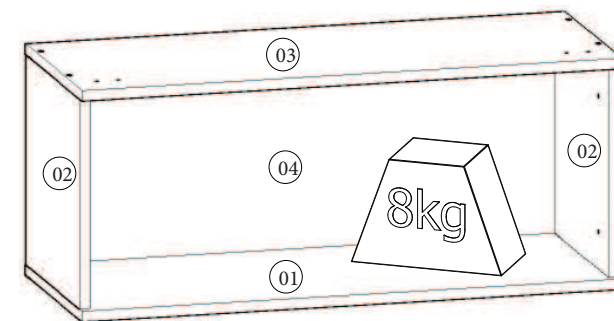
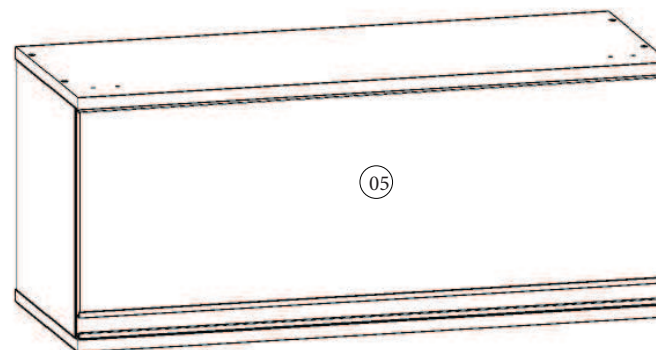

Pesos máximos recomendados com carga uniformemente distribuídas.

Peso máximo recomendado con la carga distribuida uniformemente.

- C404-94 - Rústico
- C404-96 - Rústico/Fendi

REQUISITOS PARA MONTAGEM  
REQUISITOS PARA LA MONTAJE

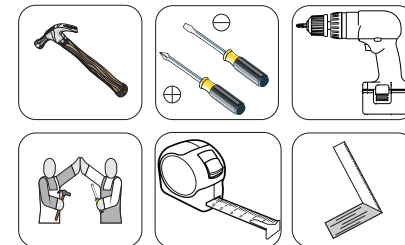

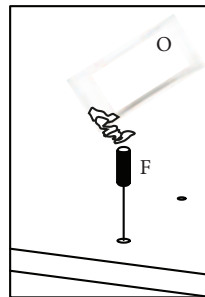
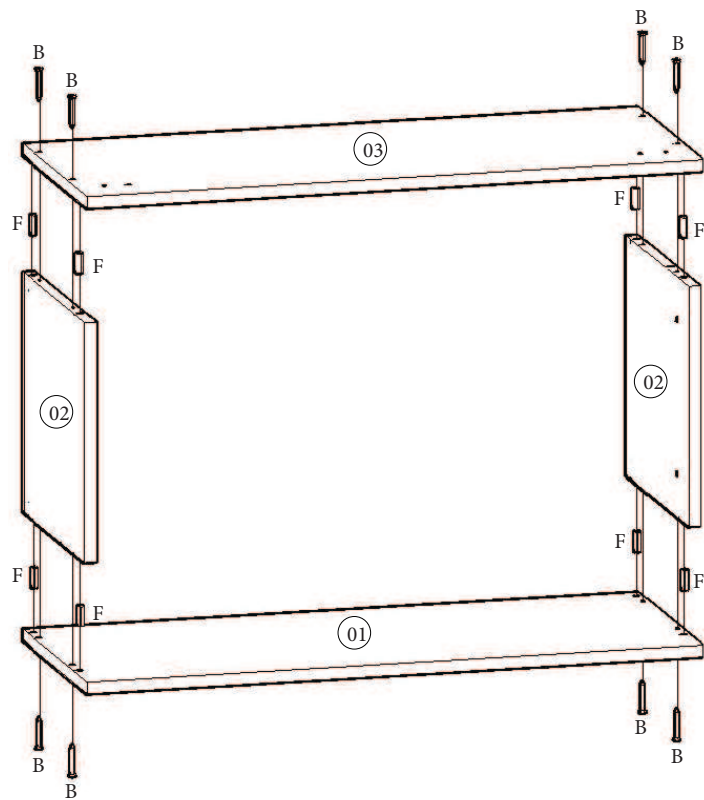

Utilizar o sachê de cola (O) em todas as cavilhas (F) do produto.

Con el pegamento sobre (O) en todos los pernos (F) producto.

