

MANUAL DE MONTAGEM

ATENÇÃO:

- 1 - Ler atentamente todo o manual antes de iniciar a montagem do móvel.
- 2 - A montagem deve ser feita em uma superfície plana e limpa.
- 3 - Recomenda-se utilizar a embalagem do móvel para forrar e chão e assim não danificá-los

LIMPEZA E CONSERVAÇÃO:

A limpeza do móvel deve ser feita com utilização de pano umedecido com água, podendo conter uma pequena quantidade de álcool. Não utilize produtos abrasivos.

GARANTIA:

90 dias para defeitos de fabricação.

Quantidade de pessoas
necessárias para montar o
móvel

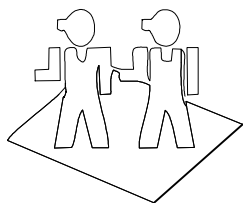



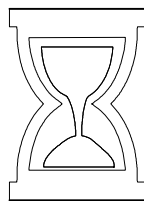

Tempo necessário para a
montagem: 1h

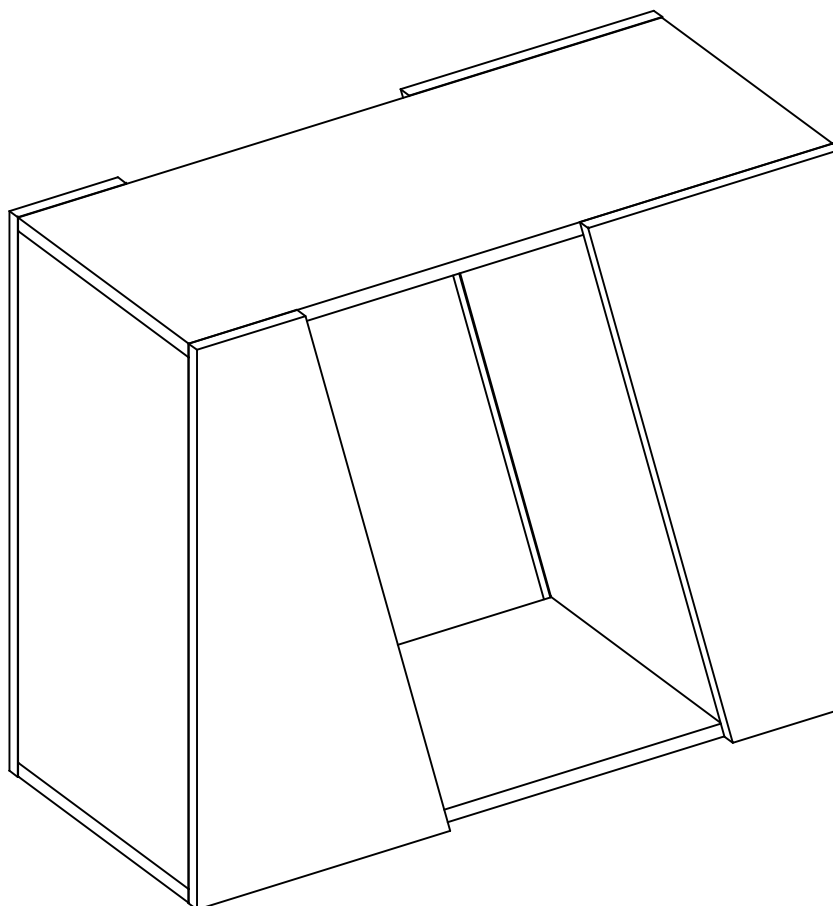
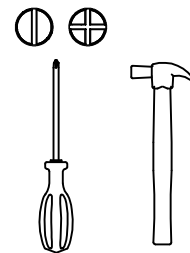

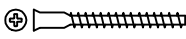

Ferramentas necessárias

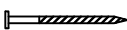

Lista de peças						
Código de assistência	Descrição	Quant.	Compr. (mm)	Larg. (mm)	Espes. (mm)	Caixa/ volume
01	Base	1	890	364	18	A
02	Tampo	1	890	364	18	A
03	Laterais	4	740	505	18	A
04	Divisória externa	2	703	364	18	A
05	Divisória interna	2	728	364	18	A

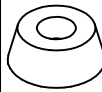
Ferragem			
	Código de assistência	Descrição	Quant.
A	3682	 Parafuso philips 5,0x50	32
B	4214	 Parafuso chato 3,5x14 cabeça rebaixada	8
C	85	 "L" de metal	4
D	9623	 Batente de silicone	4
E	149	 Pregão 13 x 15	4

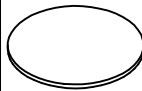
F	1901	 Sapata deslizadora preta	4
H	58	 Etiqueta marca "Kappesberg"	1
I	41	 Cola branca em bisnaga (10g)	1
J	44669	 Tapa furo adesivo 13mm walnut	32



