

MANUAL DE MONTAGEM

ATENÇÃO:

- 1 - Ler atentamente todo o manual antes de iniciar a montagem do móvel.
- 2 - A montagem deve ser feita em uma superfície plana e limpa.
- 3 - Recomenda-se utilizar a embalagem do móvel para forrar e chão e assim não danificá-los

LIMPEZA E CONSERVAÇÃO:

A limpeza do móvel deve ser feita com utilização de pano umedecido com água, podendo conter uma pequena quantidade de álcool. Não utilize produtos abrasivos.

GARANTIA:

90 dias para defeitos de fabricação.

Quantidade de pessoas
necessárias para montar o
móvel

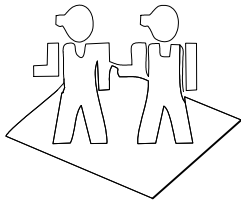

Tempo necessário para a
montagem: 1h30min





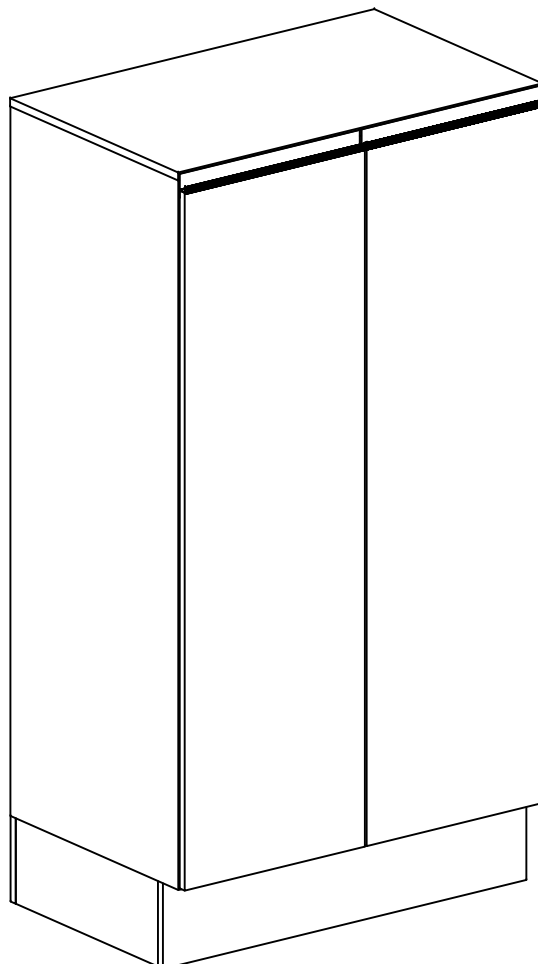
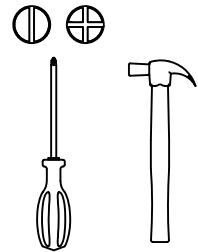







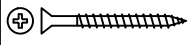
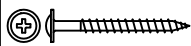

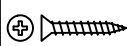
Ferramentas necessárias











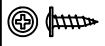
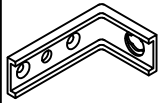
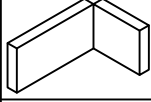

Lista de peças

Código de assistência	Descrição	Quant.	Compr. (mm)	Larg. (mm)	Espes. (mm)	Caixa/ volume
01	Lateral direita	1	1325	496	15	A
02	Lateral esquerda	1	1325	496	15	A
03	Base	1	770	496	15	B
04	Prateleiras	3	770	430	15	B
05	Chapéu	1	801	496	15	B
06	Travessa superior	1	770	80	15	B
07	Rodapé lateral	2	420	160	15	B
08	Rodapé frontal	1	799	160	15	B
09	Rodapé traseiro	1	799	160	15	B
10	Portas	1	1303	396	15	A
11	Costas	4	790	332	3	B

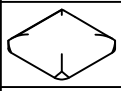
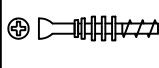
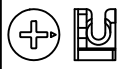
Ferragem

	Código de assistência	Descrição	Quant.
A	226	 Parafuso chato 4,0x40 bicromatizado	8
B	95	 Parafuso flange 5,0x50 zincado branco	5
C	4214	 Parafuso chato 3,5x14 cabeça rebaixada	28
D	491	 Parafuso chato 4,0x25 bicromatizado	4
E	1802	 Cavilha 6x30mm	30
F	107	 Pregão 10 x 10	66
G	149	 Pregão 13 x 15	4
H	899	 Cantoneira de metal	4
I	41	 Cola branca em bisnaga (10g)	1
J	85	 "L" de metal	4
K	44886	 Puxador aluminio maxxi 396mm bronze	2
L	1901	 Sapata deslizadora preta	4
M	58	 Etiqueta marca "Kappesberg"	1

N	40736	 NO=Tapa furo adesivo 13mm Nogal	12
N	36059	 AM=Tapa furo adesivo 13mm Amendoa	12
O	25827	 Parafuso flange 3,5x14 zincado branco	4
P	17024	 Suporte aéreo metalizado zincado branco	2
Q	6959	 Capa para suporte aereo metal branca	2
R	529	 Bucha ivasa	5
S	7787	 Dobradiça reta 35	6
T	7787	 Calço para dobradiça	6
U	7787	 Parafuso panela 4,0x14 para dobradiça	24
V	40534	 Batente de silicone incolor	4
W	30945	 Minifix (parafuso)	6
X	30950	 Minifix (tambor)	6
Y	44792	 AM=Tapa furo adesivo 19mm Amendoa	6
Y	44741	 NO=Tapa furo adesivo 19mm Nogal	6
Z	1423	 Fixador de costa	23

Acessório com parafusos e dobradiças (saco médio)



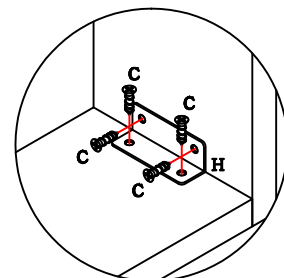
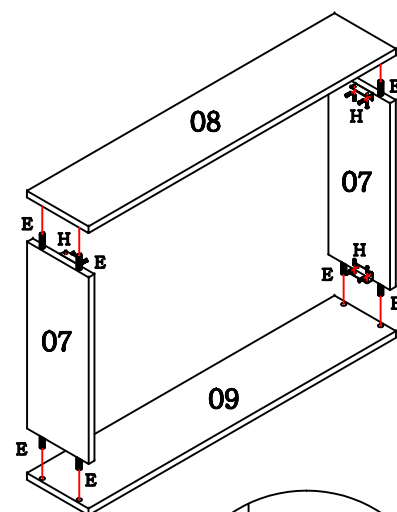
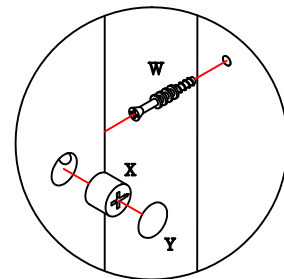
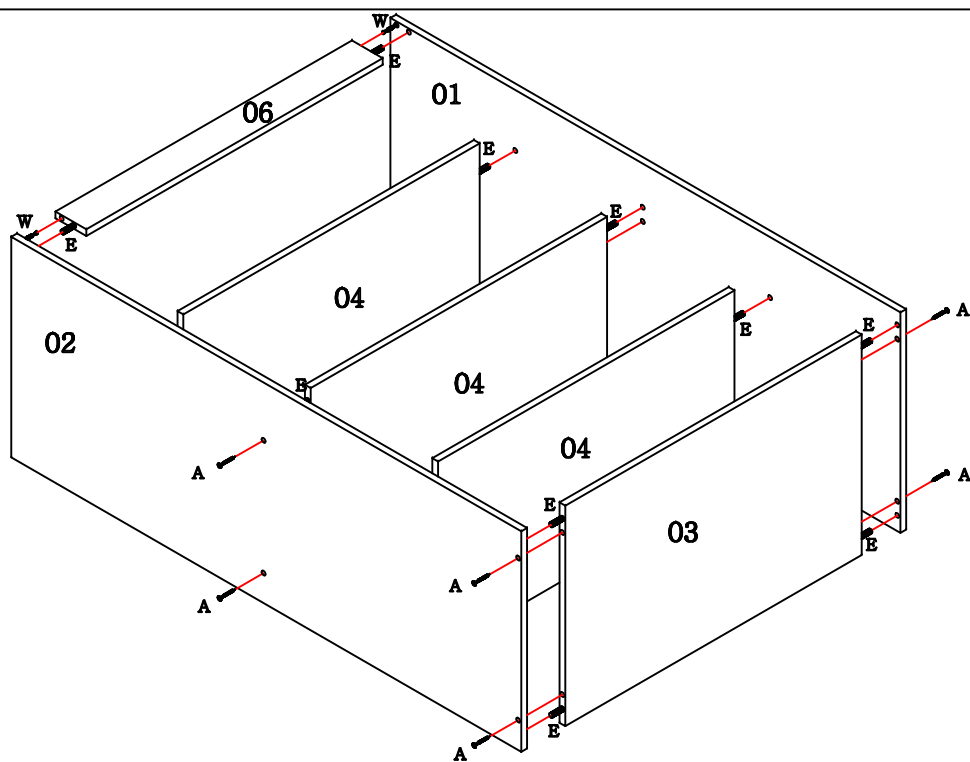

Fixe os rodapés com as cantoneiras "H" pelo lado interno.

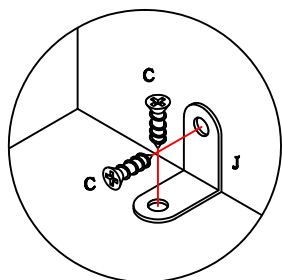
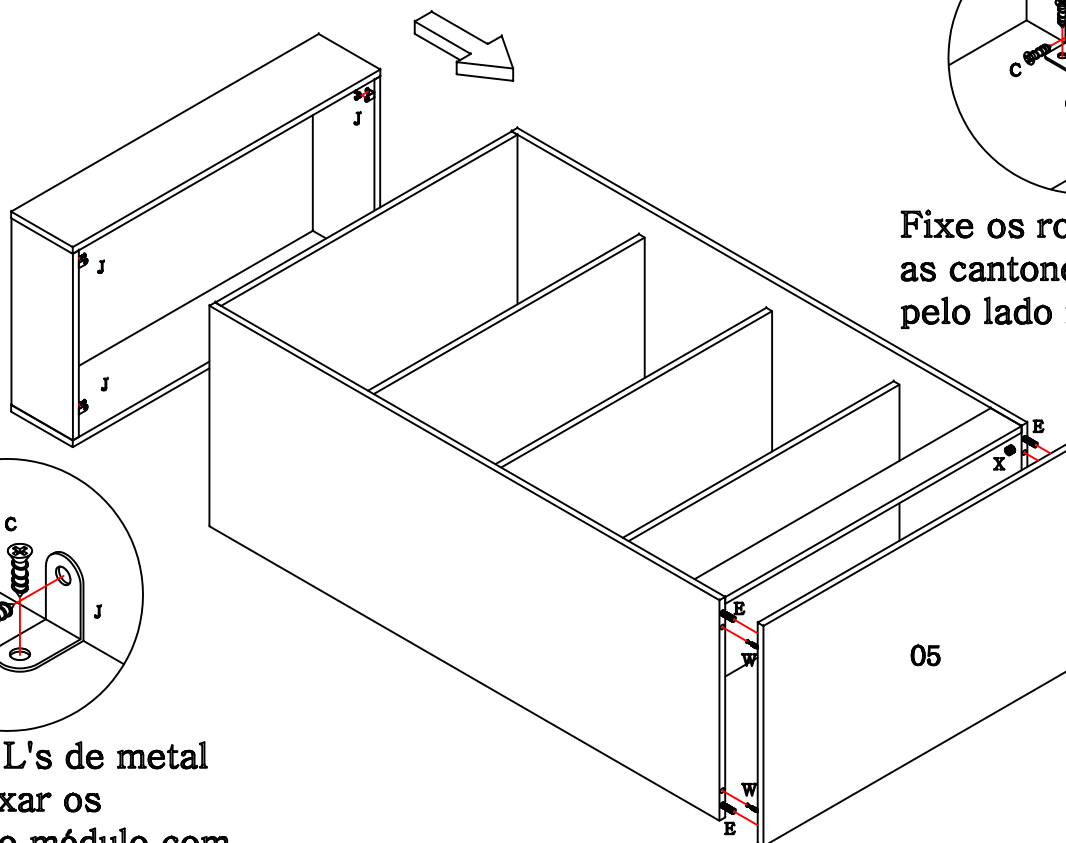

Utilize os L's de metal "J" para fixar os rodapés no módulo com os parafusos "C".

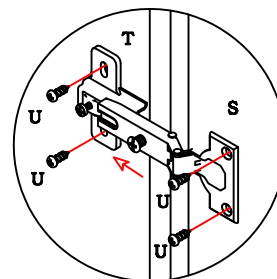
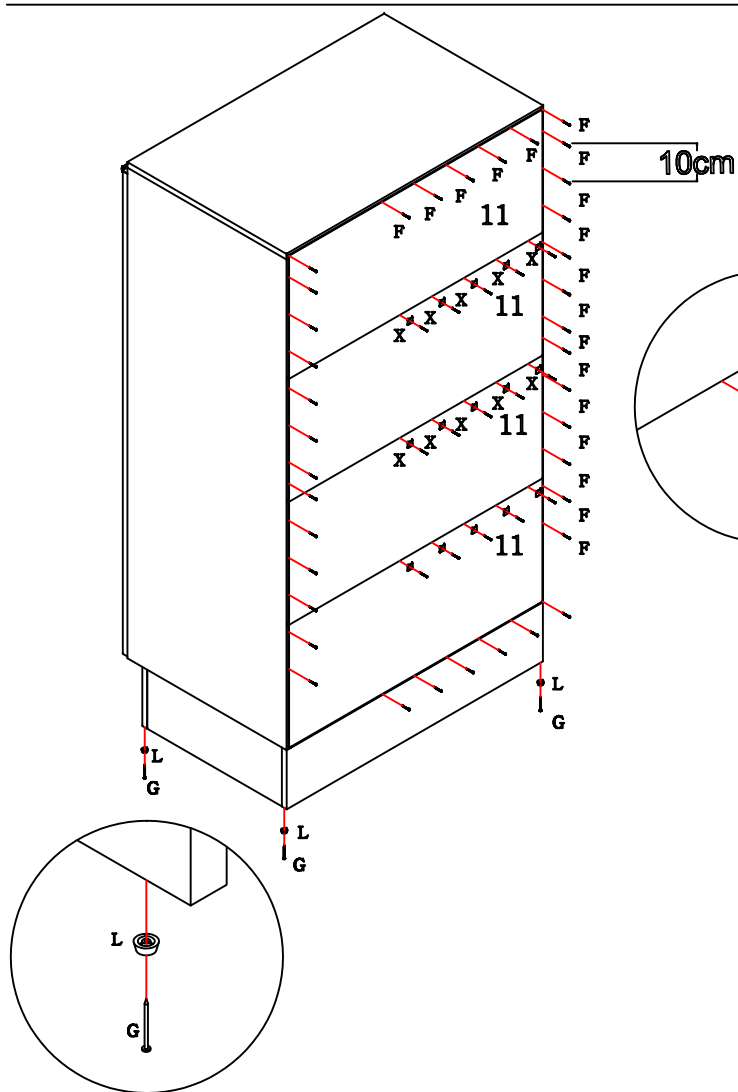

A dobradiça "S" deve ser encaixada no calço "T" e estes colocados com os parafusos "U", observando o procedimento a cima.

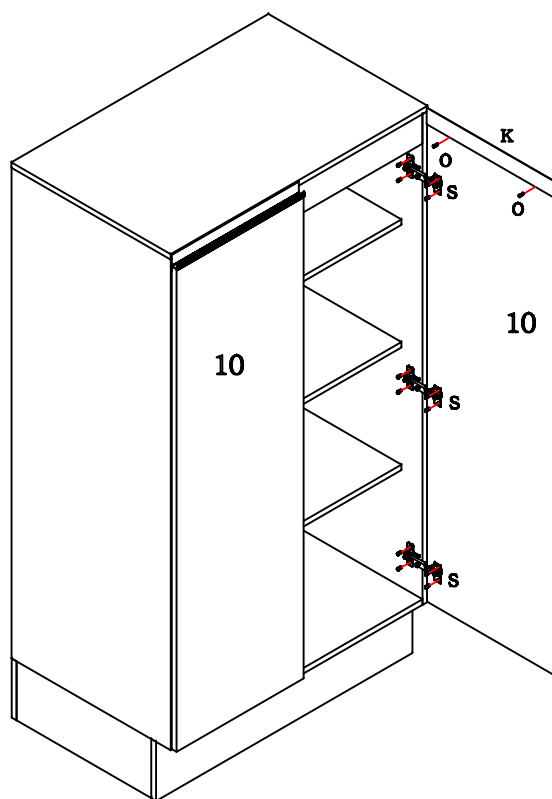

As batentes de silicone "V" são colocadas na porta, para suavizar eventuais impactos.

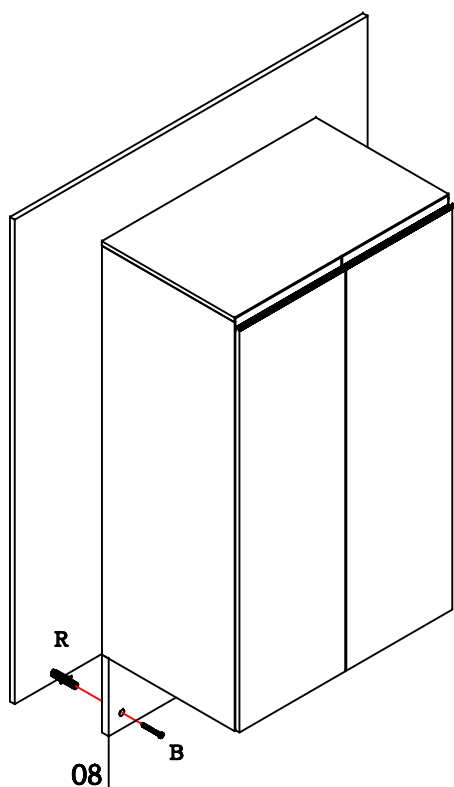

Utilize o parafuso "D" para fixar um módulo em outro.

Para montar a cozinha suspensa:

- Utilize o rodapé frontal "08" que acompanha o móvel como apoio para sua fixação na parede, utilizando a bucha "R" e o parafuso "B".
- Em cada lateral fixe um suporte aéreo metalizado "P" com o parafuso "C" e na parede com o parafuso "B" e com a bucha "R".
- Coloque uma capa "Q" em cada suporte "P".