

# INSTRUÇÃO DE MONTAGEM

## MULTIUSO PARIS

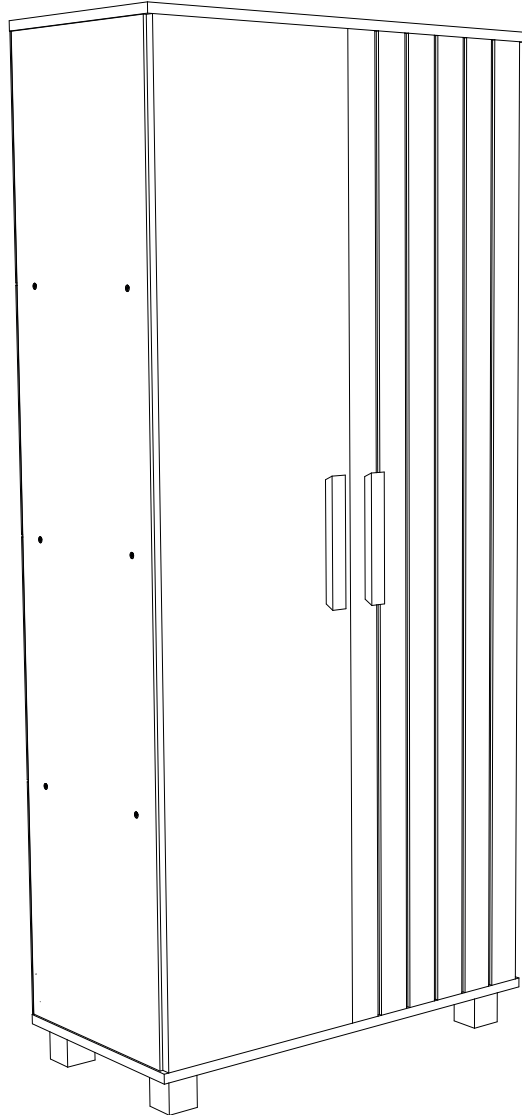

Você vai precisar de:

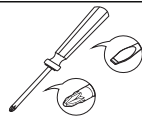

Parafusadeira

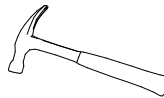

Martelo

### ATENÇÃO:

- 1 - Ler e observar toda a instrução de montagem antes de iniciar a montagem.
- 2 - A montagem do produto deverá ser feita em uma superfície limpa e plana. Aconselhamos usar a embalagem para forrar o chão a fim de não danificar o produto.
- 3 - Os parafusos devem ser apertados periodicamente.
- 4 - Evitar batidas e contatos com objetos cortantes.







### LIMPEZA

- 1 - Pano levemente umedecido com água, seguido de pano seco.
- 2 - Não utilizar produtos químicos ou abrasivos.

## RELAÇÃO DE PEÇAS

COD.	DESCRIÇÃO	MEDIDAS CASAL(mm)	QUANTIDADE
01	FUNDO TRASEIRO	695 x 353 x 15	04
02	LATERAL DIREITA	1500 x 345 x 12	01
03	LATERAL ESQUERDA	1500 x 345 x 12	01
04	PORTA DIREIRA	1490 x 342 x 15	01
05	PORTA ESQUERDA	1490 x 342 x 15	01
06	PRATELEIRA	670 x 345 x 12	03
07	BASE/TAMPO	700 x 360 x 15	02

## RELAÇÃO DE ACESSÓRIOS

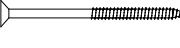
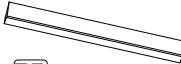
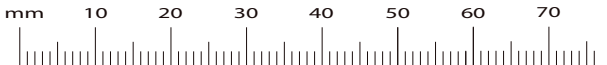
 <b>A</b> 24x Parafuso Escariado PHS 5,0 X 50	 <b>B</b> 06x Dobradiça com Calço 26mm	 <b>C</b> 20x Cavilha 6,0 x 30	 <b>D</b> 50x Pregos 10 x 10	 <b>G</b> 03x Perfil H 1500mm	 <b>H</b> 24x Parafuso Chato 3,5 X 12
 <b>I</b> 04x Pé de Madeira	 <b>J</b> 04x Parafuso Chato 3,5 X 25	 <b>K</b> 02x Puxador Madeira	Use a Escala (Régua) abaixo para medir os parafusos e acessórios. Coloque-os encima da escala para verificar o tamanho correto indicado.		
					

### Explodido

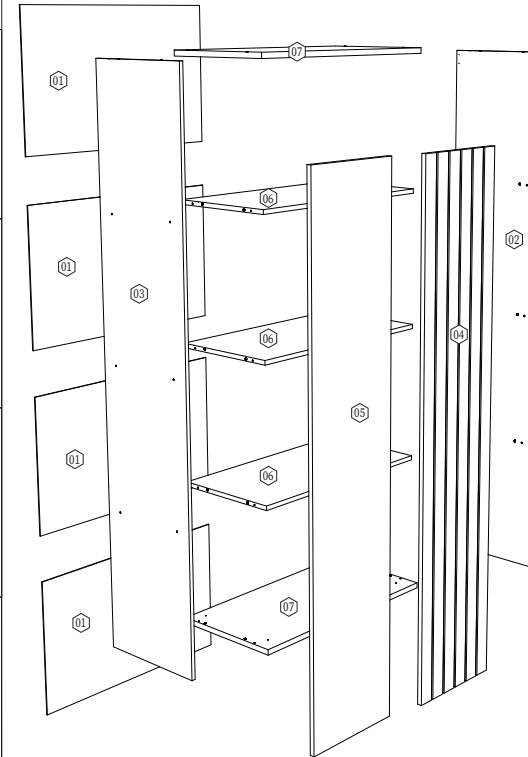

### Preparação das Peças

02 LATERAL DIREITA  
03 LATERAL ESQUERDA

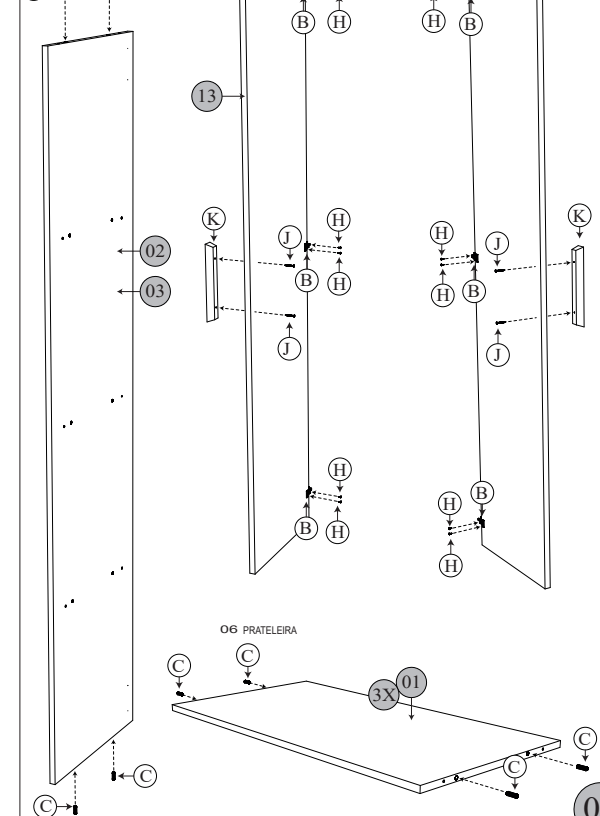

PASSO 1 - MONTAGEM DA BASE.

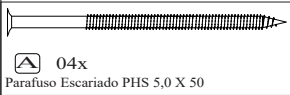
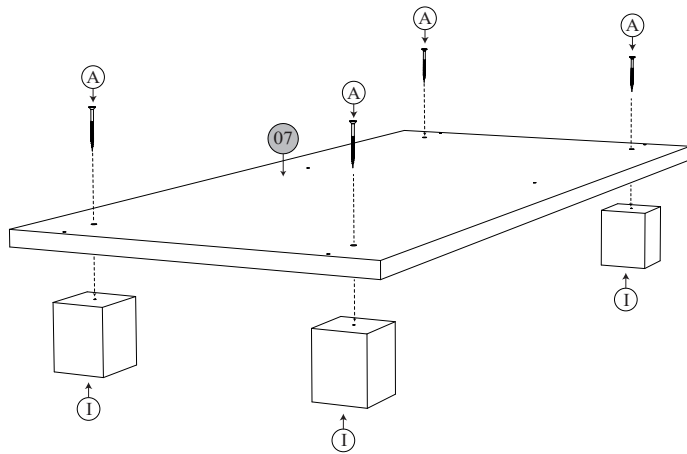

PASSO 4 - MONTAGEM DAS PRATELEIRAS

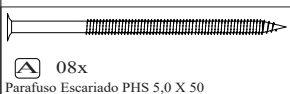
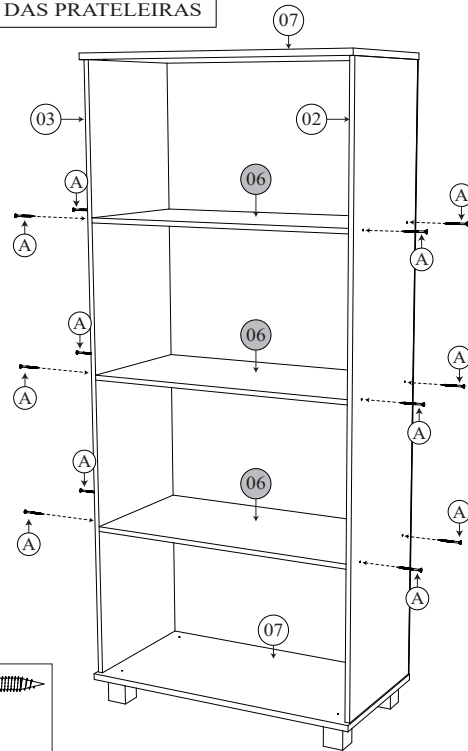

PASSO 2 - MONTAGEM DAS LATERAIS.

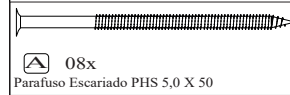
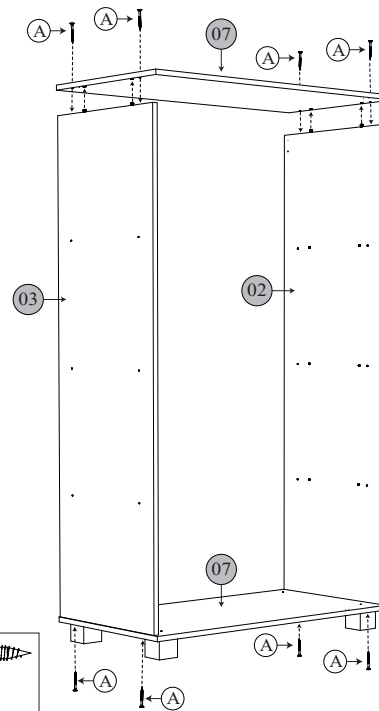

PASSO 5 - MONTAGEM DA PORTA DIREITA.

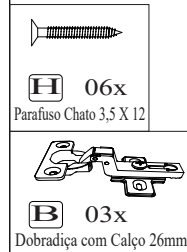
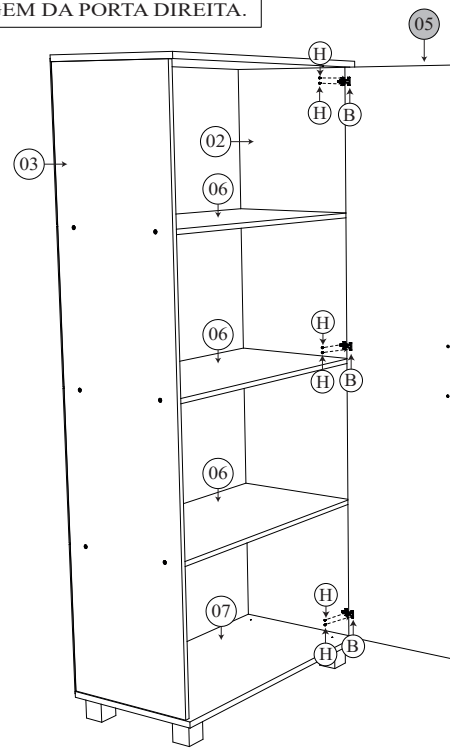

PASSO 3 - MONTAGEM DO FUNDO TRASIERO.

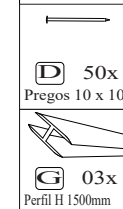
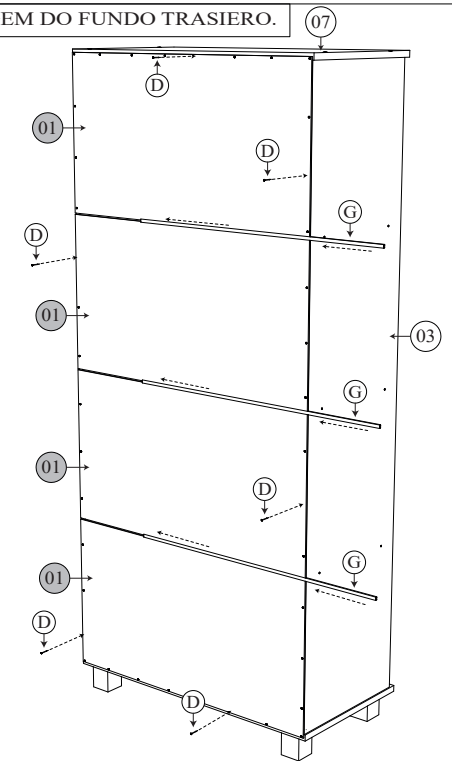

PASSO 2 - MONTAGEM DO FUNDO TRASIERO.

