



SALLÊTO IND. E COM. DE MÓVEIS LTDA.

Tel./Fax: (32) 3541-6777

Av. Jesus Candian, 800 - Cx Postal 116

B. Mangueira Rural - CEP 36500-000 - Ubá - MG

Site: www.salletomoveis.com.br - E-mail: salletomoveis@salletomoveis.com.br

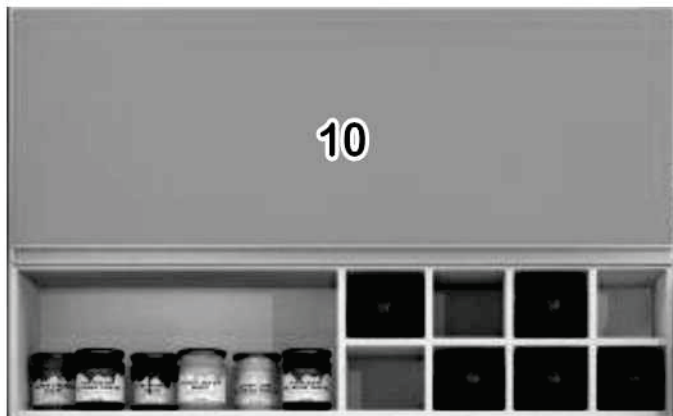

## Aéreo Carrara

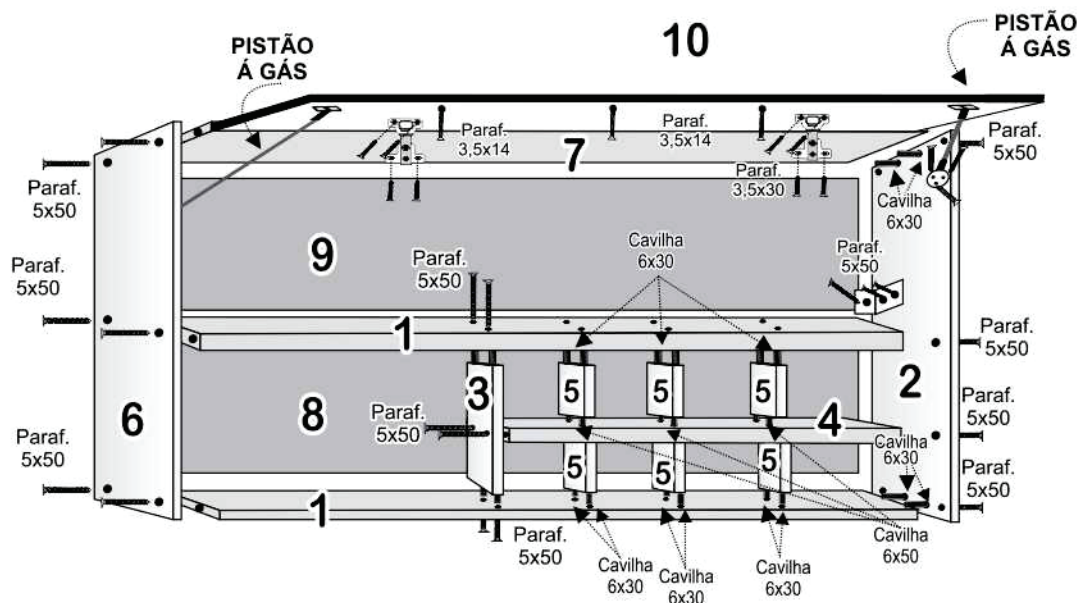

COD.	Componentes do Aéreo Carrara	Quant. Peças
6849	01 - Base Tampo da Adega	02
6847	02 - Lateral Direita	01
6850	03 - Divisão Maior da Adega	01
6851	04 - Prateleira da Adega	01
6852	05 - Divisões Menor da Adega	06
6848	06 - Lateral Esquerda	01
6983	07 - Tampo Superior	01
6854	08 - Costa Inferior Menor	01
6855	09 - Costa Superior Maior	01
6853	10 - Porta Bâscula	01

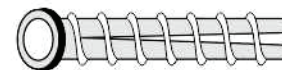
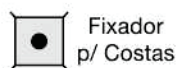

Bucha 8mm p/ parede  
Usar Paraf. 5x50 - Flangeado



*Jesus Salva*

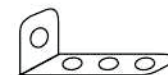

Cantoneira p/ parede  
Usar Paraf. 5x50 - Flangeado





**SALLÊTO IND. E COM. DE MÓVEIS LTDA.**  
 Tel./Fax: (32) 3541-6777  
 Av. Jesus Candian, 800 - Cx Postal 116  
 B. Mangueira Rural - CEP 36500-000 - Ubá - MG  
 Site: www.salletomoveis.com.br - E-mail: salletomoveis@salletomoveis.com.br

*Jesus Salva*

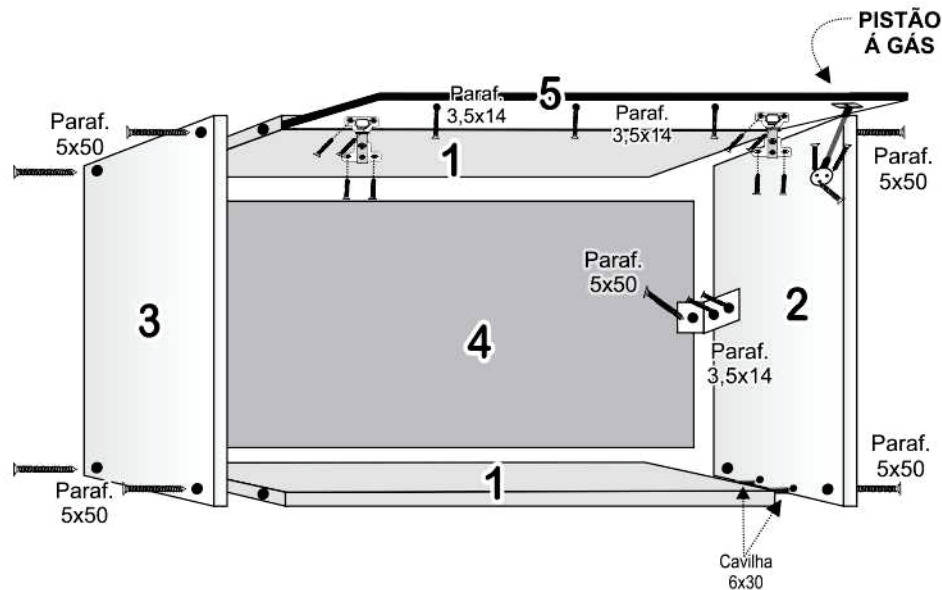

COD.	Componentes do Kit Aéreo Geladeira Carrara / Florença	Quant. Peças
6858	01 - Tampo / Base	02
6856	02 - Lateral Direita	01
6857	03 - Lateral Esquerda	01
6860	04 - Costa	01
6859	05 - Porta	01



## Kit Aéreo Geladeira Carrara

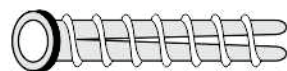

Bucha 8mm p/ parede  
Usar Paraf. 5x50 - Flangeado

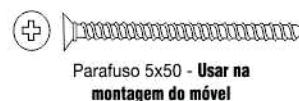

**SENHOR MONTADOR PARA FAZER A UNIÃO DOS MODULOS FAVOR USAR O PARAFUSO 3,5x30 ONDE FOR PRECISO**



SALLÊTO IND. E COM. DE MÓVEIS LTDA.

Tel./Fax: (32) 3541-6777

Av. Jesus Candian, 800 - Cx Postal 116

B. Mangueira Rural - CEP 36500-000 - Ubá - MG

Site: www.salletomoveis.com.br - E-mail: salletomoveis@salletomoveis.com.br



## Paneleiro Duplo Florença

### Componentes do Paneleiro Duplo Florença

COD.	Componentes
6913	01 - Base
6911 6912	02 - Laterais
6914	03 - Prateleiras Tampo
6917	04 - Costa Inferior Menor
6916	05 - Costa Superior Maior
6915	06 - Portas

### Quant. Peças

01	Paraf. 5x40
02	5x40
05	
01	
01	
04	

