

Ref.1264 Estante multifuncional 4 portas de clique MDF UV

Alt.1805 Larg.1245 Prof.300mm

Ferragem		
A	 Cavilha 8 x 30 mm	56
B	 Minifix 6 x 32 mm	44
C	 Tambor 15 x 11 mm	44
D	 Tampa Adesiva 19 mm	44
E	 Parafuso 3,5 x 14 CC	64
F	 Parafuso 4,5 x 45 CC	02
G	 Bucha 8mm	02
H	 Cantoneira 30 x50	02
I	 Sapata 15 x 60 mm	06
J	 Pregos 10 x 10mm	100
K	 Fixador de costas	30
L	 Cantoneira 13 x 13	06
M	 Fecho toque cermag (com parafusos 3,5 x12)	04
N	 Dobradiça curva com amortecedor can.35mm	04
O	 Dobradiça super curva com amortecedor can.35mm	04

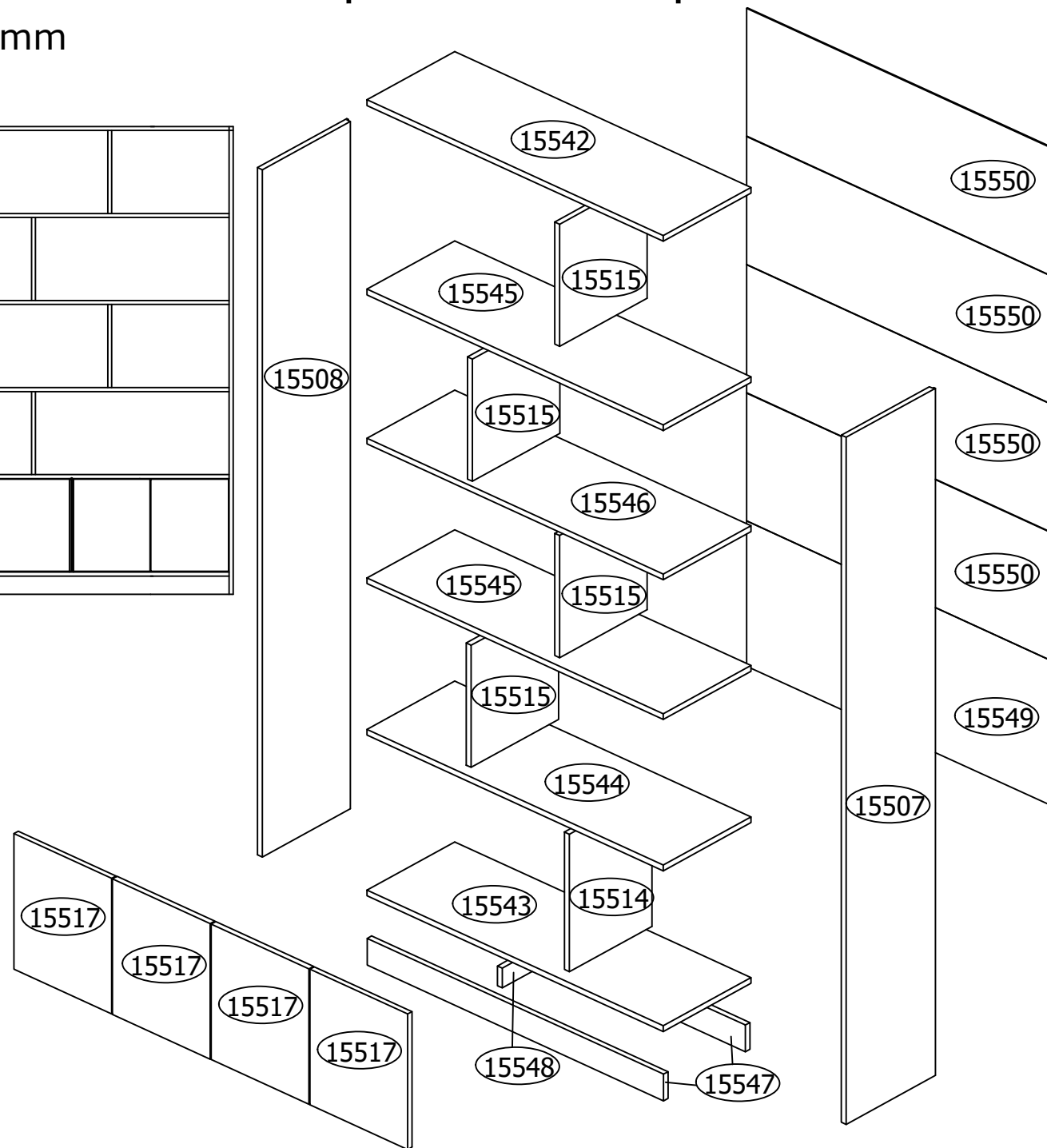
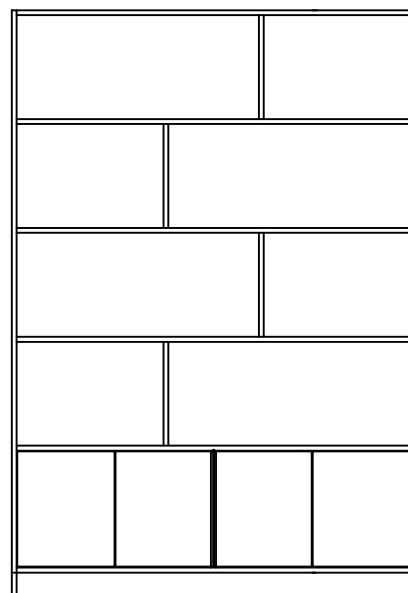

Ordem Nº Descrição

Ref.1264 Estante

1º Passo 1/4

- 1 15507 Lateral direita
- 2 15543 Base inferior
- 3 15514 Divisória inferior
- 4 15544 Tampo
- 5 15515 Divisória superior
- 6 15545 Prateleira superior
- 7 15515 Divisória superior
- 8 15546 Prateleira superior
- 9 15515 Divisória superior
- 10 15545 Prateleira superior
- 11 15515 Divisória superior
- 12 15542 Base superior

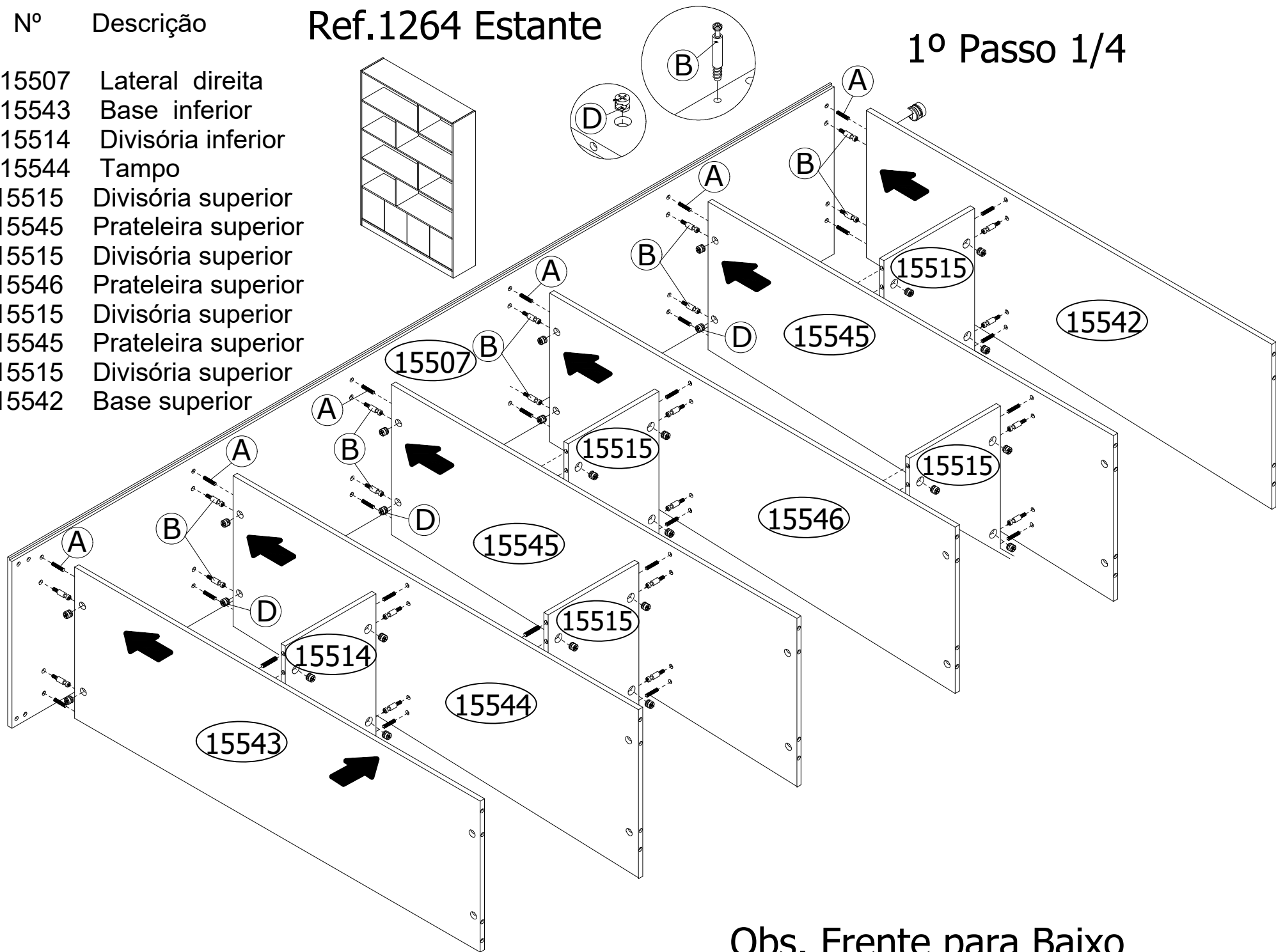

Obs. Frente para Baixo

Ref.1264 Estante

2º Passo 2/4

Ordem	Nº	Descrição
13	15547	Rodapés
14	15548	Rodapé central
15	15508	Lateral esquerda
16	-----	Sapatas

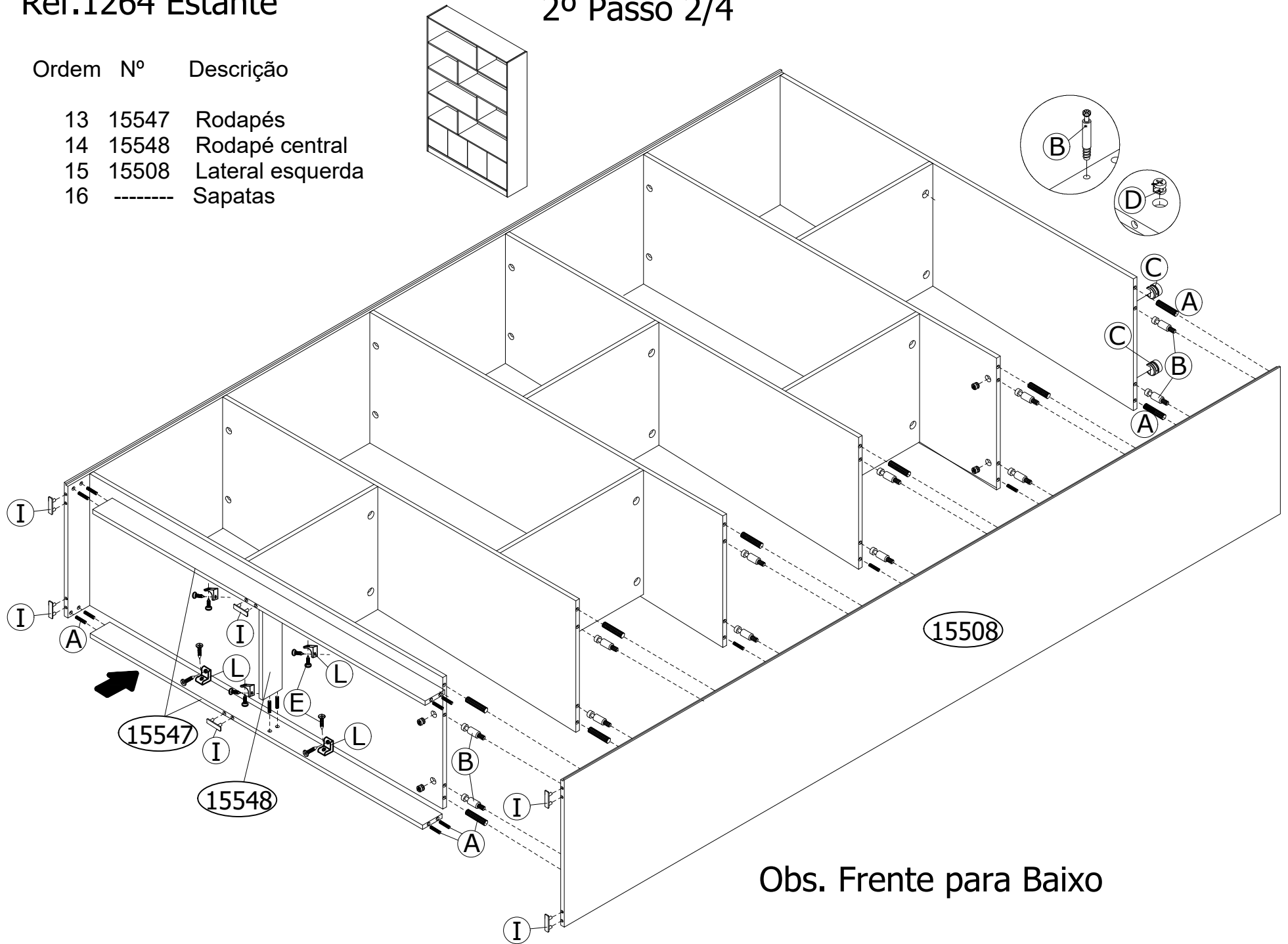

Obs. Frente para Baixo

Ref.1264 Estante

3º Passo 3/4

Ordem	Nº	Descrição
17	15549	Fundo inferior
18	15550	Fundos superiores

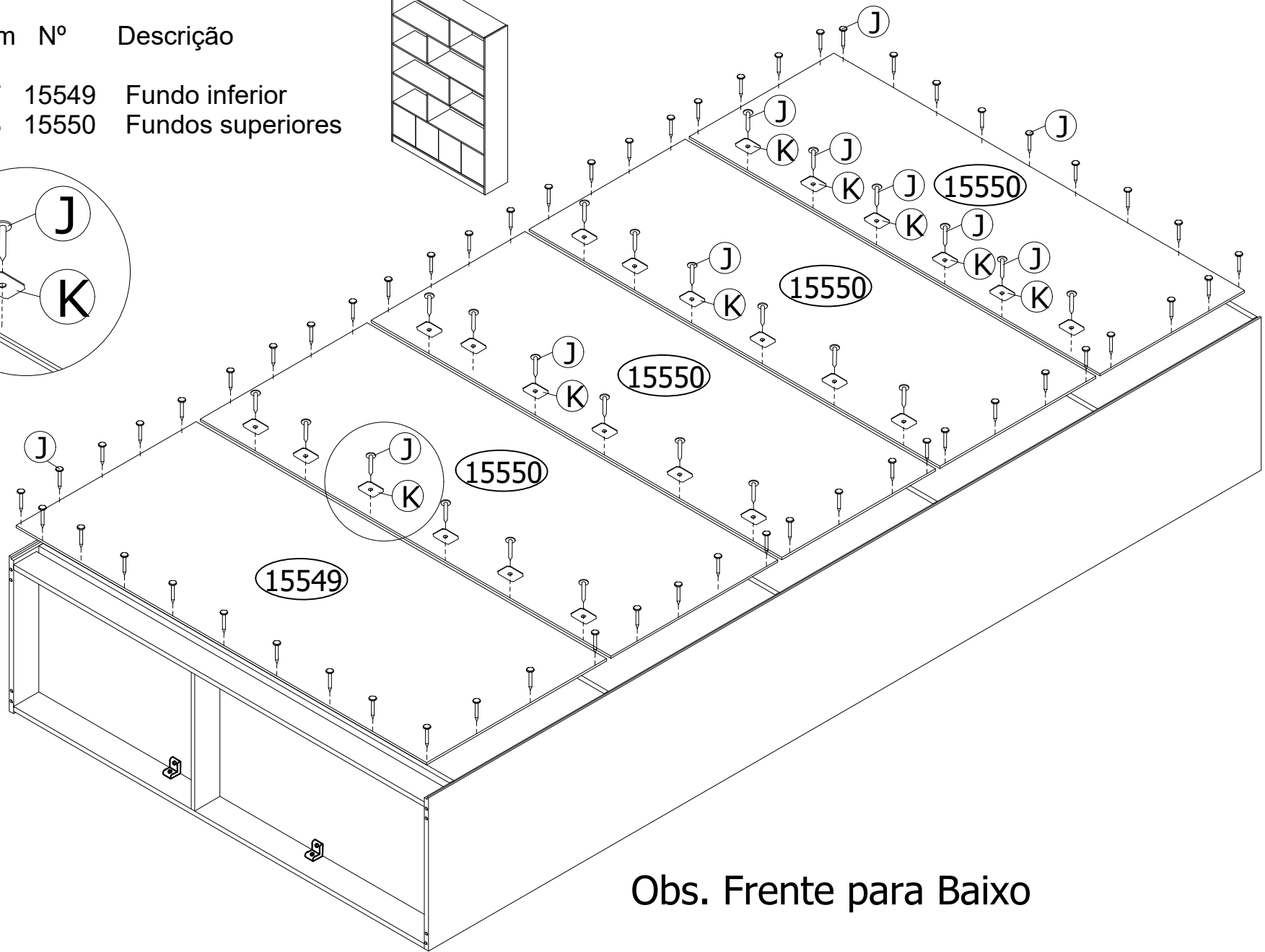
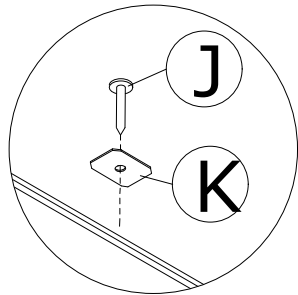
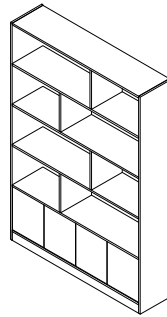

Obs. Frente para Baixo

Ref.1264 Estante

Obs. Colocar as portas tem dois tipos de dobradiças curva e super curva

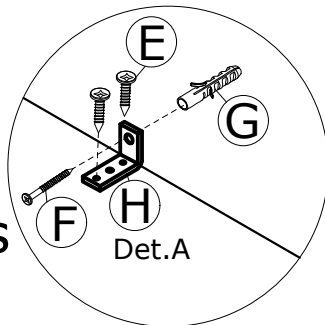

4º Passo 4/4

OBS. Para maior segurança fixar na parede

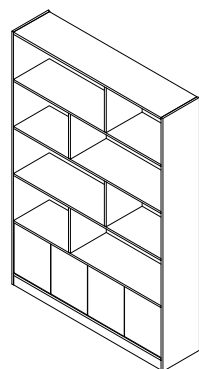
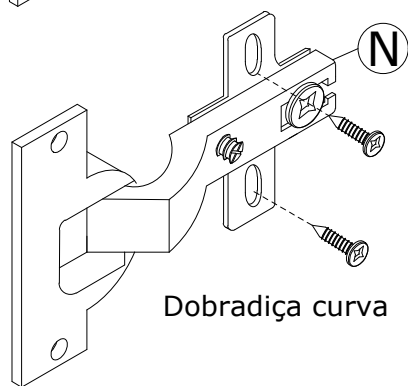
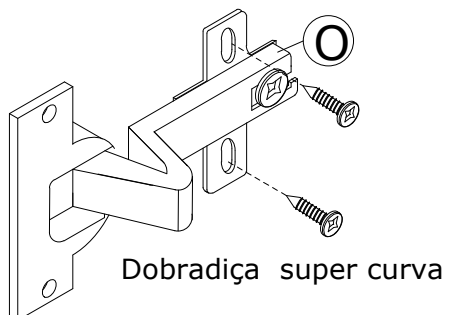
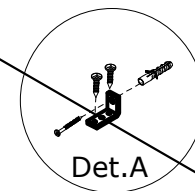

Dobradiça super curva

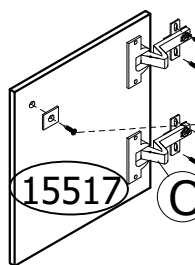

Dobradiça curva nas 2 portas do meio

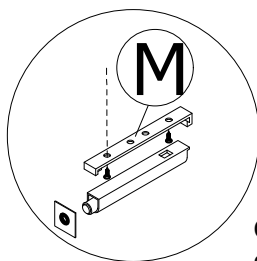

OBS. Fixar os Fechos toques embaixo do tampo na marcação

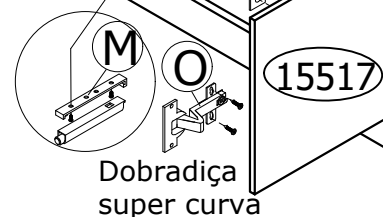

Ordem	Nº	Descrição
19	15517	Portas

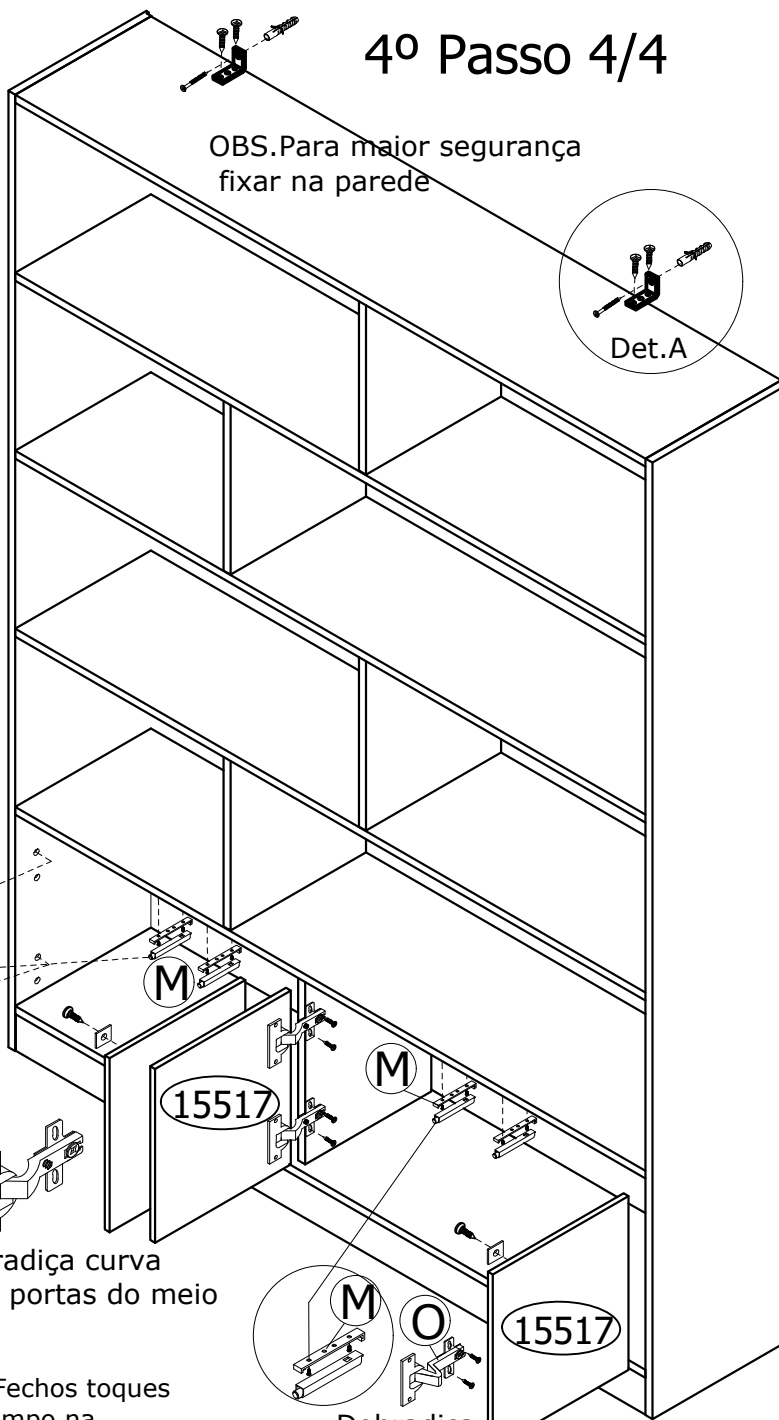

Agora que você já comprou o seu móvel, ele merece ser montado do jeito certo.

Erros de montagem causam mais de **60%** dos danos em móveis.

Por que contratar?

Tranquilidade do **início ao fim** da montagem



PROFISSIONAIS QUALIFICADOS

Especialistas certificados na **MadeiraMadeira Serviços**.



FERRAMENTAS PROFISSIONAIS

que **protegem** seus móveis.



AGENDAMENTO EM 24 HORAS

escolha a data e o turno **ideais para** você.



GARANTIA DE 3 MESES

de cobertura **completa**.

Mais de 1 MILHÃO DE MONTAGENS
★ com avaliação **4.7** ★

Mariana S., São Paulo

"Chegaram no horário e montaram tudo rapidamente. Serviço incrível!"



Carlos R., Belo Horizonte

"Tentei montar sozinho e foi um desastre. Com a **MadeiraMadeira Serviços** ficou perfeito."



Ana P., Rio de Janeiro

"Agendamento ágil e **montagem pontual e perfeita**. Recomendo demais!"



Agende agora pelo QR Code

Madeira**Madeira** Serviços · Atendimento em todo o Brasil



Escaneie o QRCode