

MANUAL DE MONTAGEM

ATENÇÃO:

- 1 - Ler atentamente todo o manual antes de iniciar a montagem do móvel.
- 2 - A montagem deve ser feita em uma superfície plana e limpa.
- 3 - Recomenda-se utilizar a embalagem do móvel para forrar e chão e assim não danificá-los

LIMPEZA E CONSERVAÇÃO:

A limpeza do móvel deve ser feita com utilização de pano umedecido com água, podendo conter uma pequena quantidade de álcool. Não utilize produtos abrasivos.

GARANTIA:

90 dias para defeitos de fabricação.

Quantidade de pessoas
necessárias para montar o
móvel

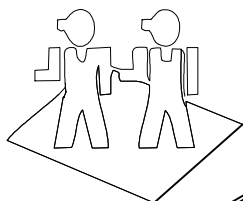

Tempo necessário para a
montagem: 6h





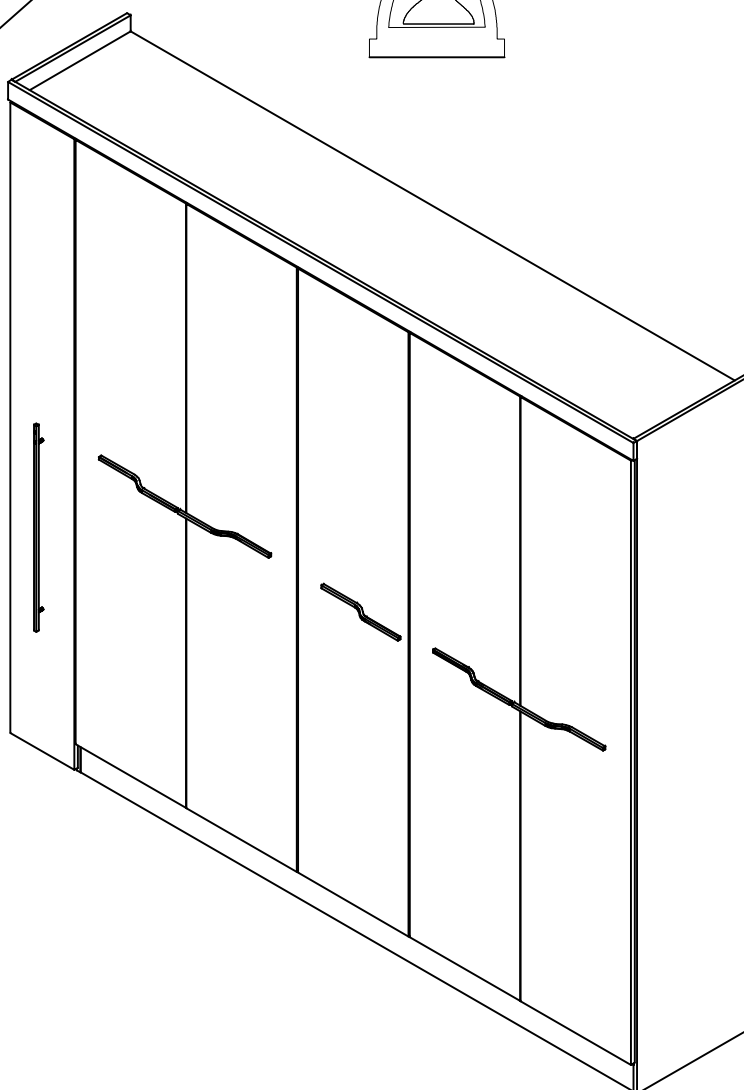
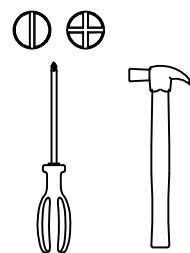





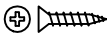

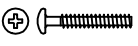
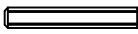

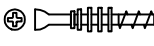
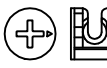

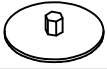

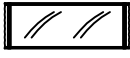









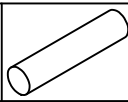

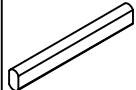

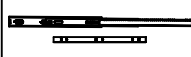
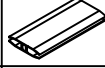
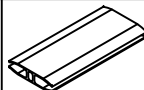

Ferramentas necessárias



Lista de peças						
Código de assistência	Descrição	Quant.	Compr. (mm)	Larg. (mm)	Espes. (mm)	Caixa/ volume
01	Lateral direita	1	2350	480	15	A
02	Lateral esquerda	1	2350	480	15	A
03	Chapéu	1	2570	480	15	D
04	Base maior	1	2299	480	15	D
05	Base menor	1	256	480	15	E
06	Base do meleiro	1	2299	480	15	C
07	Divisória média direita	1	1800	480	15	A
08	Divisória média esquerda	1	1800	480	15	A
09	Divisória maior	1	2276	480	15	C
10	Divisória menor	1	810	480	15	E
11	Tampo de gaveta maior	1	910	480	15	E
12	Tampo de gaveta menor	1	540	480	15	A
13	Prateleiras soltas	3	449	416	15	E
14	Prateleira fixa	1	371	416	15	A
15	Costa do espelho	1	2075	400	15	C
16	Fundo do porta objetos	1	2044	202	15	D
17	Base porta objetos	1	400	202	15	A
18	Chapéu porta objetos	1	400	202	15	E
19	Prateleiras porta objetos	3	384	202	15	E
20	Travessa porta objetos superior	1	450	96	15	C
21	Travessa porta objetos inferior	1	450	96	15	C
22	Travessa menor	1	256	96	15	C
23	Pilastra	2	350	96	15	C
24	Porta menor	1	2270	266	15	C
25	Portas maiores	5	2175	459	15	B
26	Frente de gaveta maior	3	847	160	15	A
27	Frente de gaveta menor	3	486	160	15	C
28	Lateral de gaveta direita	6	400	120	15	E
29	Lateral de gaveta esquerda	6	400	120	15	E
30	Cabeceira de gaveta maior	3	806	120	15	A
31	Cabeceira de gaveta menor	3	445	120	15	A
32	Rodaforro	1	2601	64	15	D
33	Rodapé interno	2	424	96	15	D
34	Rodapé frontal maior	1	2299	96	15	D
35	Rodapé frontal menor	1	256	96	15	D
36	Rodapé traseiro maior	1	2299	96	15	D
37	Rodapé traseiro menor	1	256	96	15	D
38	Afastador de gaveta direito	4	560	80	25	E
39	Afastador de gaveta esquerdo	2	560	80	25	E
40	Costas menores	4	1817	460	3	D
41	Costa maior	1	1817	465	3	D
42	Costa do porta objetos	1	2182	273	3	D
43	Costa do maleiro	1	2315	365	3	D
44	Fundo de gaveta menor	3	458	398	3	E
45	Fundo de gaveta maior	3	819	398	3	E

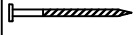
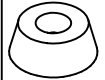

Ferragem			
	Código de assistência	Descrição	Quant.
A	226	 Parafuso chato 4,0x40 bicromatizado	83
B	5256	 Parafuso chato 4,0x20 bicromatizado	18
C	4214	 Parafuso chato 3,5x14 cabeça rebaixada	184
D	10571	 Parafuso maquina M4 X 42 cab. panela	2
E	19730	 Parafuso maquina M4 X 20 cab. panela	10
F	1925	 Cavilha 6x50mm	2
G	1802	 Cavilha 6x30mm	160
H	107	 Pregão 10 x 10	276
I	30945	 Minifix (parafuso)	12
J	30950	 Minifix (tambor)	12
K	2347	 Tampa para minifix Branco	12
K	14855	 Tampa para minifix Carvalle	12
L	1423	 Fixador de costa	80
M	58	 Etiqueta marca "Kappesberg"	1
N	41	 Cola branca em bisnaga (10g)	1
O	40530	 Espelho 100,0 x 36,4 3mm	1
P	47	 Dobradiça curva 35	15
Q	47	 Calço para dobradiça	15
R	47	 Parafuso panela 4,0x14 para dobradiça	60
S	85	 "L" de metal	25
T	39904	 Puxador 10 x10 Rose 740mm	1
U	39944	 Ponteira 10 x 10 Rose (par)	6

V	39943	 Afastador de nylon 20mm Rose	1
W	39903	 Puxador de metal 10x10 Rose 348mm	5
X	40419	 Rodizio RB30 Rolete	2
Y	40862	 Rolicho oblongo 15x27 metal 90,2	2
Z	41921	 Suporte para cabideiro oblongo metal	4
AA	18458	 Suporte triangular preto	18
AB	38305	 Trilho telescópico life (35) 400mm	6
AC	41049	 Trilho telescópico life (45) 450mm	1
AD	10585	 Perfil "H" 1810mm Branco	2
AD	36205	 Perfil "H" 1810mm Carvalle	2
AE	118	 Suporte para prateleira	12
AF	40483	 Tapa furo adesivo Branco fosco	83
AF	40736	 Tapa furo adesivo Nogal	83
AG	899	 Cantoneira de metal	11
AH	414	 Parafuso panela 4,0x35 bicromatizado	18
AI	41358	 Haste 4,75x400mm Moka	3
AI	40841	 Haste 4,75x400mm Branco Fosco	3
AJ	149	 Pregão 13 x 15	10
AK	1901	 Sapata deslizadora preta	10
AL	1828	 Parafuso panela 3,5x14 bicromatizado	4
AM	61	 Fecho rolete	2

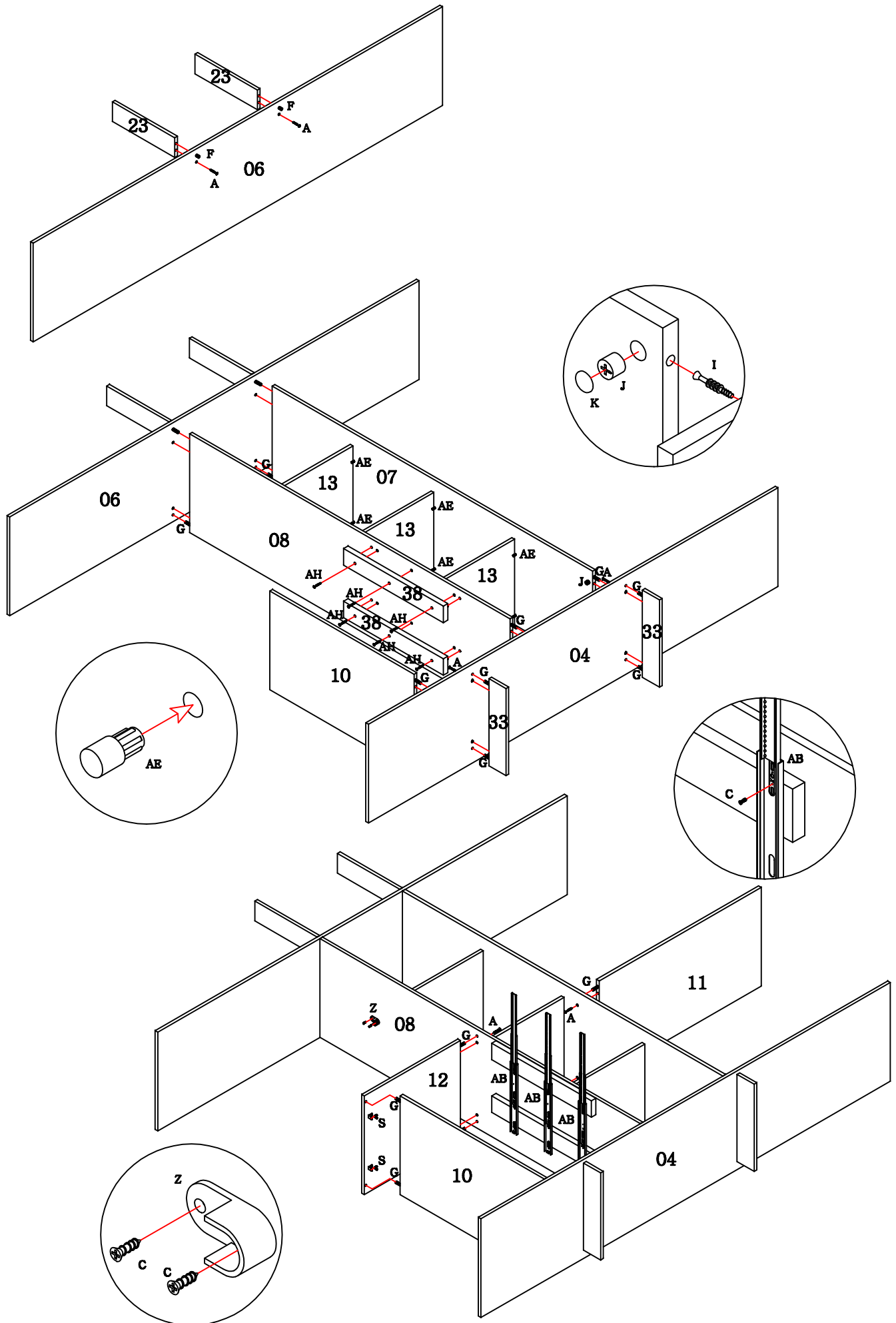

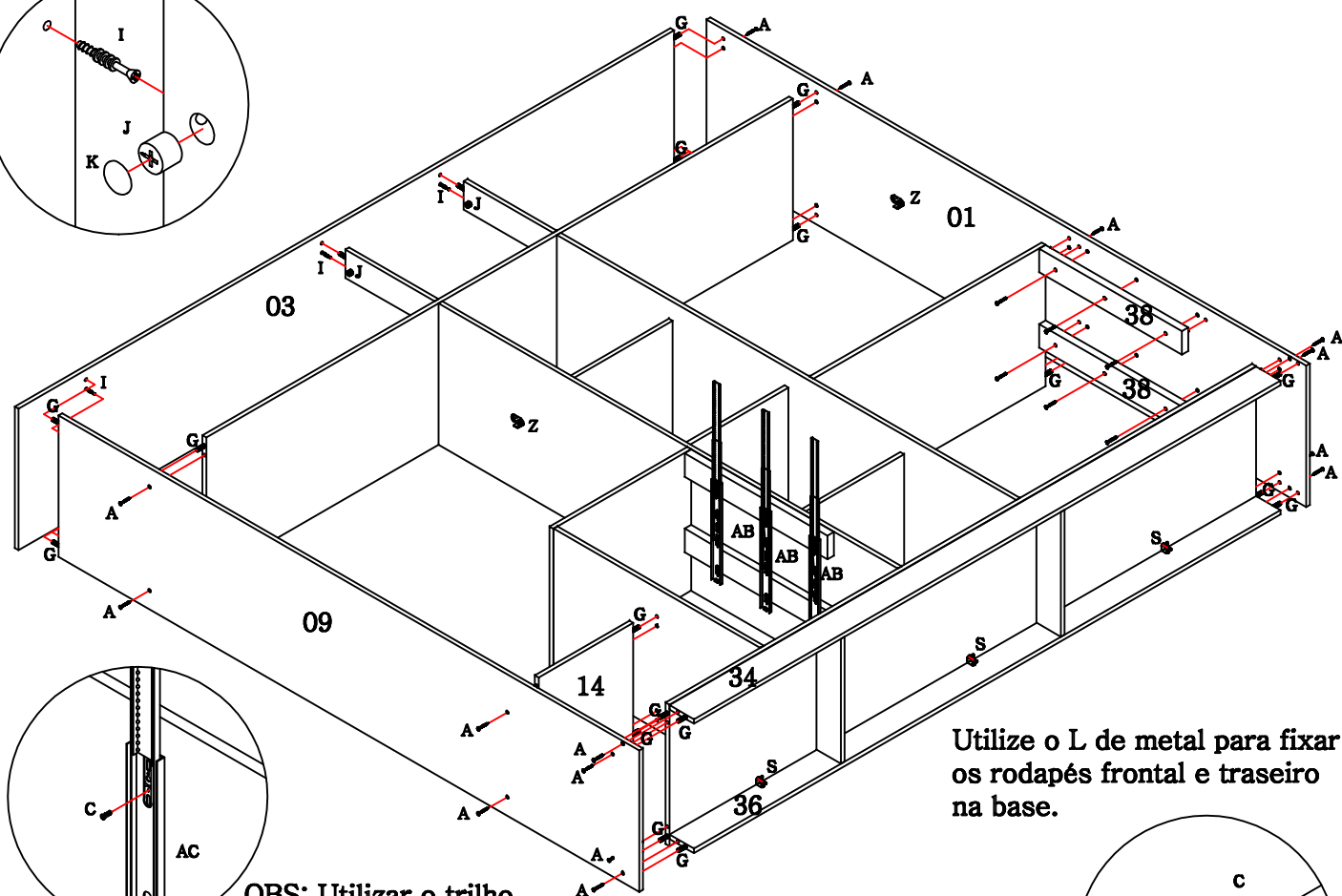
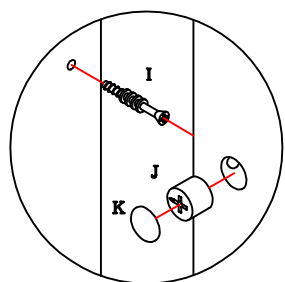

Utilize o L de metal para fixar os rodapés frontal e traseiro na base.

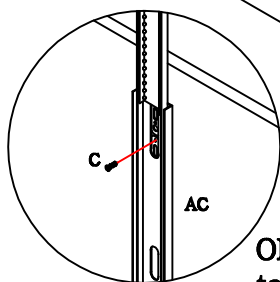

OBS: Utilizar o trilho telescópico "AC" para a porta deslizante lateral.

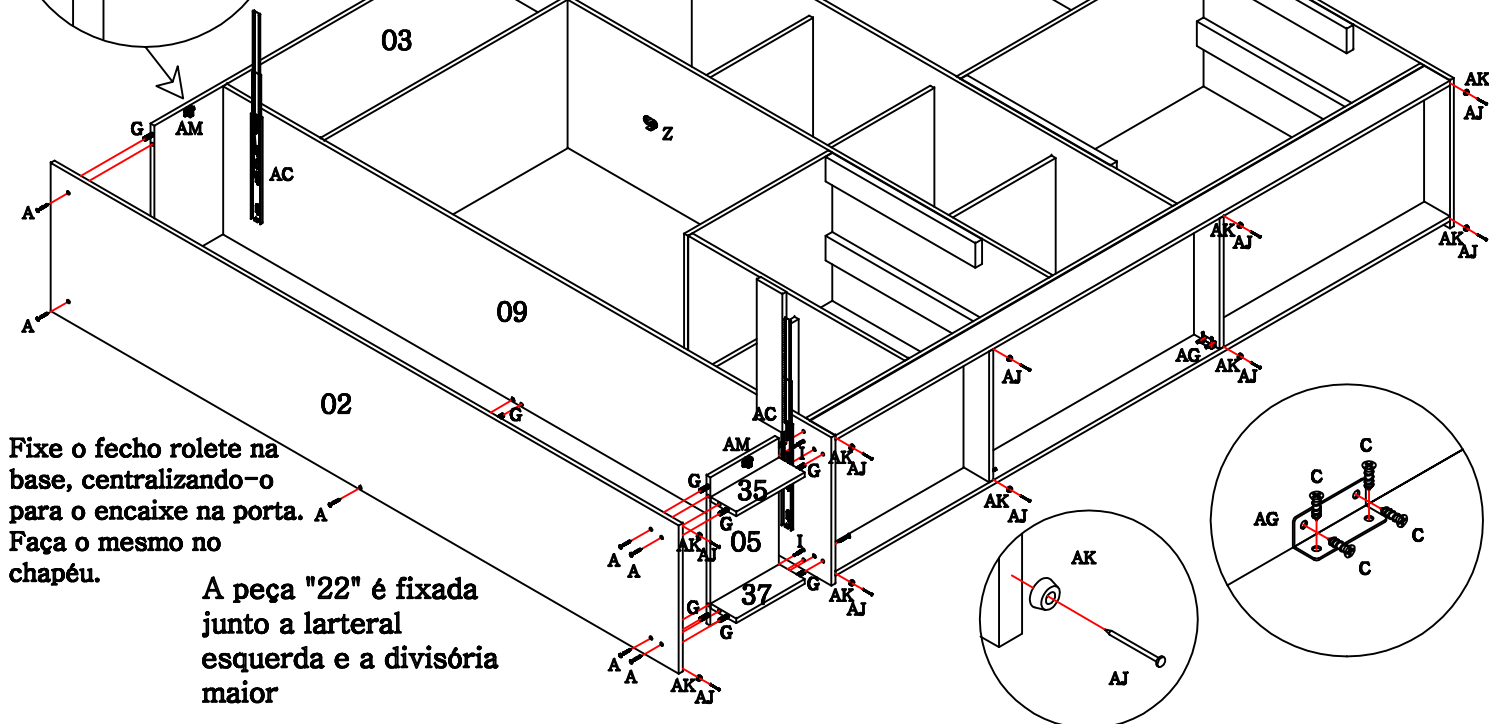
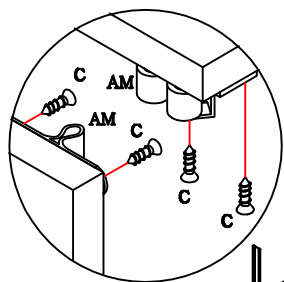
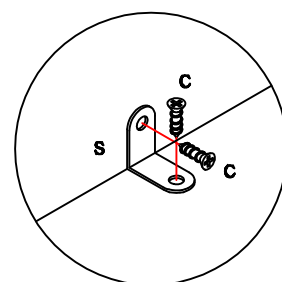

Fixe o fecho rolete na base, centralizando-o para o encaixe na porta. A
Faça o mesmo no chapéu.

A peça "22" é fixada junto a lateral esquerda e a divisória maior

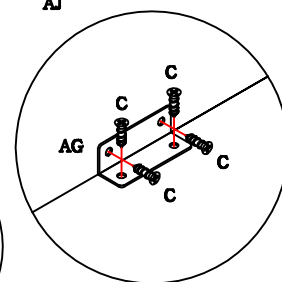
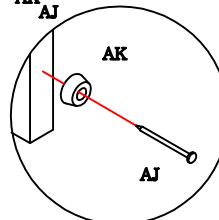

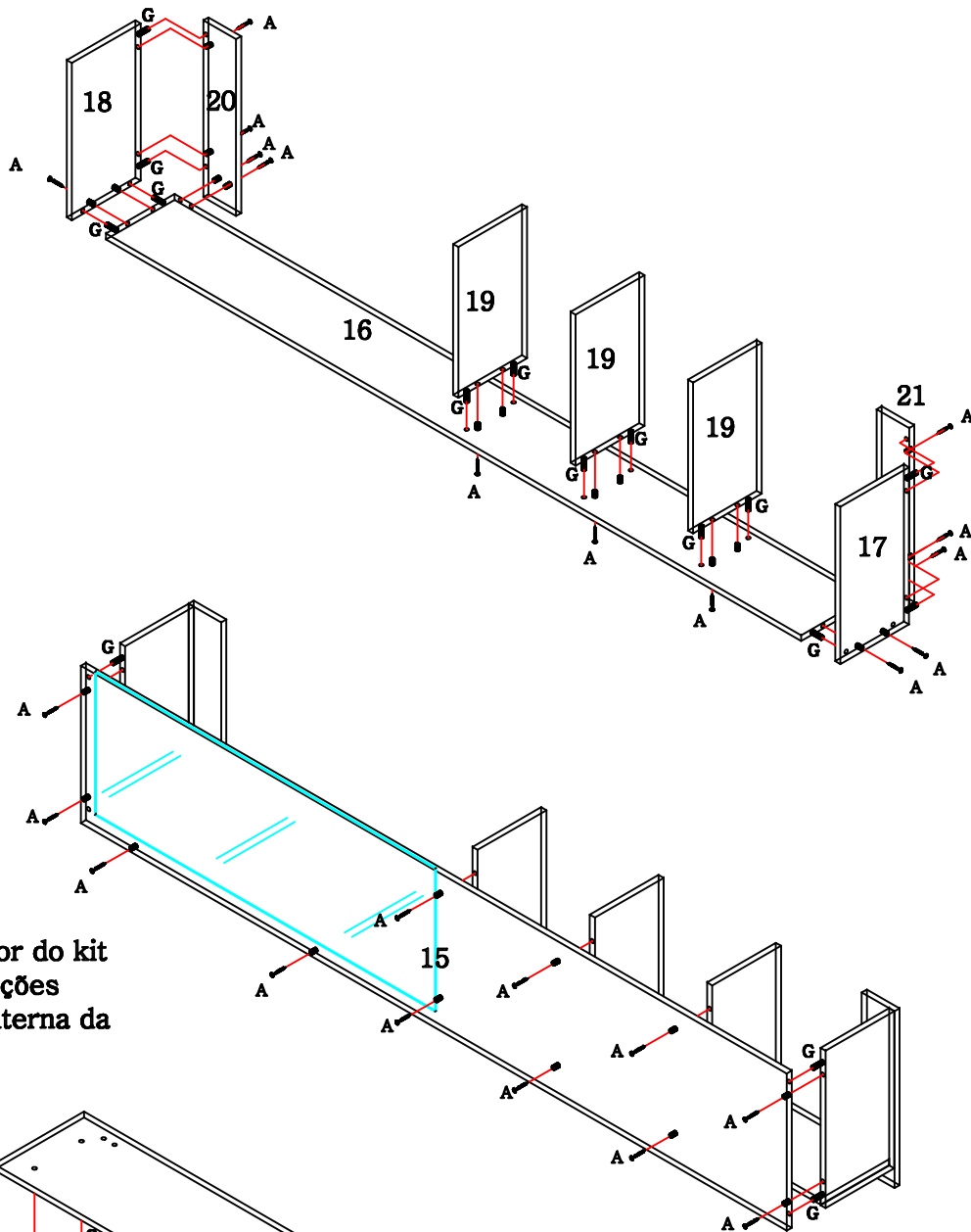

Fixe a peça menor do kit rolete nas marcações feitas na parte interna da porta de puxar.

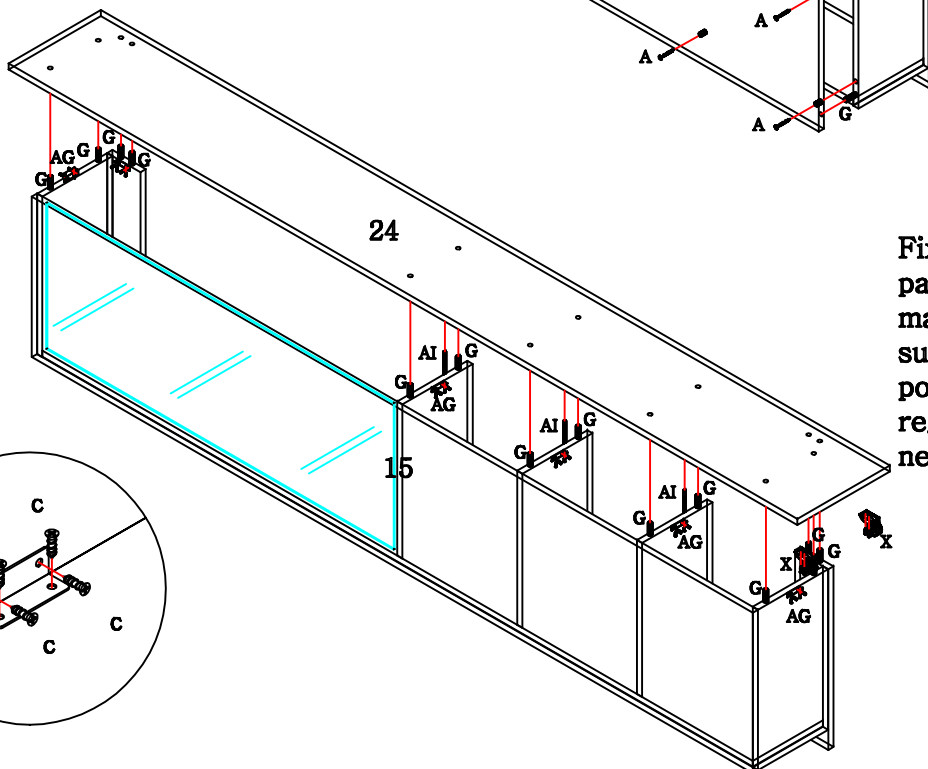

Fixe o rodízio "X" com o parafuso "AL" na marcação utilizando o furo superior do rodízio, podendo ser feita uma regulagem conforme a necessidade.

Fixe o puxador "T" com o parafuso "D", utilizando o afastador "V" no puxador.

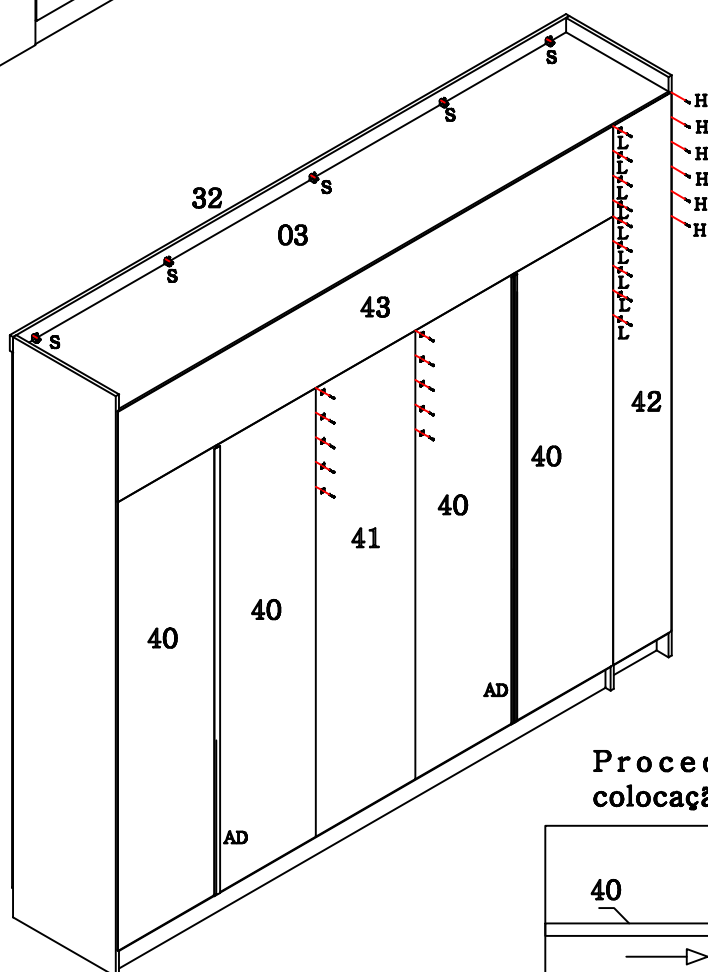
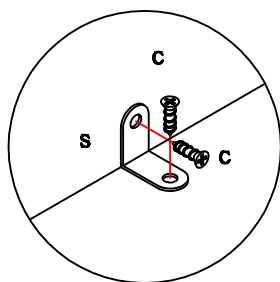
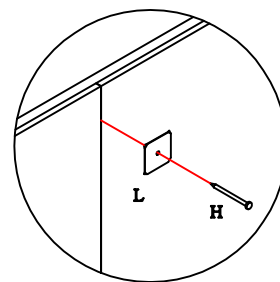
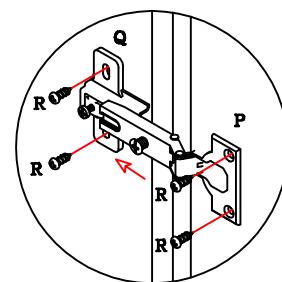
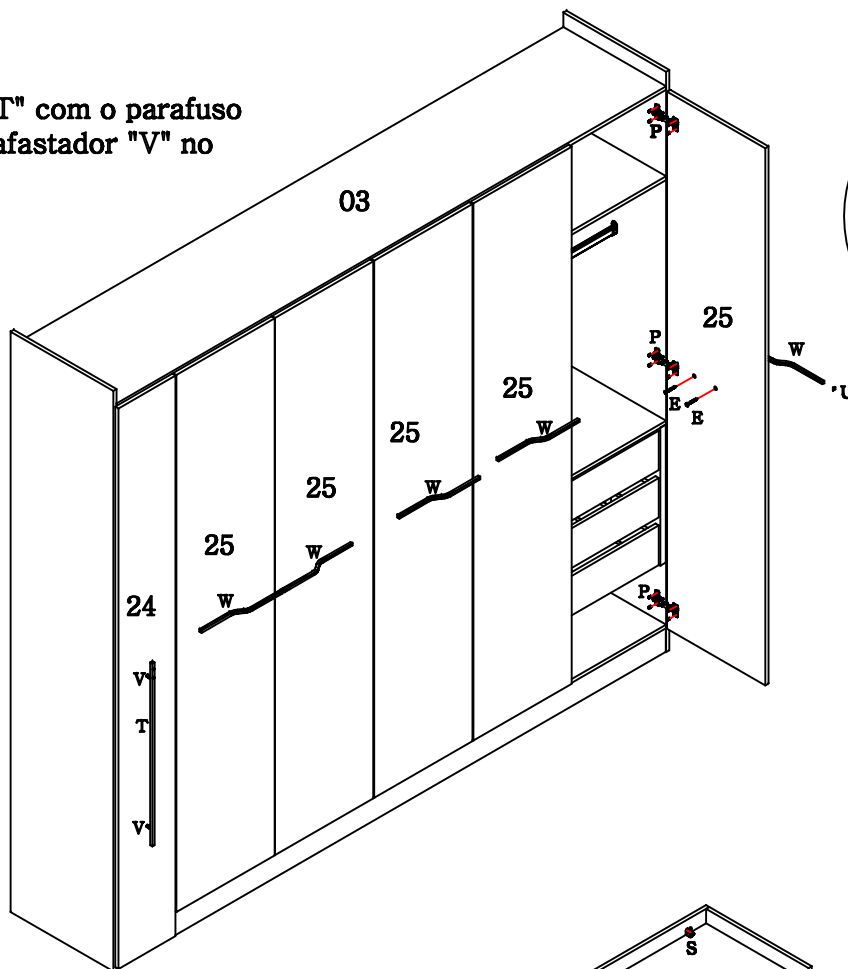

Procedimento de colocação do perfil H.

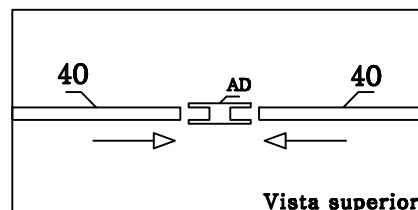

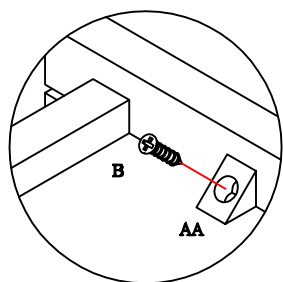
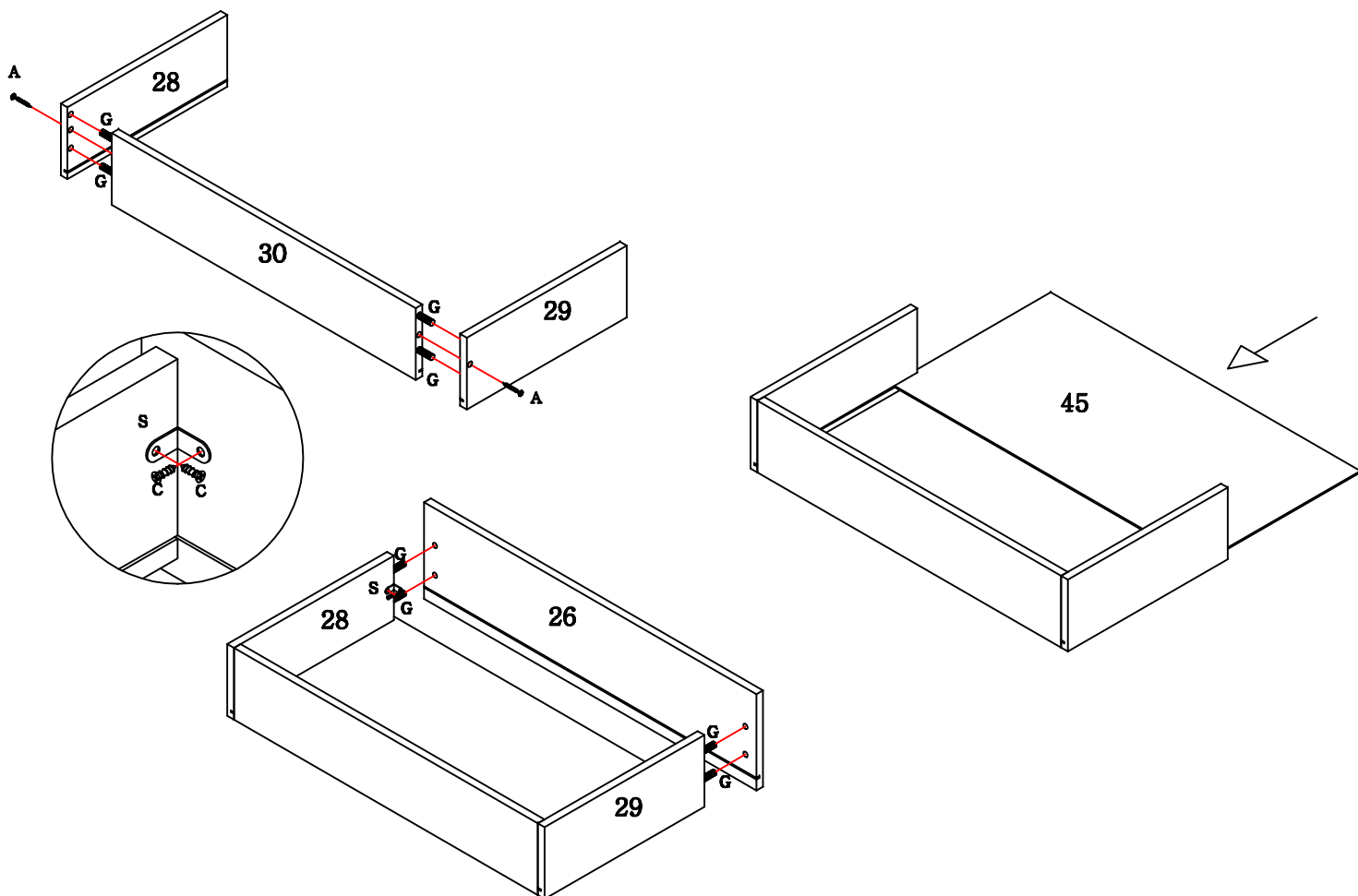

Nas gavetas maiores, utilize 4 suportes triangulares, 2 na parte frontal e 2 na parte traseira da gaveta.

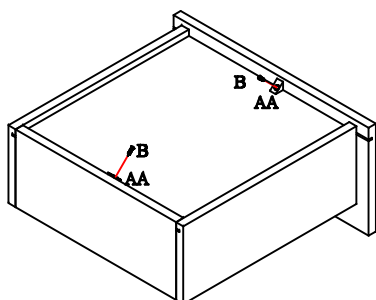
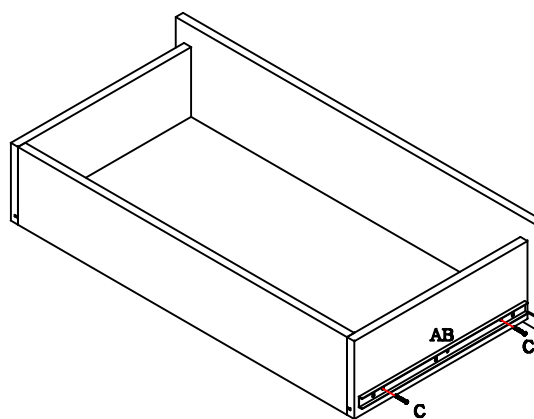

Detalhe da gaveta menor.

