

MANUAL DE MONTAGEM

ATENÇÃO:

- 1 - Ler atentamente todo o manual antes de iniciar a montagem do móvel.
- 2 - A montagem deve ser feita em uma superfície plana e limpa.
- 3 - Recomenda-se utilizar a embalagem do móvel para forrar e chão e assim não danificá-los

LIMPEZA E CONSERVAÇÃO:

A limpeza do móvel deve ser feita com utilização de pano umedecido com água, podendo conter uma pequena quantidade de álcool. Não utilize produtos abrasivos.

GARANTIA:

90 dias para defeitos de fabricação.

Quantidade de pessoas
necessárias para montar o
móvel

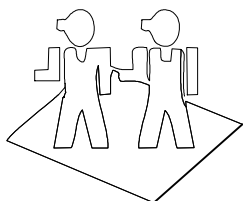







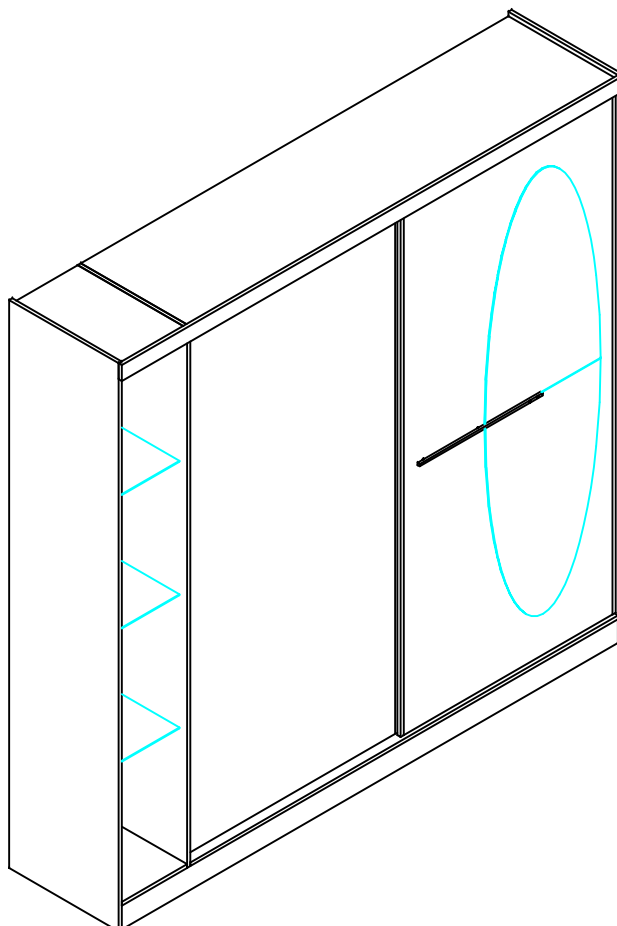
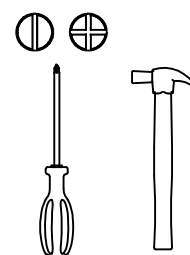



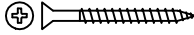



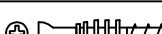



Tempo necessário para a
montagem: 4h



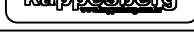
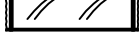
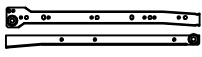



















Ferramentas necessárias

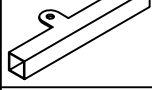

Lista de peças						
Código de assistência	Descrição	Quant.	Compr. (mm)	Larg. (mm)	Espes. (mm)	Caixa/ volume
01	Lateral direita	1	2300	512	15	A
02	Lateral esquerda	1	2300	512	15	A
03	Chapéu maior	1	2000	512	15	C
04	Chapéu menor	1	305	512	15	A
05	Base maior	1	2000	512	15	C
06	Base menor	1	305	512	15	A
07	Base do maleiro	1	2000	448	15	C
08	Divisória maior	1	2186	512	15	A
09	Divisória menor	1	1790	448	15	C
10	Tampo de gaveta	1	920	448	15	D
11	Prateleiras menores	2	920	416	15	D
12	Prateleira maior	1	1065	416	15	C
13	Pilastra	1	350	96	15	A
14	Porta direita	1	2142	977	15	B
15	Porta esquerda	1	2142	977	15	B
16	Frente de gaveta	3	904	160	15	D
17	Lateral de gaveta	6	400	120	15	A
18	Cabeceira de gaveta	3	865	120	15	D
19	Rodaforro	1	2351	64	15	A
20	Rodapé frontal	1	2320	96	15	A
21	Rodapé traseiro	1	2320	96	15	A
22	Rodapé interno	1	456	96	15	D
23	Costa larga	1	1808	938	3	B
24	Costa estreita	2	1808	538	3	B
25	Costa alta	1	2173	322	3	A
26	Costa do maleiro	1	2019	365	3	A
27	Fundo de gaveta	3	878	398	3	C

Ferragem			
	Código de assistência	Descrição	Quant.
A	226	 Parafuso chato 4,0x40 bicromatizado	54
B	5256	 Parafuso chato 4,0x20 bicromatizado	12
C	4214	 Parafuso chato 3,5x14 cabeça rebaixada	96
D	1828	 Parafuso panela 3,5x14 bicromatizado	8
E	30945	 Minifix (parafuso)	7
F	30950	 Minifix (tambor)	7
G	10571	 Parafuso maquina M4 X 42 cab. panela	2
H	1925	 Cavilha 6x50mm	7
I	1802	 Cavilha 6x30mm	58
J	149	 Prego 13 x 15	9
K	107	 Prego 10 x 10	189
L	899	 Cantoneira de metal	6
M	40534	 Batente de silicone	8
N	58	 Etiqueta marca "Kappesberg"	1
O	41	 Cola branca em bisnaga (10g)	1
P	5288	 Corrediça 400mm (de metal) branca	3
Q	43168	 Espelho 900 x 540 (3mm) canto arredondado	2
R	18458	 Suporte triangular preto	12
S	1901	 Sapata deslizador preta	9
T	1423	 Fixador de costa	60
U	43170	 Puxador 10 x10 560mm rose com brilhantes	1

V	39944	 Ponteira 10 x 10 rose (par)	1
W	39943	 Afastador de nylon 20mm rose (par)	1
X	85	 "L" de metal	11
Y	43328	 Puxador de chapa Rose	1
Z	35960	 Roliço oblongo 115x27 metal 105,7	1
AA	4860	 Rolete com regulagem	2
AB	4860	 Rolete sem regulagem	2
AC	4860	 Guia metélico	4
AD	40484	 Suporte para tampo de vidro rose	12
AE	41921	 Suporte para cabideiro oblongo metal	2
AF	4863	 Trilho de alumínio 1998mm	2
AG	8018	 Trilho de plástico cor alumínio 1999mm	2
AH	43169	 Vidro incolor 48,0 x 29,7 x 4mm	3
AI	43213	 Barra de metal branco fosto para porta de correr 214,2cm	4
AI	43171	 Barra de metal moka para porta de correr 214,2cm	4
AJ	6410	 Perfil "H" 1790mm branco	1
AJ	12096	 Perfil "H" 1790mm carvalle	1
AK	2347	 Tampa para minifix Branco	7
AK	14855	 Tampa para minifix Carvalle	7
AL	40483	 Tapa furo adesivo 13mm Branco Fosco	54
AL	40736	 Tapa furo adesivo 13mm Nogal	54



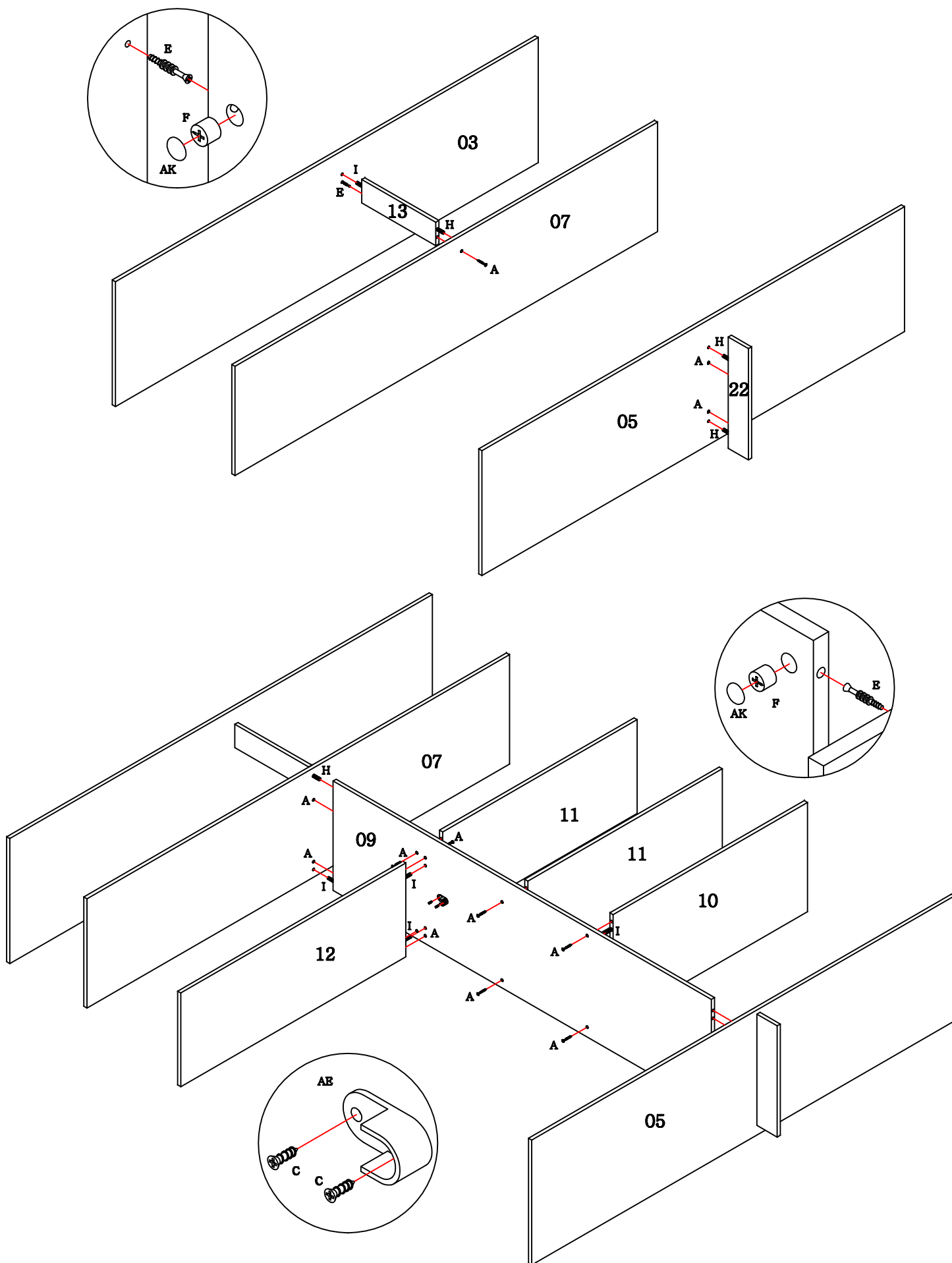

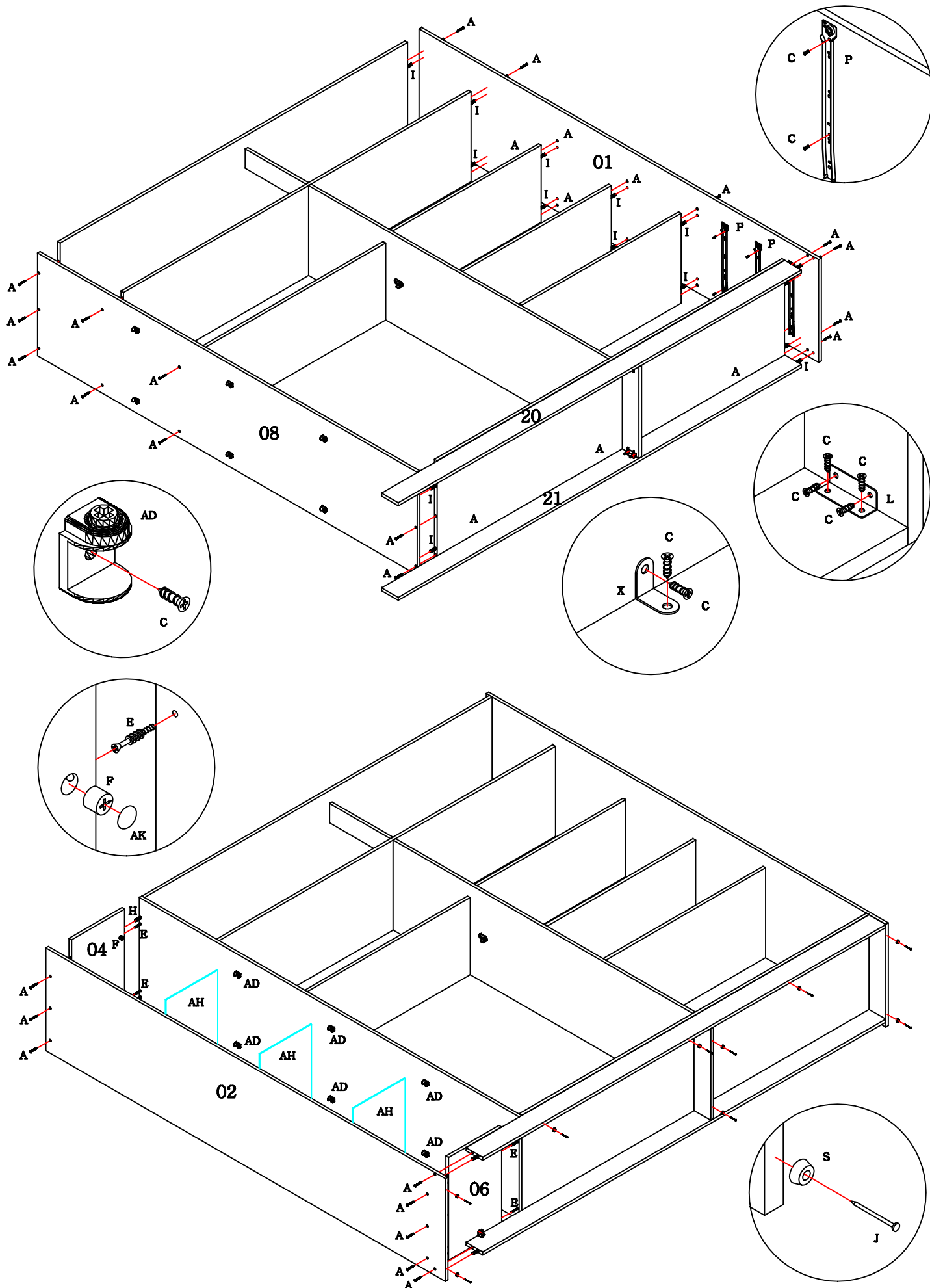

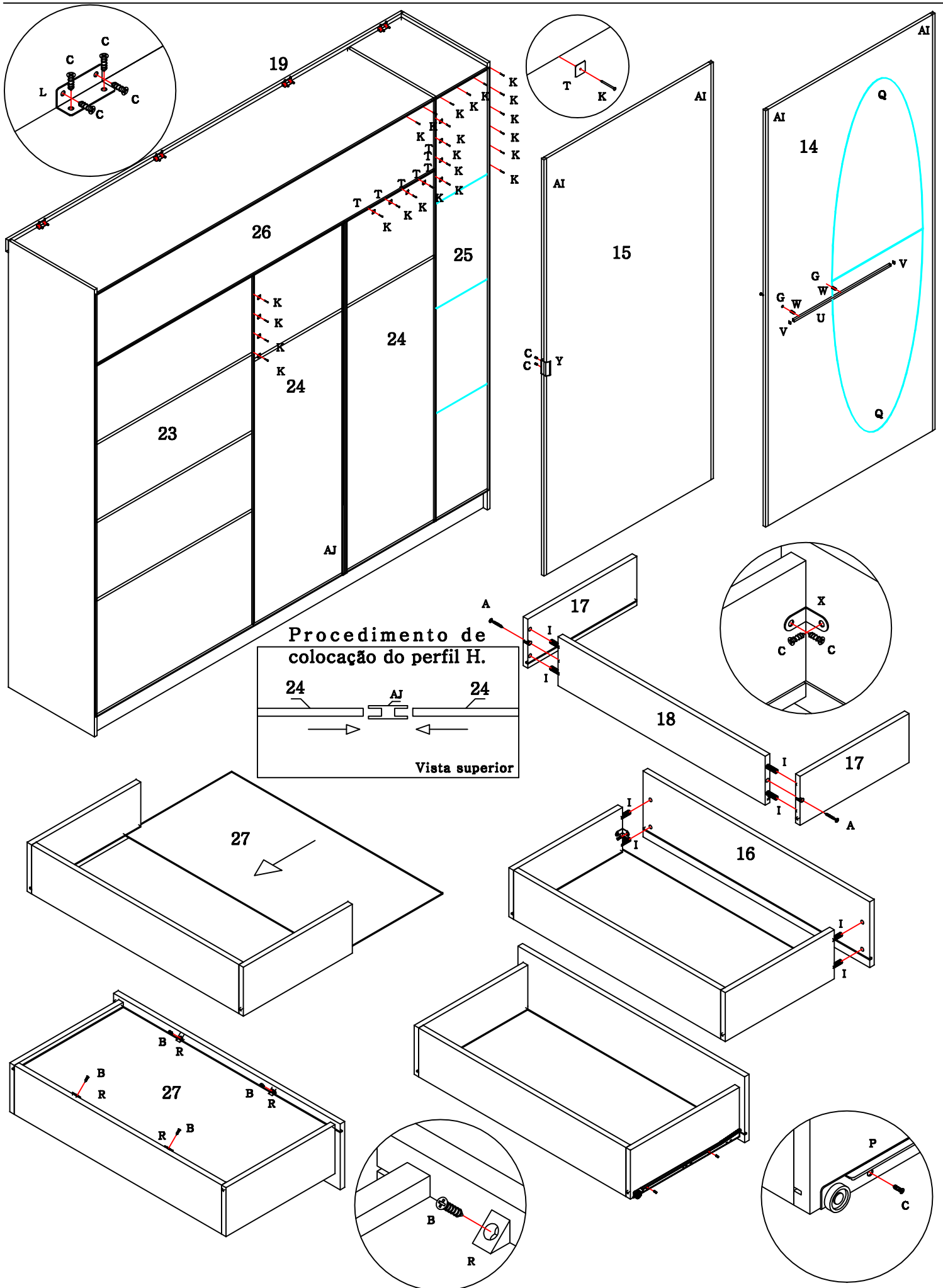

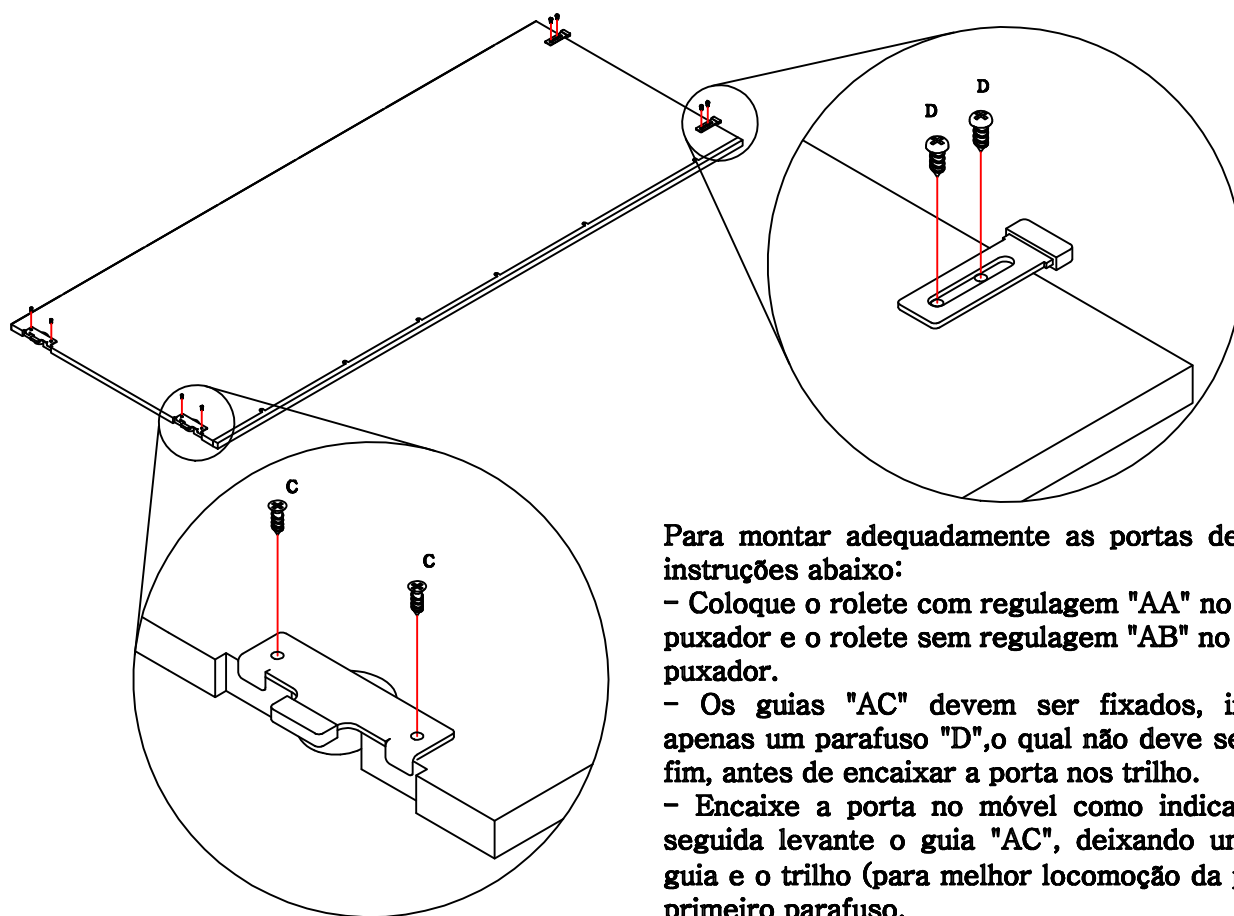

Para montar adequadamente as portas de correr, siga as instruções abaixo:

- Coloque o rolete com regulagem "AA" no lado do puxador e o rolete sem regulagem "AB" no lado oposto ao puxador.
- Os guias "AC" devem ser fixados, inicialmente com apenas um parafuso "D", o qual não deve ser apertado até o fim, antes de encaixar a porta nos trilhos.
- Encaixe a porta no móvel como indicado abaixo e em seguida levante o guia "AC", deixando uma folga entre o guia e o trilho (para melhor locomoção da porta) e aperte o primeiro parafuso.
- Em seguida coloque o segundo parafuso em cada guia.

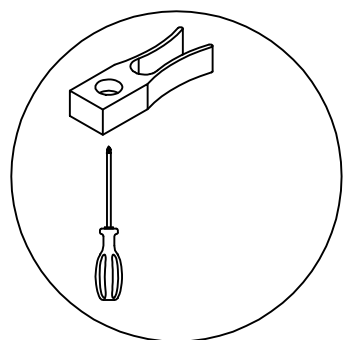

Obs: Após montar as portas devem ser regulados os freios dos trilhos, que já estão pré fixados no trilho.

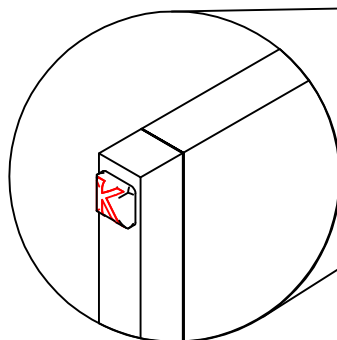

Obs: não dispense o uso da Batente de Silicone "M", pois a mesma serve para suavizar eventuais impactos.

