

Painel Box Londres

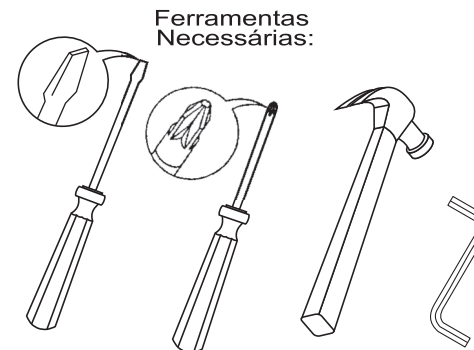

ESQUEMA DE MONTAGEM

09/03/2016

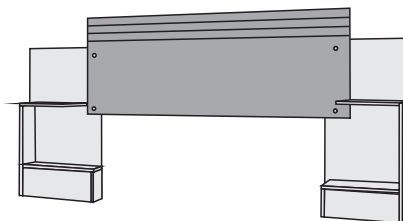
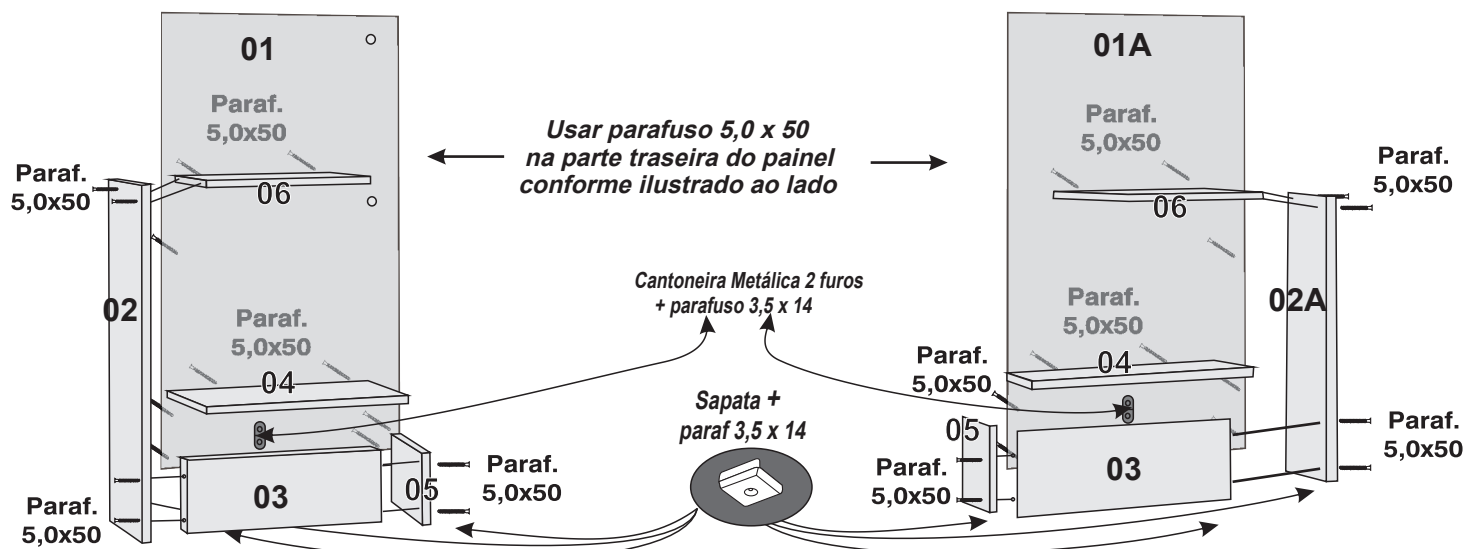



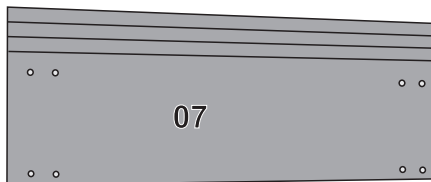



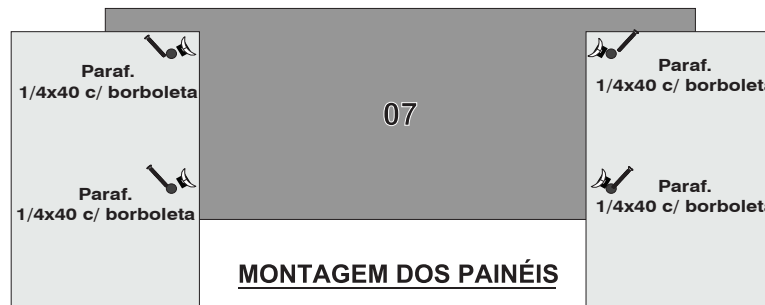

Painel Central Frisado



Painel para colchões box de 1380 mm e 1580 mm

Parafusar pela frente e rosquear pela parte traseira



	Parafuso 3,5 x 14	12 UN
	Parafuso 1/4 x 40 c/ Borboleta	04 UN
	Cantoneira Metálica 02 furos	02 UN
	Sapata	08 UN
	Parafuso 5,0 x 50 cabeça chata	32 UN
	Tampa Cabeça Parafuso 13mm	04 UN
	Tampa Cabeça Parafuso 10 mm	16 UN

Painel Box Londres
código: 4264

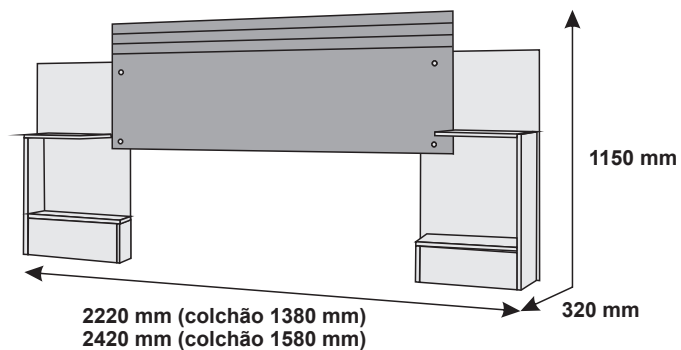

CÓDIGO	Nº	DESCRIÇÃO	QT.	CÓD. MALBEC	CÓD. IMBUIA MEL	CÓD. ROVERE		
4425	01	PAINEL TRASEIRO ESQUERDO	01	4425	4425	4425		
4426	01A	PAINEL TRASEIRO DIREITO	01	4426	4426	4426		
4427	02	LATERAL ESQUERDO	01	4427	4427	4427		
4428	02A	LATERAL DIREITA	01	4428	4428	4428		
4431	03	RODAPE FRONTAL	02	4431	4431	4431		
4430	04	BASE CASAL	02	4430	4430	4430		
4432	05	RODAPÉ LATERAL	02	4432	4432	4432		
4429	06	PRATELEIRA LATERAL	02	4429	4429	4429		
4424	07	PAINEL CENTRAL	01	4424	4424	4424		
-----	08	KIT FERRAGEM	01	3770	3771	3772		