

Mesa Paris

Itália - Itália s/ vidro

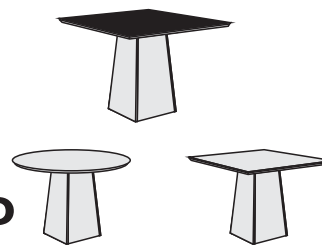

ESQUEMA DE MONTAGEM

11/10/2016

1º Passo

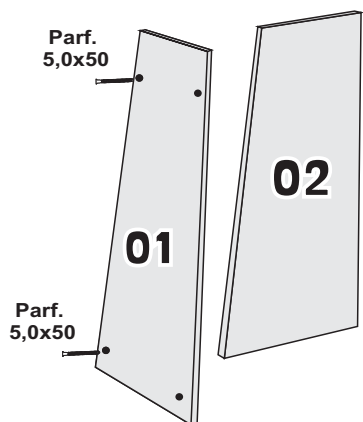

Montagem da Base



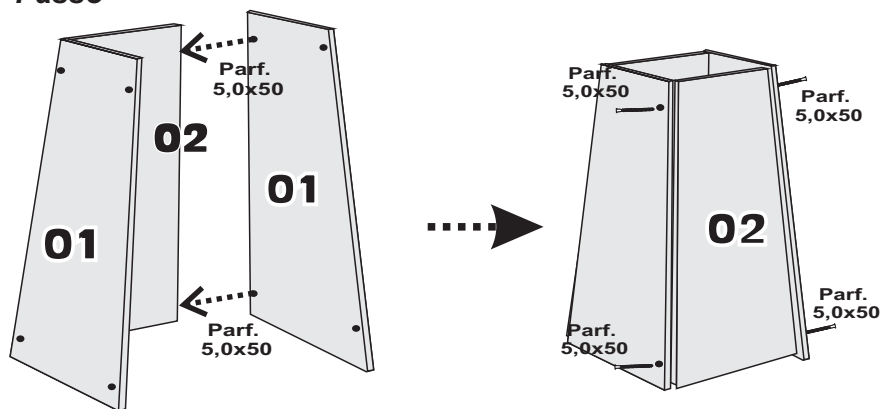

2º Passo

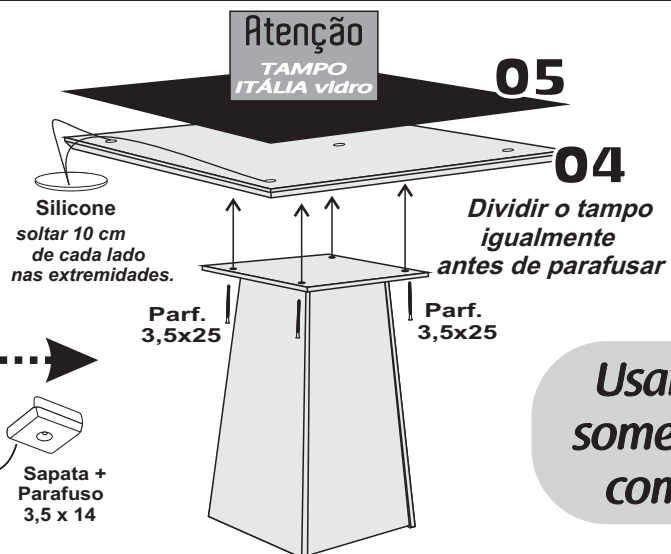
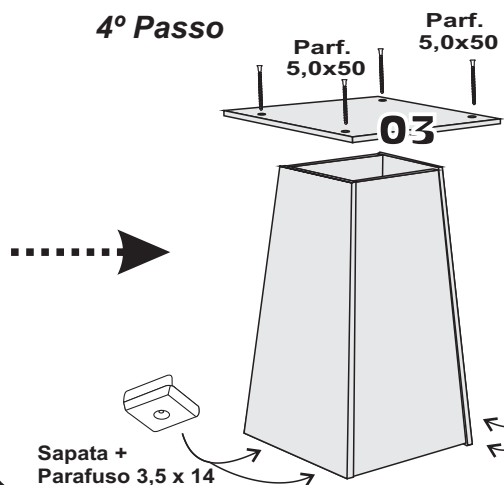

4º Passo



Usar silicone somente na Mesa com o vidro.

	Parafuso 5,0 x 50	08 UN
	Tampa Cabeça de Parafuso 10 mm	08 UN
	Sapata 01 Aba	04 UN
	Parafuso 3,5 x 14	04 UN
	Parafuso 3,5 x 25	04 UN

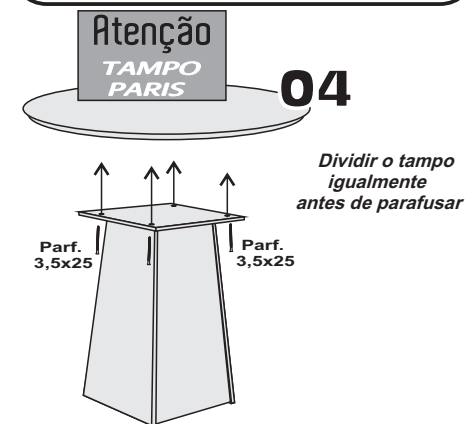

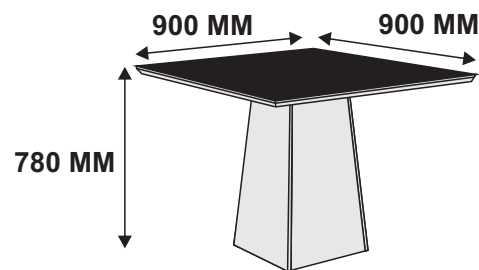

Mesa Itália

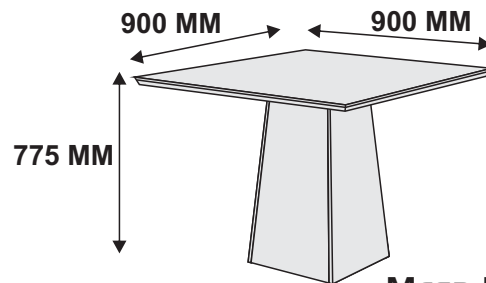

Mesa Itália s/ Vidro

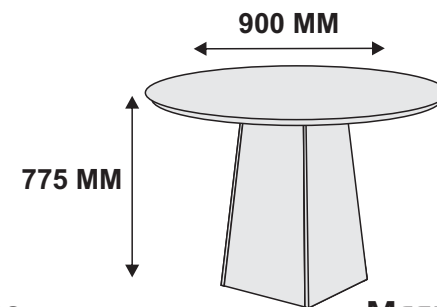

Mesa Paris

Mesa Itália

cód - 6238

CÓDIGO	Nº	DESCRIÇÃO	QT	CÓD. MALBEC	CÓD. IMBUIA MEL			
6240	01	LATERAL FILETADA	02	6240	6240			
6241	02	LATERAL SEM FILETE	02	6241	6241			
6244	03	SUPORTE DO TAMPO	01	6244	6244			
6506	04	TAMPO MONTADO	01	6506	6506			
-----	05	VIDRO	01	-----	-----			
-----	06	KIT FERRAGEM	01	-----	-----			

Mesa Paris - tampo redondo

cód - 6510

CÓDIGO	Nº	DESCRIÇÃO	QT	CÓD. MALBEC	CÓD. IMBUIA MEL	CÓD. YPÉ RÚSTICO		
6240	01	LATERAL FILETADA	02	6240	6240	6240		
6241	02	LATERAL SEM FILETE	02	6241	6241	6241		
6244	03	SUPORTE DO TAMPO	01	6244	6244	6244		
6512	04	TAMPO	01	6512	6512	6512		
-----	05	KIT FERRAGEM	01	-----	-----	-----		