



JCM
movelaria

Painel Sabiá Sabiá Panel Panel Sabiá



Indicamos que a montagem dos produtos seja realizada com parafusadeira eléctrica e por um montador profissional.

We recommend that the product assembly be performed with a cordless screwdriver and by a professional furniture assembler.
Se recomienda que el montaje de los productos sea realizado con un destornillador eléctrico y por un montador de muebles profesional.

















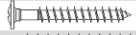

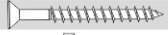
AVISO: Não nos comprometemos pelo mal-uso, montagem e fixação do produto à parede. Portanto, não somos responsáveis por danos e quedas do produto, eletrônicos e pertences neles contidos. É importante o uso de brocas e ferramentas compatíveis na montagem.
ATTENTION: We are not responsible for misuse, assembly and wall fixation. Therefore, we are not responsible for damages and falls caused to the product, electronics and belongings therein. It is important to use suitable drills and tools for the assembly.
ATENCIÓN: No nos responsabilizamos del mal uso, montaje y fijación del producto a la pared. Por lo tanto, no somos responsables de daños y caídas del producto, electrónicos y objetos que contiene. Es importante el uso de taladros y herramientas compatibles con el montaje.

Dica: Para evitar possíveis avarias, use a embalagem do produto como apoio durante a montagem.

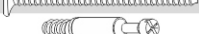
Tip: To avoid damages, use the product packaging as base during the assembly.

Pista: Para evitar daños, use el envase del producto como apoyo durante el montaje.

RELAÇÃO DE FERRAGENS | HARDWARE LIST | LISTADO DE HERRAJES

ARRUELA LISA 1/4	(A)	1/4 FLAT WASHER	(A)	ARANDELA PLANA 1/4	(A)		02
ARRUELA M4 3/16	(B)	3/16 WASHER	(B)	ARANDELA 3/16	(B)		04
BUCHA GESSO 10mm	(C)	10mm PLASTERBOARD ANCHOR	(C)	TACO YESO 10mm	(C)		06
CAVILHA 6x30	(D)	6x30 DOWEL	(D)	CLAVIJA 6x30	(D)		15
CHAPA UNIAO 4 FUROS	(E)	4-HOLE CONECTION PLATE	(E)	PLACA DE UNIÓN 4 AGUJEROS	(E)		03
PARAFUSO CHP CHA BC 3,5x14	(F)	3.5x14 SCREW	(F)	TORNILLO 3.5x14	(F)		12
PARAFUSO CHP CHA BC 3,5x16	(G)	3.5x16 SCREW	(G)	TORNILLO 3.5x16	(G)		08
PARAFUSO CHP CHA BC 4x25	(H)	4x25 SCREW	(H)	TORNILLO 4x25	(H)		12
PARAFUSO CHP FLA BC 5x40	(I)	5x40 SCREW	(I)	TORNILLO 5x40	(I)		04
PARAFUSO ESC PHI ZP/BC 7x60	(J)	7x60 SCREW	(J)	TORNILLO 7x60	(J)		02
PARAFUSO ESTR CHA PHI ZP 5x40	(K)	5x40 SCREW	(K)	TORNILLO 5x40	(K)		06
PARAFUSO ESTR CHA PHI ZP 5x50	(L)	5x50 SCREW	(L)	TORNILLO 5x50	(L)		08
PARAFUSO MA CHA PHI ZB M4	(M)	M4 SCREW	(M)	TORNILLO M4	(M)		04
PARAFUSO MA CHA PHI ZB M6	(N)	M6 SCREW	(N)	TORNILLO M6	(N)		04
PARAFUSO MA CHA PHI ZB M8	(O)	M8 SCREW	(O)	TORNILLO M8	(O)		04
PARAFUSO MOV SX I SOB 7x80	(P)	7x80 SCREW	(P)	TORNILLO 7x80	(P)		04
PARAFUSO MINIFIX	(Q)	MINIFIX SCREW	(Q)	TORNILLO MINIFIX	(Q)		04
PASSA FIO 40mm	(R)	40mm CABLE PASS	(R)	PASACABLE 40mm	(R)		01
SACHE DE COLA 10grs	(S)	10gr GLUE SACHET	(S)	SACHET DE PEGAMENTO 10gr	(S)		01
SUPORTE DE VIDRO PINO 7,5x3,5	(T)	7.5x3.5 GLASS SUPPORT	(T)	SOPORTE CRISTAL 7.5x3.5	(T)		08
TAMBOR MINIFIX 12x10mm	(U)	12x10mm MINIFIX NUT	(U)	TUERCA MINIFIX 12x10mm	(U)		04
TAMPA BOTAO INOX	(V)	STAINLESS STEEL CAP	(V)	TAPA ACERO INOXIDABLE	(V)		04
CHAVE ALLEN	(W)	ALLEN KEY	(W)	CLAVE ALLEN	(W)		01

RELAÇÃO DE PEÇAS | PARTS LIST | LISTADO DE PARTES

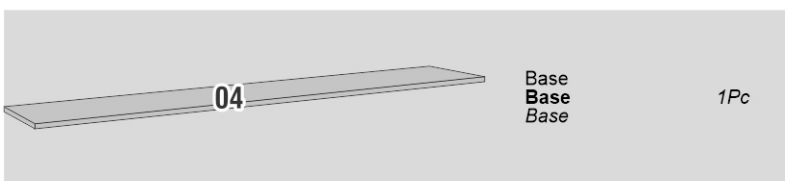
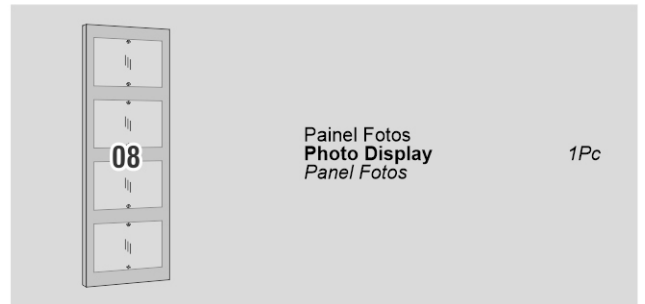
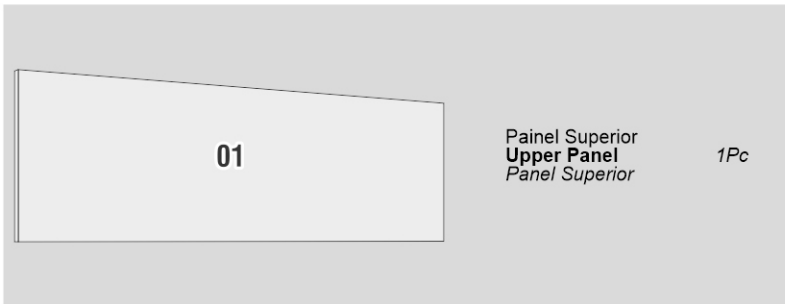
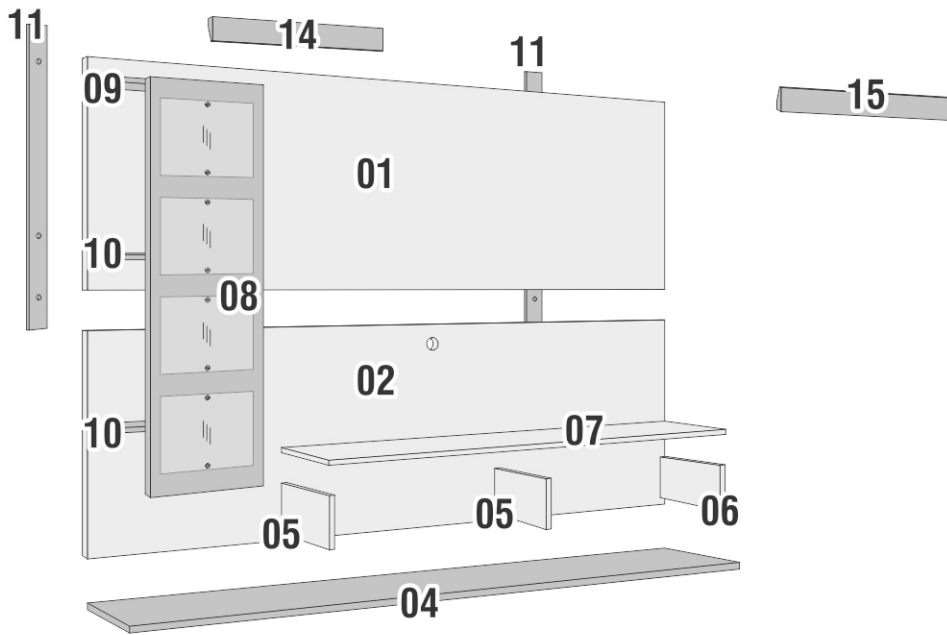

Passo 01 COMECE A MONTAGEM PELAS PEÇAS 01 E 02 PARAFUSAR COM CHAPA UNIÃO(E+F), PARAFUSE A PEÇA 14 COM PARAFUSO 4x25(H) NA PEÇA 01 E PARAFUSE AS PEÇAS 11 NAS PEÇAS 01 E 02 COM PARAFUSO 4x25(H).
Step 01 START ASSEMBLING FROM PARTS 01 AND 02 SCREW WITH 4-HOLE CONECTION PLATE(E+F), SCREW PART 14 WITH 4x25 SCREW(H) INTO PART 01 AND SCREW PART 11 INTO PARTS 01 AND 02 WITH 4x25 SCREW(H).
 Paso 01 EMPIECE EL MONTAJE POR LAS PARTES 01 Y 02 ATORNILLE CON PLACA DE UNIÓN 4 AGUJEROS(E+F), ATORNILLE LA PARTE 14 CON TORNILLO 4x25(H) A LA 01 Y ATORNILLE LA PARTE 11 A LAS 01 Y 02 CON TORNILLO 4x25(H).

Passo 02 PARAFUSE AS PEÇAS 05 E 06 NA PEÇA 04 COM PARAFUSO 5x50(L).
Step 02 SCREW PARTS 05 AND 06 INTO PART 04 WITH 5x50 SCREW(L).
 Paso 02 ATORNILLE LAS PARTES 05 Y 06 A LA 04 CON TORNILLO 5x50(L).

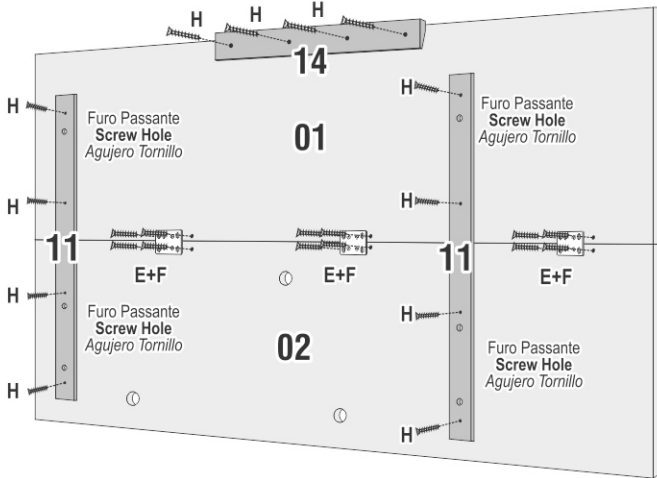

E = 3

F = 12

H = 12

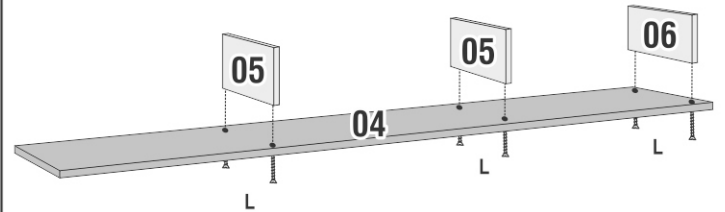

L = 6

Passo 03 PARAFUSE A PEÇA 07 NAS PEÇAS 05 E 06 COM MINIFIX(Q+U).
Step 03 SCREW PART 07 INTO PARTS 05 AND 06 WITH MINIFIX(Q+U).
 Paso 03 ATORNILLE LA PARTE 07 A LAS 05 Y 06 CON MINIFIX(Q+U).

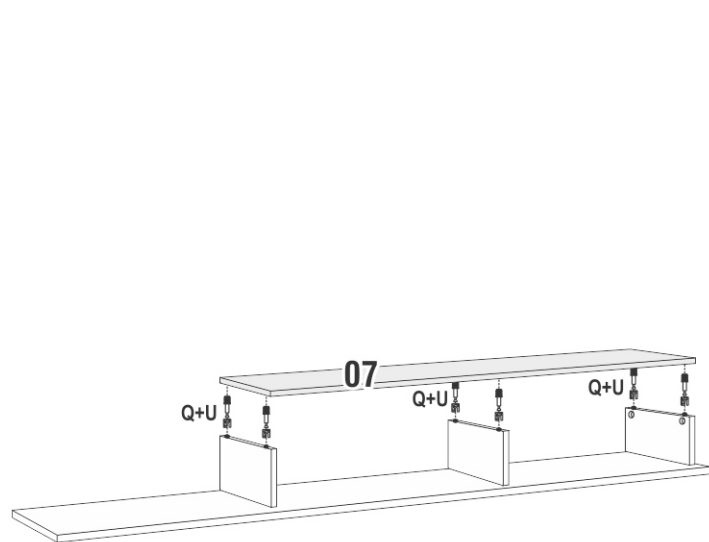

Q = 6

U = 6

Passo 04 FIXE AS PEÇAS 09 E 10 NA PEÇA 08 COM MINIFIX(Q+U). PARAFUSE A PEÇA 08 NA PEÇA 04 COM PARAFUSO 5x50(L).
Step 04 ATTACH PARTS 09 AND 10 TO PART 08 WITH MINIFIX(Q+U). SCREW PART 08 INTO PART 04 WITH 5x50 SCREW(L).
 Paso 04 FIJE LAS PARTES 09 Y 10 A LA PARTE 08 CON MINIFIX(Q+U). ATORNILLE LA PARTE 08 A LA 04 CON TORNILLO 5x50(L).

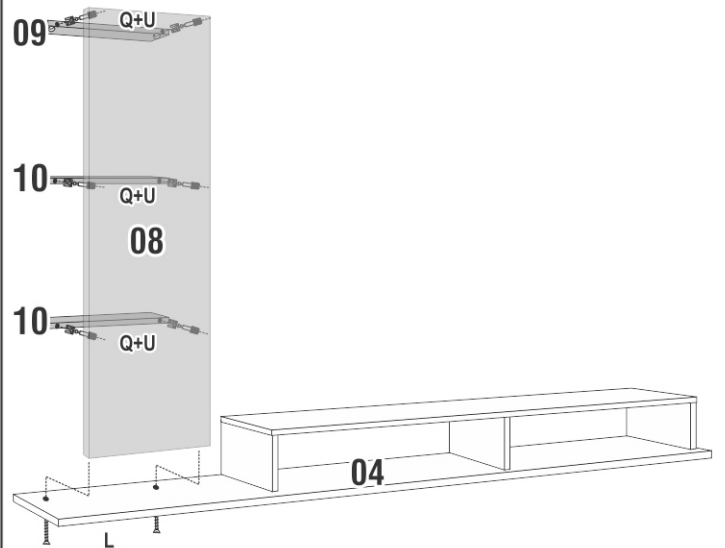

L = 2

Q = 6

U = 6

Passo 05 PARAFUSE AS PEÇA 01 E 02 NAS PEÇAS 04, 07, 09 E 10 COM PARAFUSO 5x50(L) E CAVILHA(D).
Step 05 SCREW PARTS 01 AND 02 INTO PARTS 04, 07, 09 AND 10 WITH 5x50 SCREW(L) AND DOWEL(D).
 Paso 05 ATORNILLE LAS PARTS 01 Y 02 A LAS PARTES 04, 07, 09 Y 10 CON TORNILLO 5x50(L) Y CLAVIJA(D).

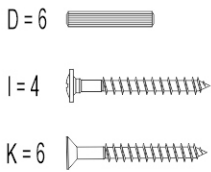
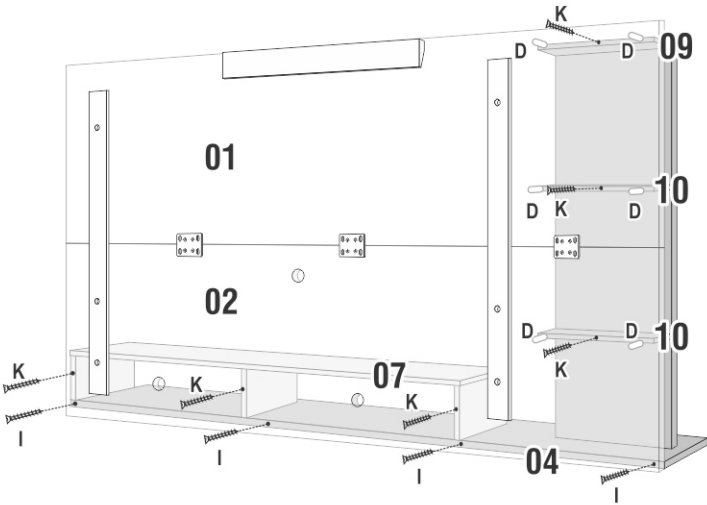

Passo 06 PARAFUSE OS VIDROS DO PORTA RETRATO NA PEÇA 08 COM O SUPORTE DE VIDRO 7,5x3,5(T).
Step 06 SCREW THE PHOTO DISPLAY GLASS PANELS INTO PART 08, WITH 7.5x3.5 GLASS SUPPORT(T).
 Paso 06 ATORNILLE LOS CRISTALES DEL PANEL DE FOTOS A LA PARTE 08 CON SOPORTE CRISTAL 7,5x3,5(T).

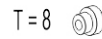
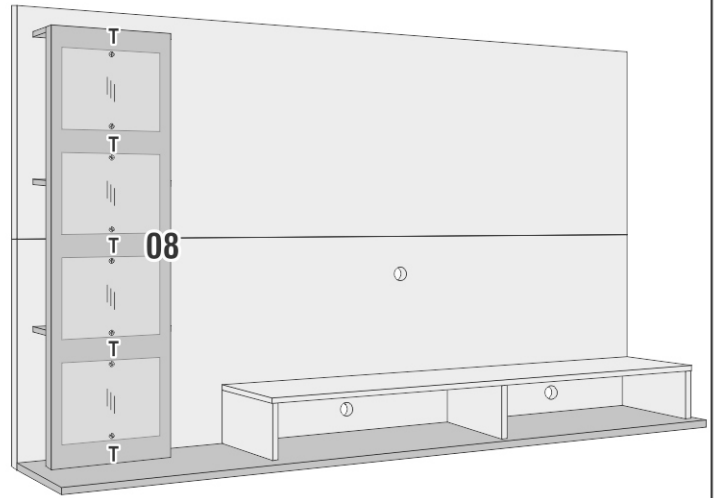

Passo 07 COLOQUE O SUPORTE DE TV.
Step 07 MOUNT THE TV RACK.
 Paso 07 PONGA EL SOPORTE DE TV.

SIGA AS ORIENTAÇÕES QUE SE ENCONTRAM DENTRO DO KIT DO SUPORTE.
FOLLOW THE INSTRUCTIONS THAT ARE INSIDE THE TV RACK KIT.
 SIGA LAS INSTRUCCIONES QUE SE ENCUENTRAN EN EL KIT DEL SOPORTE DE TV.

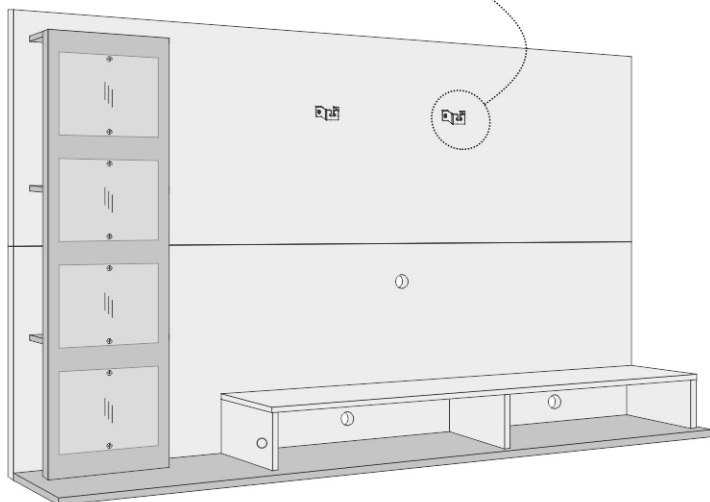
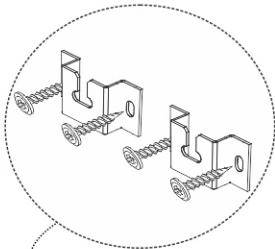

Passo 08 PARAFUSE NA PAREDE A PEÇA 15 COM PARAFUSO 7x50 E BUCHA (J+C) E COLOQUE O PAINEL JÁ MONTADO NA MESMA PARAFUSANDO O PAINEL TAMBÉM NA PAREDE COM PARAFUSO 7x60, BUCHA E TAMPA CROMADA (C+P+V).
Step 08 SCREW PART 15 INTO THE WALL WITH 7x50 SCREW AND ANCHOR (J+C), AND ATTACH THE PANEL ALREADY ASSEMBLED. ALSO SCREW THE PANEL INTO THE WALL WITH 7x60 SCREW, ANCHOR AND CHROME CAP (C+P+V).
 Paso 08 ATORNILLE LA PARTE 15 A LA PARED CON TORNILLO 7x50 Y TACO (J+C). COLOQUE EL PANEL YA MONTADO Y ATORNILLELO TAMBIÉN A LA PARED CON TORNILLO 7x60, TACO Y TAPA CROMADA (C+P+V).

