

**BELMAX**

Móveis

**ESQUEMA DE MONTAGEM**

ASSEMBLY INSTRUCTIONS  
INSTRUCCIONES DE MONTAJE

**MÓDULO 450 PRATELEIRA SUPREME**

NECESSÁRIO / NECESSARY / NECESIDAD



FERRAMENTAS NÃO INCLIDAS  
NO TOOLS INCLUDED  
HERRAMIENTAS NO INCLUIDAS

Fer. **203311**

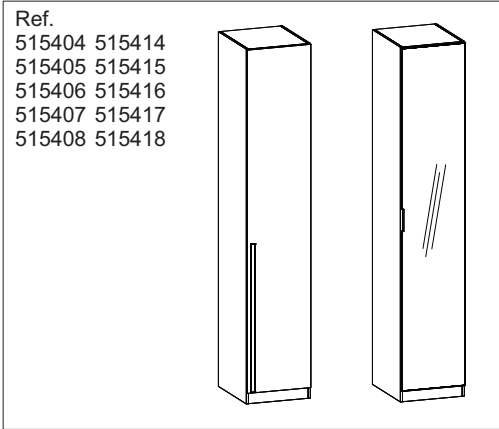

CÓD.	Nº	PEÇA	QUAN.
240492	01	Base/Teto 420x514x15	02
221168	02	Costa 1880x440x03	01
240499	03	Costa 444x440x03	01
222316	04	Lateral Dir.2400x514x15	01
222317	05	Lateral Esq.2400x514x15	01
225318	06	Prat. Fixa 420x430x15	01
225319	07	Prat. Maleiro 420x514x15	01
221167	08	Rodapé 420x72x15	01
225210	09	Prat. Movel 420x430x15	03

CÓD.	Nº	PEÇA	QUAN.
222318	10	Porta 2323x446x15	01
		OU	
22392	11	Porta Esp. 2323x446x15	01

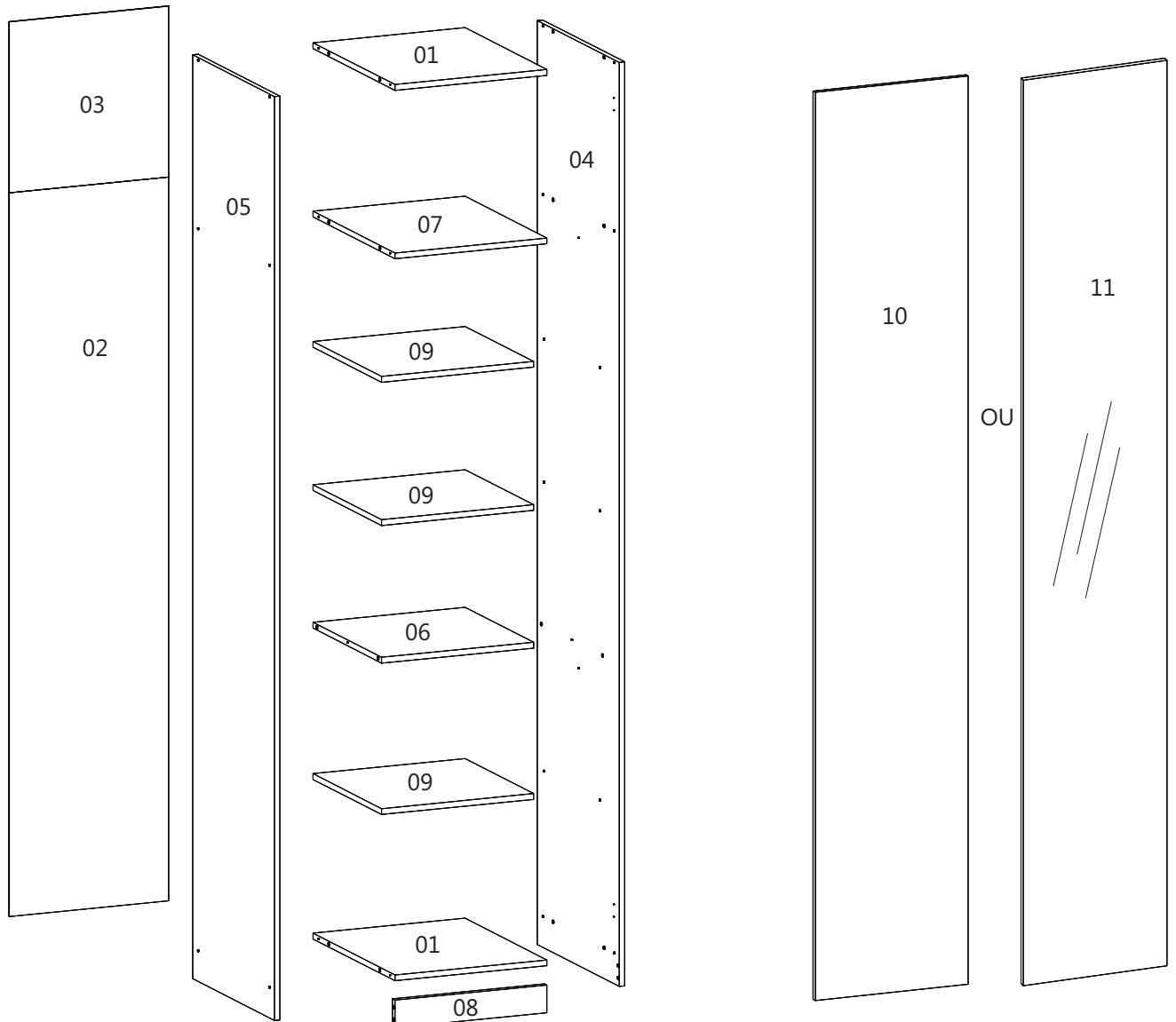
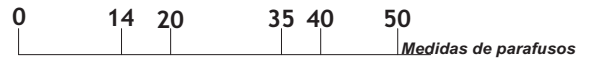
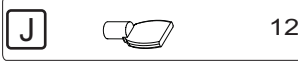
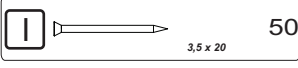
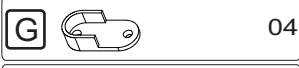
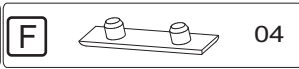
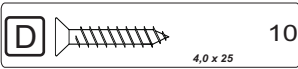
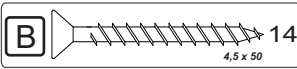
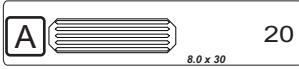



FERRAMENTAS NÃO INCLUIDAS  
NO TOOLS INCLUDED  
HERRAMIENTAS NO INCLUIDAS

**01** Encaixar as sapatas (F) nas laterais (04, 05).

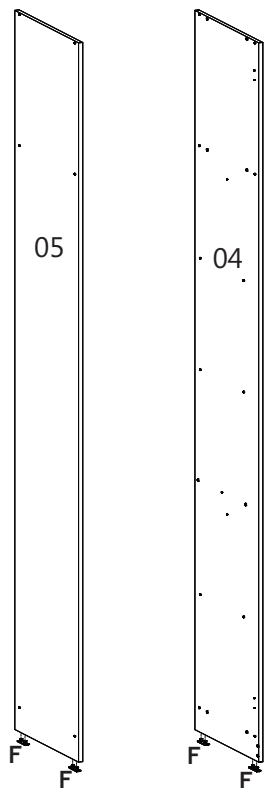

**02** Fixar laterais esquerda (05) e direita (04) no teto base (01), maleiro (07), prateleira fixa (06) e rodapé (08).

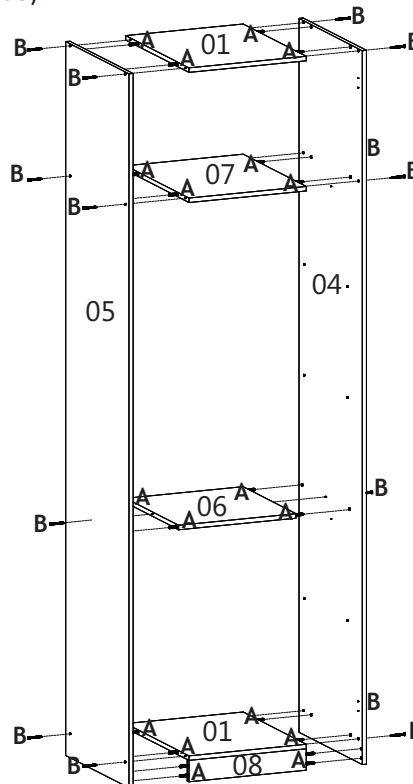

**03** Colocar suporte cabideiro (G), suporte prateleira (J) ou configure conforme sua necessidade.

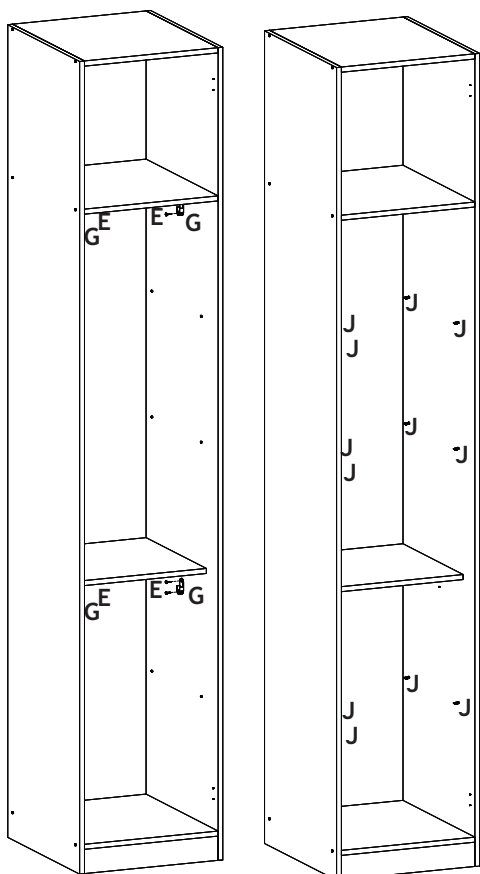

**04** Pregar (I) costas do módulo (02, 03).

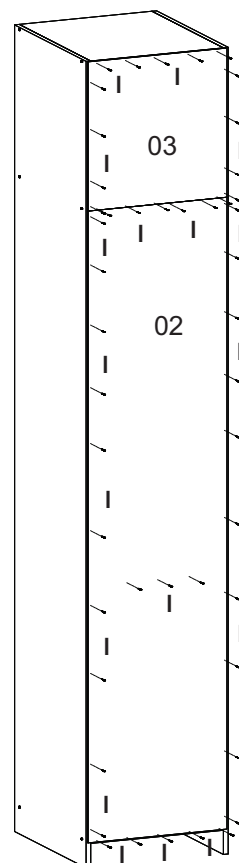



FERRAMENTAS NÃO INCLuíSAS  
NO TOOLS INCLUDED  
HERRAMIENTAS NO INCLUIDAS

**05** Encaixar prateleira (09) e cabideiro conforme configuração desejada.

Cabideiro/Calceir

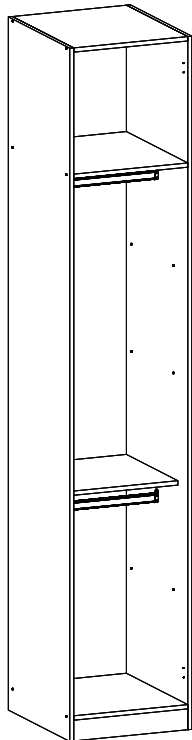

Prateleiras

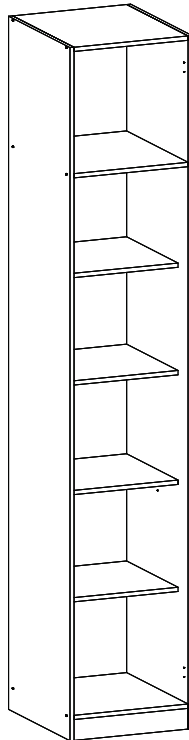

Cabideiro/Pratelei

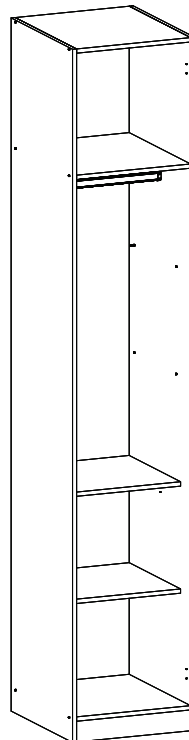

Prateleira/Calceir

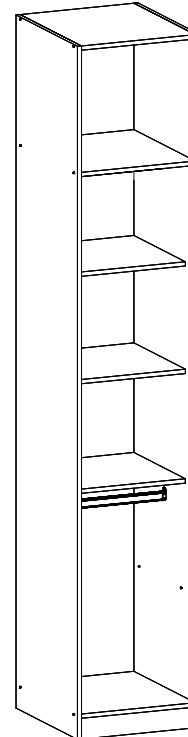

**06** Prender dobradiça (K) na porta.

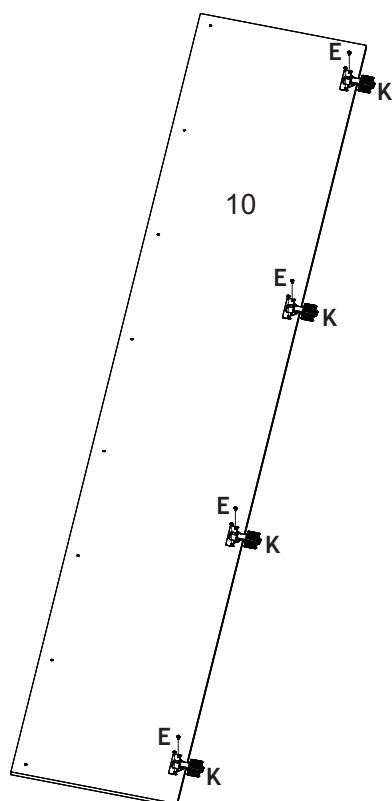

**07** Fixar a porta (10) ou porta espelho (11) no módulo conforme marcação na lateral.

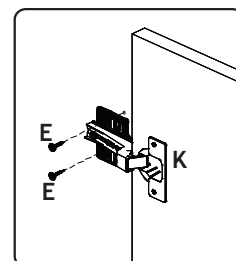
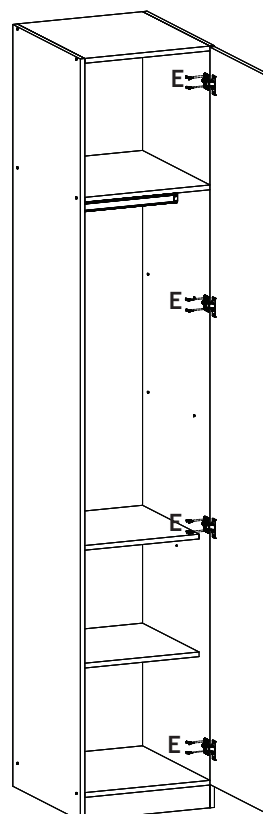



FERRAMENTAS NÃO INCLUSAS  
NO TOOLS INCLUDED  
HERRAMIENTAS NO INCLUIDAS

### OPÇÕES DE ABERTURA DA PORTA

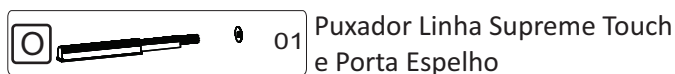
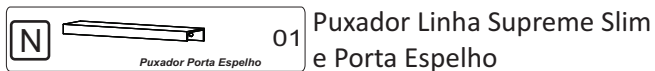

**08** Fixe o sistema de abertura da porta conforme produto adquirido. Puxador (M) na pré-furação, puxador (N) na altura de 1m ou de sua preferência, ou pulsador (tip-on) na opção de porta sem puxador. Colar tapa-furos (L) em todos os parafusos e furos aparentes.

