

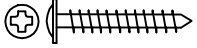

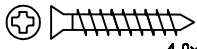









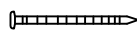
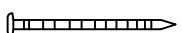

















LEGENDA						
COD. ASSISTENCIA	PEÇAS	QTD	COMPR	LARG	ESPESS	CAIXA
01	PORTA DIREITA	01	2191mm	762mm	15mm	C
02	PORTA ESQUERDA DOS ESPELHOS	01	2191mm	762mm	15mm	B
03	LATERAL DIREITA	01	2320mm	512mm	15mm	A
04	LATERAL ESQUERDA	01	2320mm	512mm	15mm	A
05	CHAPÉU	01	1571mm	512mm	15mm	D
06	BASE	01	1571mm	512mm	15mm	D
07	BASE DO MALEIRO	01	1571mm	448mm	15mm	A
08	RODAPÉ FRONTAL	01	1571mm	60mm	15mm	D
09	RODAPÉ TRASEIRO	01	1571mm	60mm	15mm	D
10	RODAPÉ INTERNO	01	456mm	60mm	15mm	D
11	DIVISÓRIA	01	1839mm	448mm	15mm	A
12	PRATELEIRA DO CALCEIRO	01	810mm	192mm	15mm	D
13	PRATELEIRAS	02	746mm	448mm	15mm	D
14	TAMPO DE GAVETA	01	746mm	448mm	15mm	D
15	PILASTRA	01	350mm	96mm	15mm	D
16	RODAFORRO	01	1602mm	64mm	15mm	A
17	FRENTE DE GAVETA	03	737mm	160mm	15mm	A
18	LATERAL DE GAVETA	06	420mm	120mm	15mm	D
19	CABECEIRA DE GAVETA	03	692mm	120mm	15mm	D
20	COSTAS MENORES	02	1857mm	412mm	3mm	A
21	COSTA MAIOR	01	1857mm	764mm	3mm	C
22	COSTA MALEIRO	01	1592mm	367mm	3mm	A
23	FUNDO DE GAVETA	03	705mm	418mm	3mm	D

	CÓD.	FERRAGEM	QTDE.
A	2592	 PARAFUSO FLANGE ZINCADO BRANCO 4,0x40	10
B	226	 PARAFUSO CHATO 4,0x40 BICROMATIZADO	03
C	1828	 PARAFUSO PANELA 3,5x14 ZINCADO BRANCO	08
D	4214	 PARAFUSO CHATO 3,5x14 ZINCADO BRANCO	101
E	5256	 PARAFUSO CHATO 4,0x20 BICROMATIZADO	12
F	1901	 SAPATA DESLIZADORA PRETA 15X6	08
G	107	 PREGOS 10X10	135
H	149	 PREGOS 13X15	09
I	1802	 CAVILHA 6x30MM	64
J	1925	 CAVILHA 6x50MM	03
K	1423	 FIXADOR DE COSTA	27

L	85	 "L" DE METAL	08
M	41	 COLA BRANCA EM BISNAGA	01
N	4860	 ROLETE SEM REGULAGEM	02
O	4860	 ROLETE COM REGULAGEM	02
P	4860	 GUIA METALICO	04
Q	40534	 GOTA DE SILICONE C/ LOGO "K"	08
R	58	 kappesberg móveis	01
S	9371	 PUXADOR DE CHAPA CROMADO	02
T	5288	 CORREDIÇA 400MM (DE METAL)BRANCA	03
U	1446	 SUPORTE CABIDEIRO DE PLÁSTICO	04
V	18458	 SUPORTE TRIANGULAR PRETO	12
W	30945	 PARAFUSO MINIFIX	29
X	30950	 TAMBOR MINIFIX	29

Y	2347	 TAMPA MINIFIX BRANCO	29
Y	14855	 TAMPA MINIFIX CARVALLE	29
Z	10035	 ROLICO OBLONGO 16X30 ALUMINIO FRISADO 80,2	02
AA	899	 CANTONEIRA DE METAL	09
AB	21164	 TRILHO PLASTICO ALUMINIO 1570MM	02
AC	25671	 BARRA DE METAL BRANCO PORTA DE CORRER 219,1CM	04
AC	25672	 BARRA DE METAL ASPEN PORTA DE CORRER 219,1CM	04
AD	21163	 TRILHO DE ALUMINIO 1570MM	02
AE	16346	 PERFIL H 1840MM BEGE	01
AE	12300	 PERFIL H 1840MM BRANCO	01
AF	25670	 ESPELHO 75,4 X 72,5 (4MM)	03

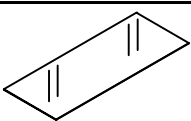
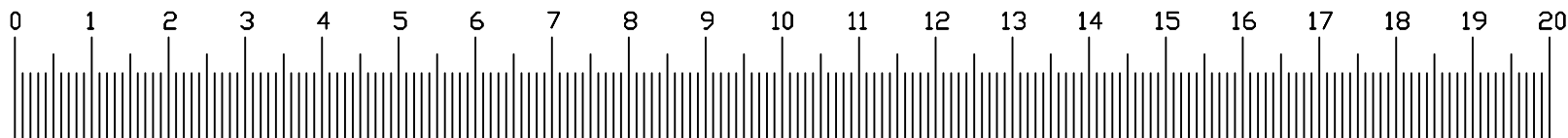

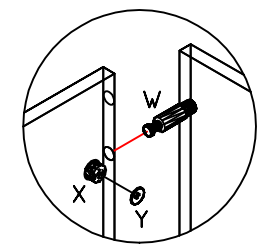
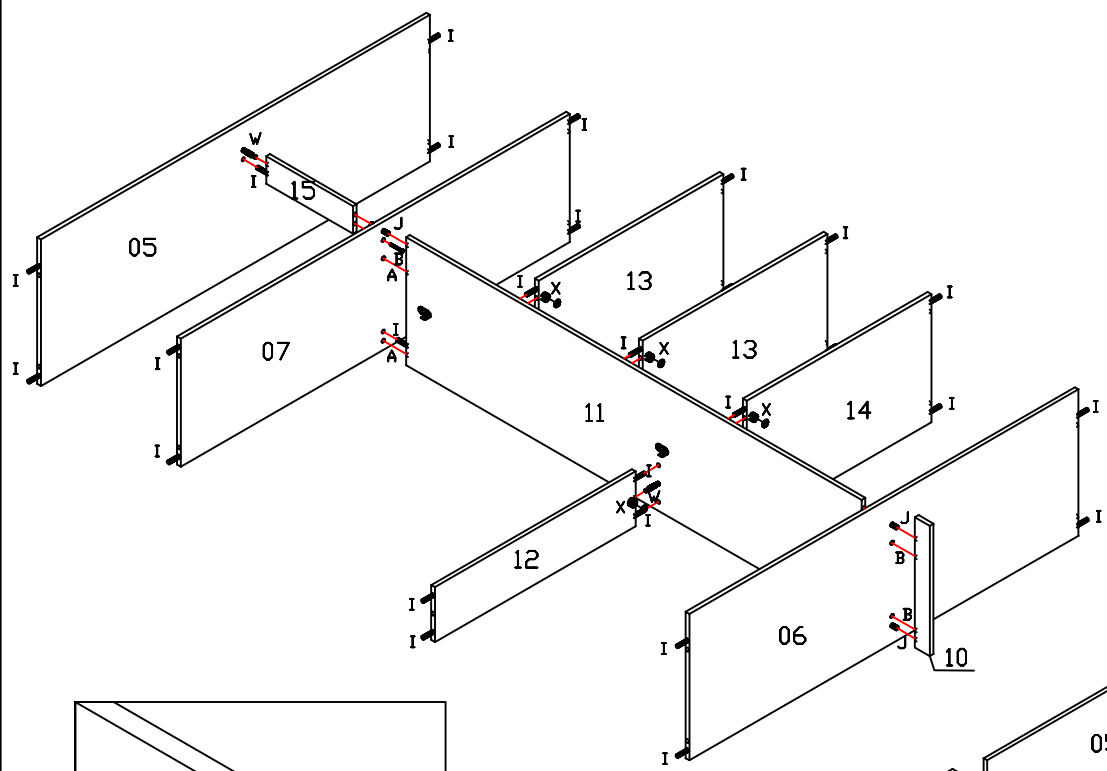

DETALHE MINIFIX

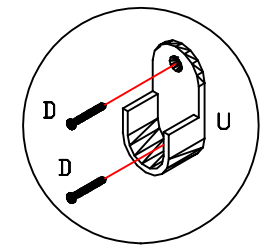

SUPORTE CABIDEIRO

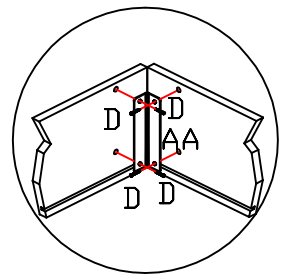
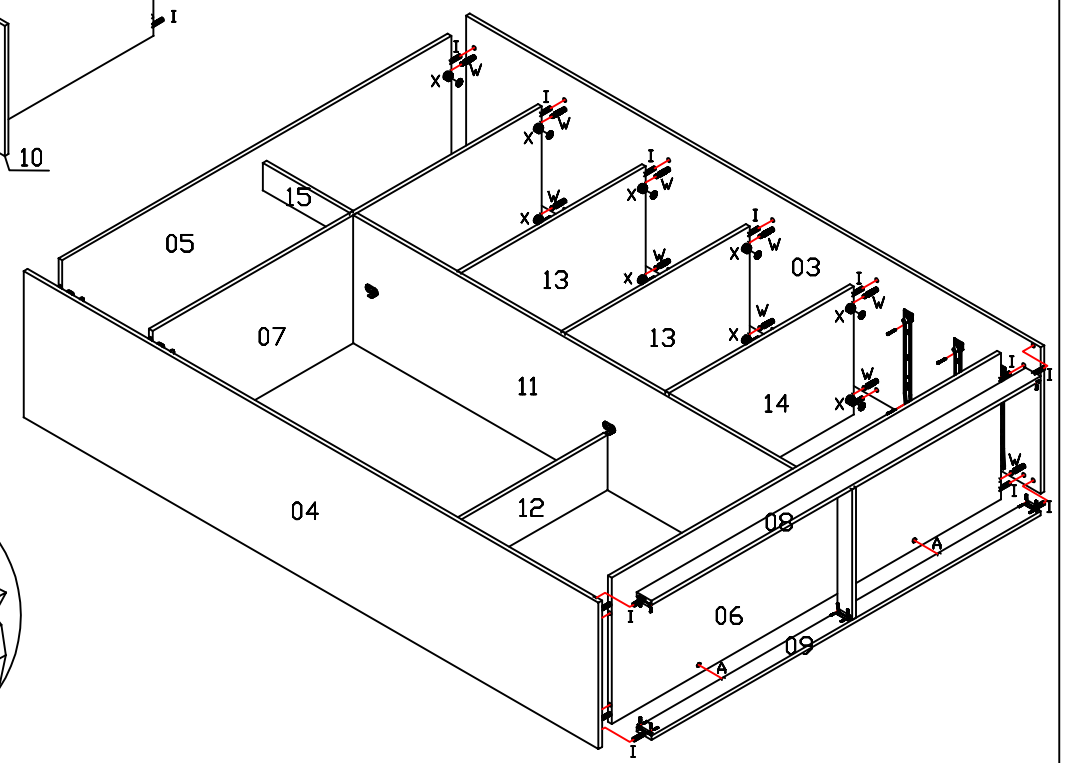
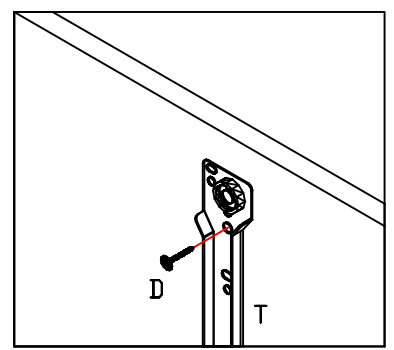

USAR CANTONEIRA "AA" PARA
FIXAR OS RODAPÉS UNS AOS
OUTROS E LATERAIS
UTILIZANDO O PARAFUSO "D".

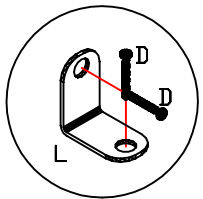
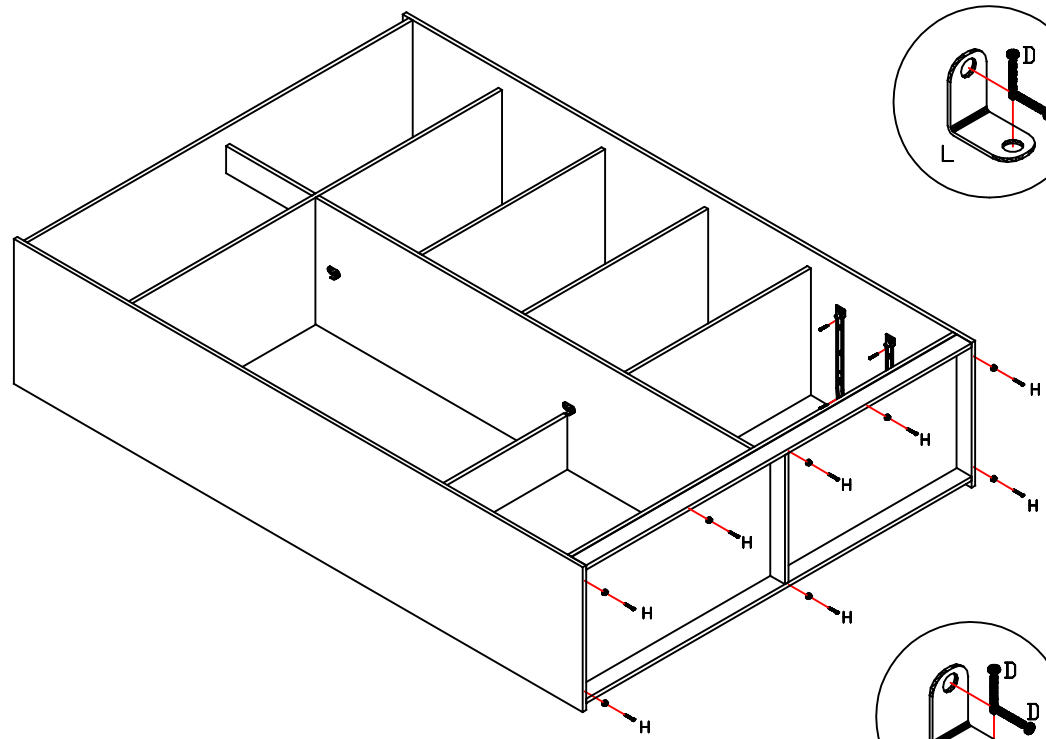

USAR L DE METAL "L" PARA FIXAR OS RODAPÉ FRONTE NA BASE UTILIZANDO O PARAFUSO "D".

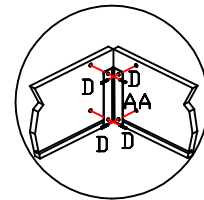

USAR CANTONEIRA "AA" PARA FIXAR O RODAFORRO NO CHAPEU UTILIZANDO O PARAFUSO "D".

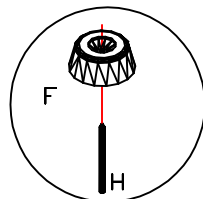

SAPATA

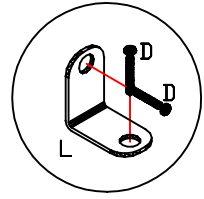

"L" DE METAL PARA PRENDER A FRENTE DE GAVETA

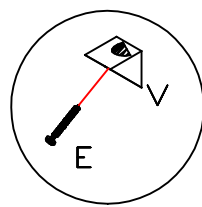
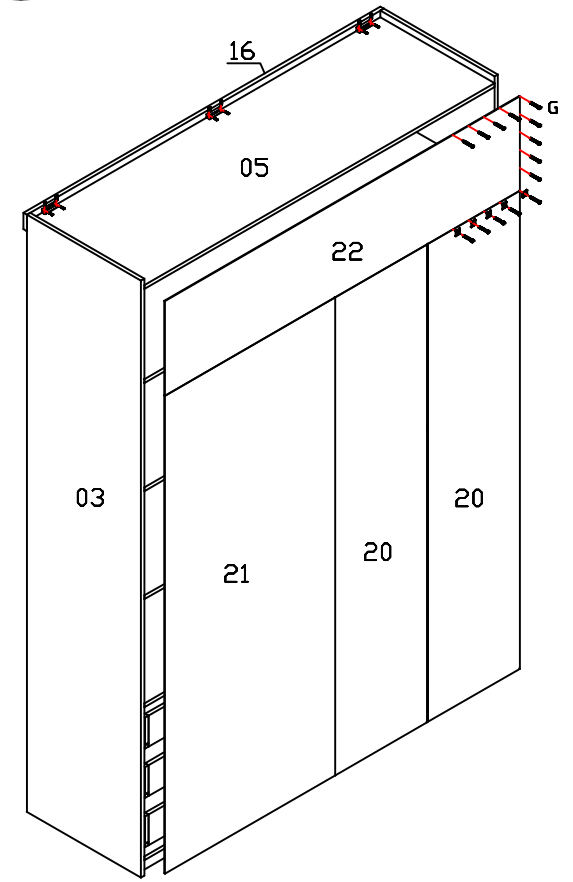
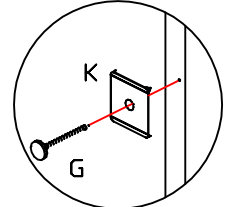

DETALHE DO SUPORTE DE GAVETA ESTE DEVE SER FIXADO ABAIXO DO FUNDO DE GAVETA DOIS NA FRETE E DOIS ATRAS APOS A GAVETA ESTAR MONTADA

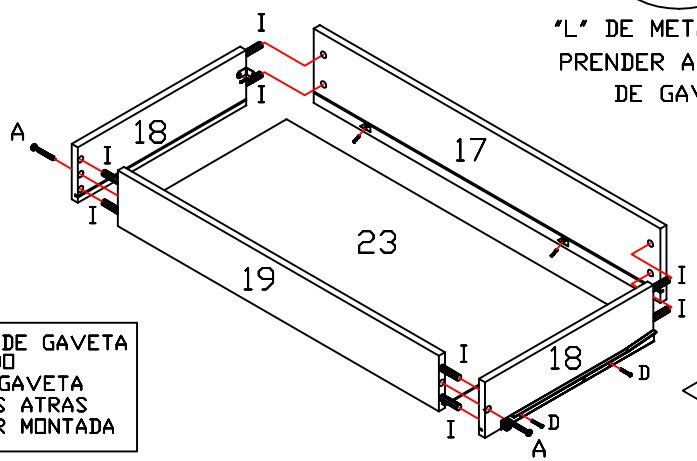

"Obs: Colocar os parafusos da correção pelo lado e não por baixo."

kappesberg móveis
www.kappesberg.com.br

Rua Emancipação 2000- Tupandi-RS
Fone: (51) 3635-8800
www.kappesberg.com.br

A529

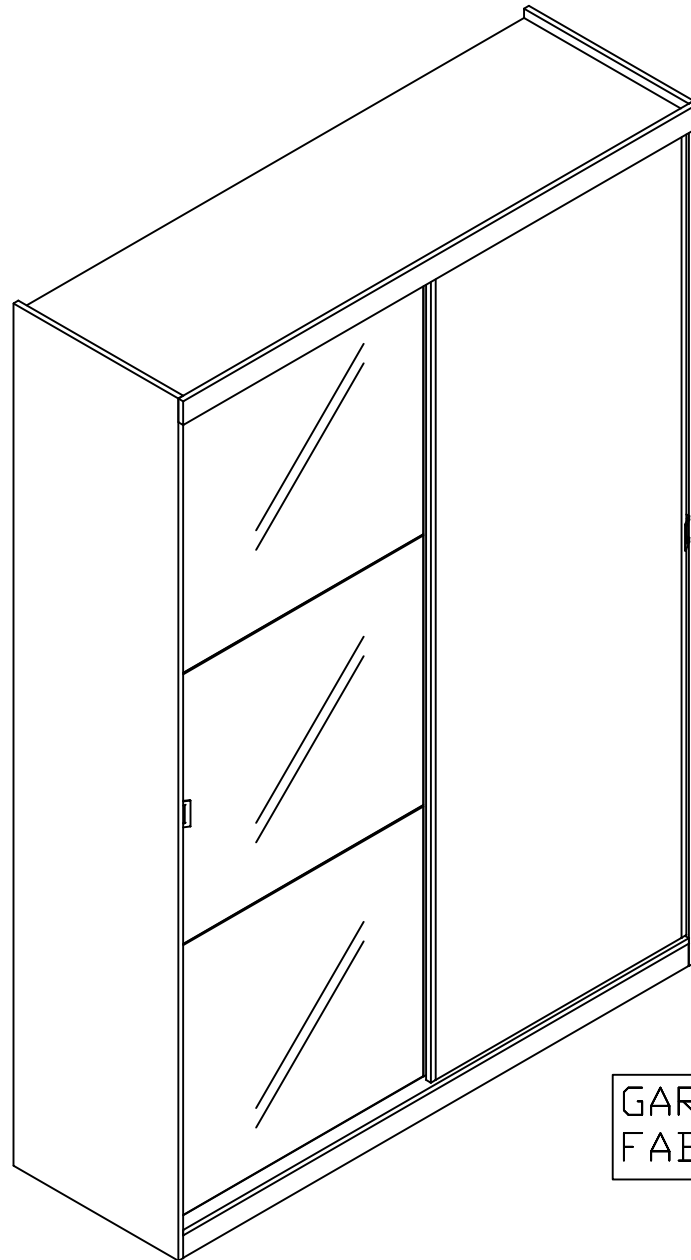

GARANTIA POR DEFEITOS DE
FABRICAÇÃO DE 03 MESES.

IMPORTANTE

A529

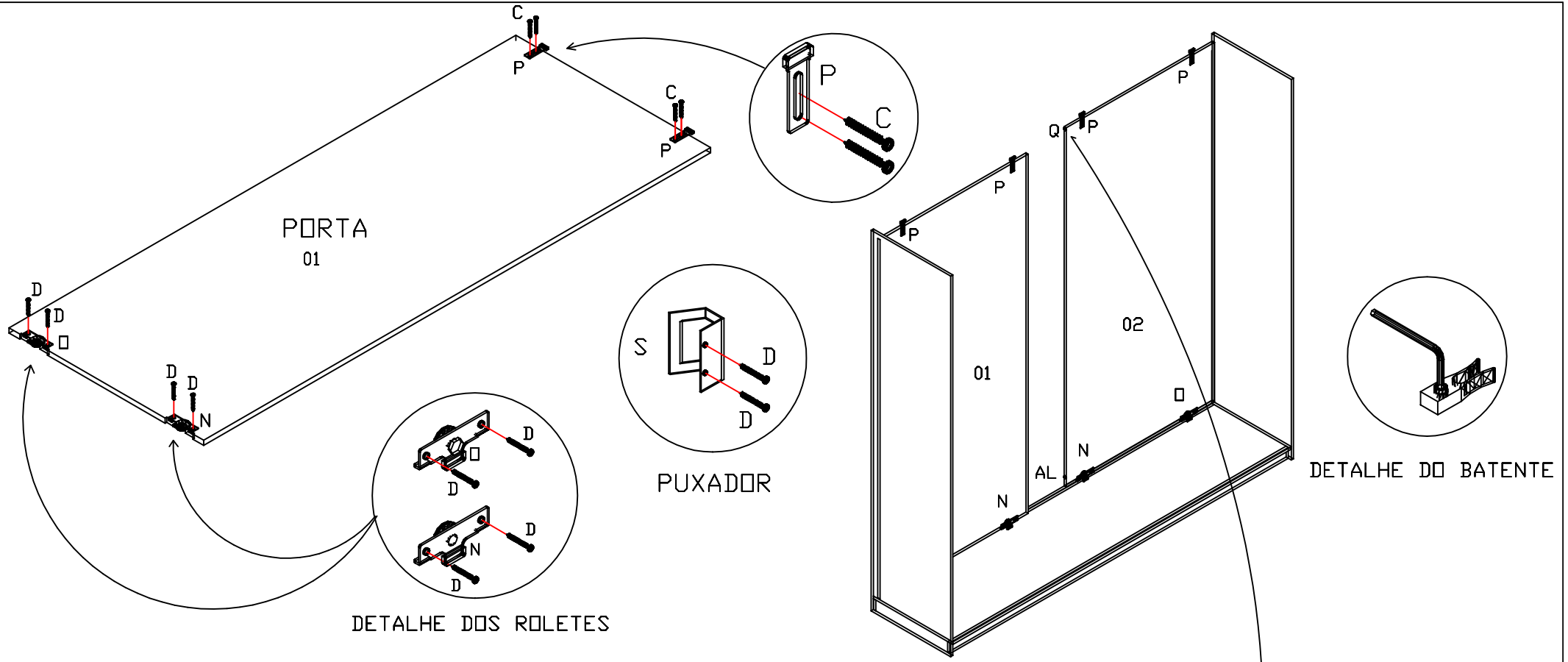

Para melhor montar as portas coloque o rolete com regulagem "□" no lado do puxador e o rolete sem regulagem "N" no lado oposto do puxador. □s guias "P" devem ser fixados com um parafuso "C", mais não deve ser apertado antes de encaixar a porta no trilho de alumínio. Após encaixar a porta no móvel levante o guia "P" p/ dentro do trilho, mais não o preione demais contra o trilho (deixar uma folga entre o guia e o trilho, para que a porta deslize melhor) que está no chapéu e aperte bem o parafuso. Em seguida coloque o segundo parafuso em cada guia.

□bs: No acessório contem 8 Gotas de Silicone "Q" que devem ser colodas nas portas, para que as mesmas não batam com tanta força nas laterais e uma na outra.

- ① As portas não devem bater nas laterais do roupeiro. Devem parar 2mm antes. Para isso regule o batente plástico que está colocado dentro dos trilhos de alumínio do chapéu.
- ② A porta não pode bater no puxador da outra porta. Ajuste o batente.