

ARMÁRIO LIMEIRA - ALTO

High organizer cabinet Limeira
Armario organizador Limeira - alto

Código **3265** | Revisão 13

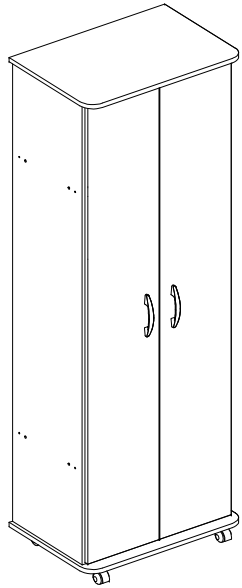

PESO MÁXIMO SUPORTADO PELAS PEÇAS, SENDO ESTE DISTRIBUÍDO UNIFORMEMENTE.

Maximum weight supported by parts, being this evenly distributed.
Peso máximo soportado por las partes, siendo esta distribuido uniformemente.

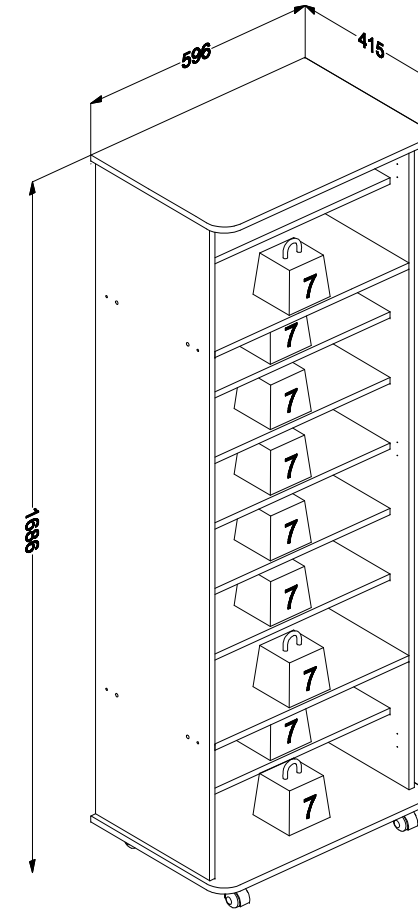

Você vai precisar de/ You will need / Usted necesitará

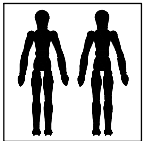

2 Pessoas
2 people
2 personas

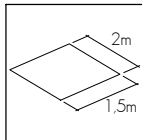

Espaço recomendado para montagem
Recommended space for assemble
Espacio recomendado para el armado

Ferramentas não inclusas
Tools not included / Herramientas no incluidas

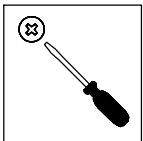

Chave Philips
Screwdriver
Destornillador cruz

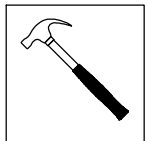

Martelo
Hammer
Martillo











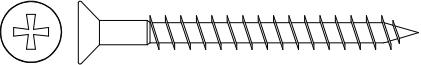

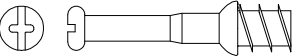

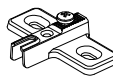
* PESO EM KG/ Weight in Kg/ Peso en Kg
DIMENSÕES EM MM/ Dimensions in mm/ Dimensiones en mm

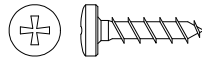
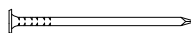
IDENTIFICAÇÃO DOS ACESSÓRIOS/ IDENTIFICATION OF ACCESSORIES/ IDENTIFICACIÓN DE ACCESORIOS

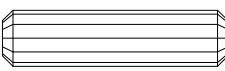
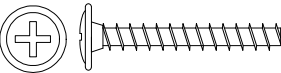
NOTAS: A separação dos acessórios antes de iniciar a montagem facilitará a mesma. Os parafusos e cavilhas estão na escala real. Em caso de dúvida na identificação, coloque o acessório sobre a imagem.

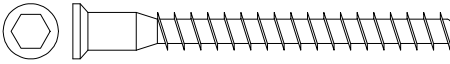
NOTES: The separation of the accessories before you start the assembly will facilitate the same. The screws and dowels are in real scale. In case of doubts about the identification, place the accessory on the image.

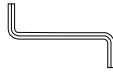
NOTAS: La separación de los accesorios antes de comenzar el armado facilitará el mismo. Los tornillos y taquetes son en escala real. En caso de dudas sobre la identificación, coloque el accesorio en la imagen.

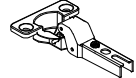
A		Parafuso chato Flat head screw Tornillo de cabeza plana	4,5x45 mm	04	P		Tapa furo plástico Tapones plásticos Plastic hole plugs	8 mm	08
B		Haste minifix simples Simple minifix screw Tornillo minifix simple	-	04	10		Perfil "H" Profile "H" Perfil "H"	1603 mm	01
C		Calço dobradiça Hinge support Bisagra de calce	-	06	11		Rodízio Caster Ruedas	-	04
D		Parafuso panela Pan head screw Tornillo de pan	3,5x14 mm	40					
E		Prego Nail Clavo	10 x10	45					
F		Puxador Handle Tirador	-	02					
G		Cavilha Wooden Dowel Pin	8x30 mm	16					
H		Parafuso flangeado Flanged head screw Tornillo de cabeça flangeada	3,5x25 mm	04					
I		Tambor minifix Drum lock Tambor minifix	12 mm	04					
J		Tapa furo adesivo Bore patch adhesive Tapones adhesivo	-	04					
K		Parafuso estrutural Structural screw Tornillo estrutural	5,0x50 mm	08					
L		Tampa parafuso estrutural Structural screw cover Tapa tornillo estrutural	-	08					
M		Chave allen Allen key Llave Allen	-	01					
N		Suporte prateleira Shelf support Soporte de repisa	8x7 mm	28					
O		Dobradiça curva Metal hinge curve Esquina de bisagra metálica	26 mm	06					

IDENTIFICAÇÃO DAS PEÇAS/ PARTS IDENTIFICATION/ IDENTIFICACIÓN DE LAS PIEZAS

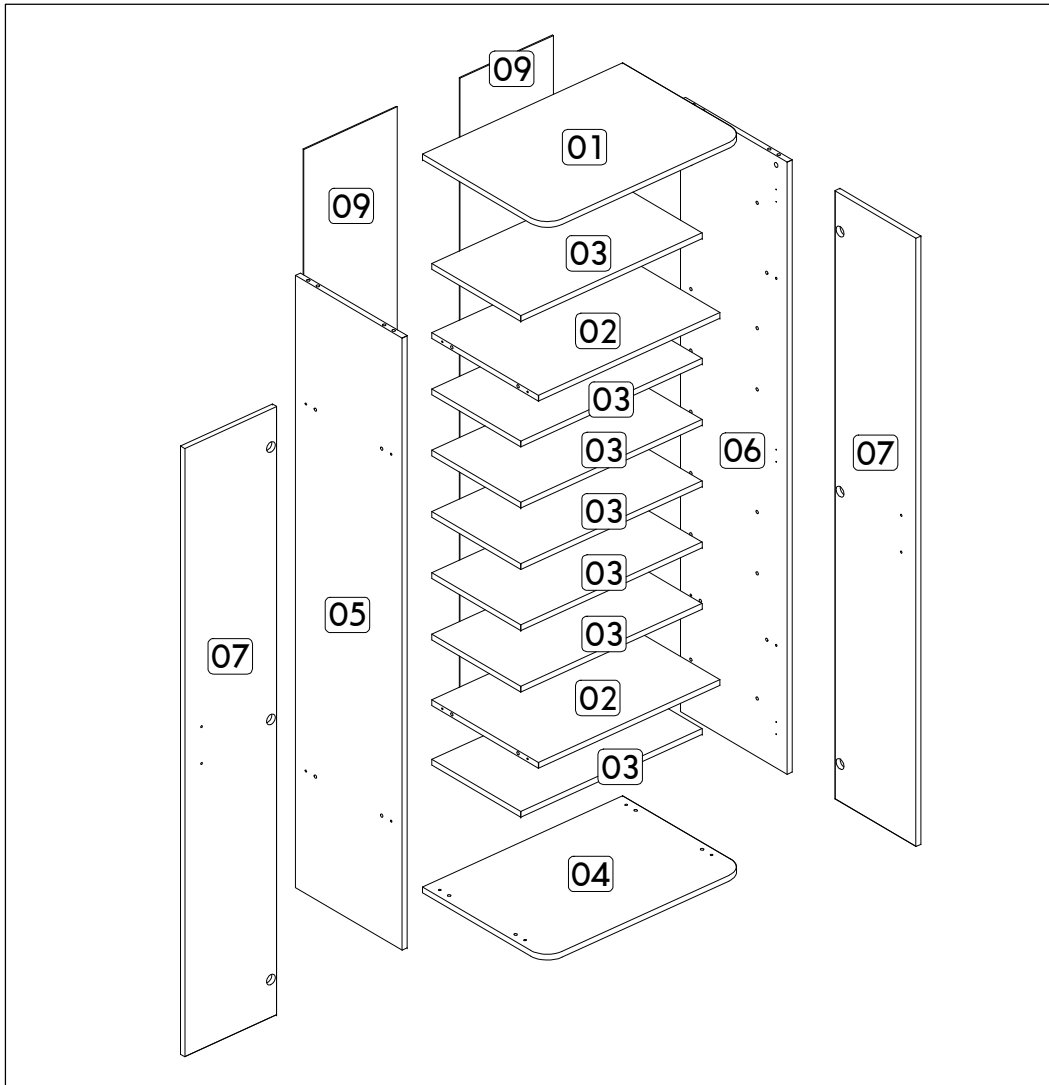

Nº	DESCRIÇÃO - DESCRIPTION - DESCRIPCIÓN	MEDIDAS-MEASURES - MEDIDAS (mm)	QTD.
01	Base superior - Top base - Base superior	596 x 415 x 15	01
02	Base - Base - Base	540 x 360 x 15	02
03	Prateleira móvel - Mobile shelf - Repisa móvil	540 x 300 x 15	07
04	Base inferior - Bottom base - Base inferior	596 x 415 x 15	01
05	Lateral esquerda - Left side - Lateral izquierda	1598 x 360 x 15	01
06	Lateral direita - Right side - Lateral derecha	1598 x 360 x 15	01
07	Porta direita/esquerda - Right and Left Door - Puerta derecha/izquierda	1588 x 274 x 15	02
09	Costa - Back - Fondo	1618 x 278 x 03	02

PRÉ-MONTAGEM/ PRE-ASSEMBLE/ PRE ARMADO

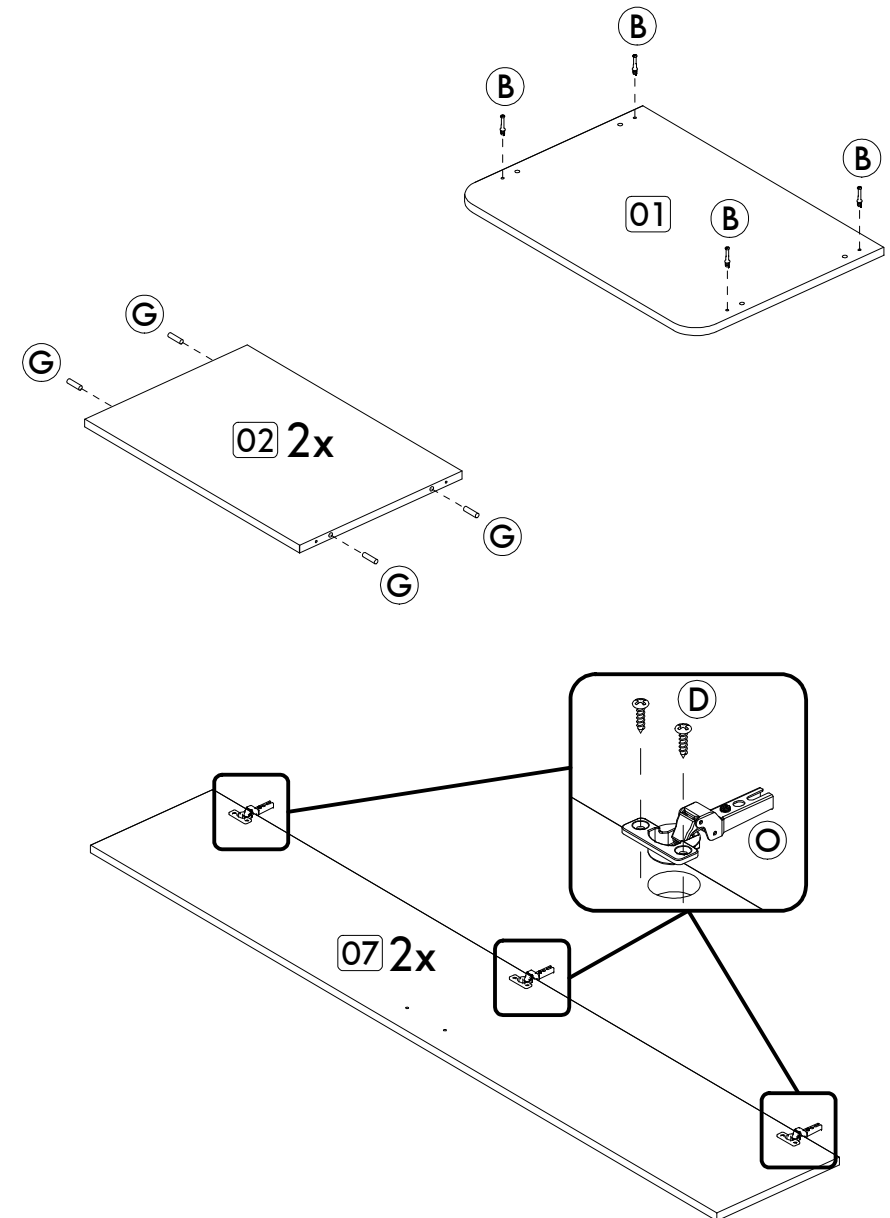

Passo / Step / Paso 01

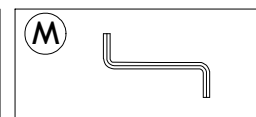
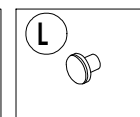
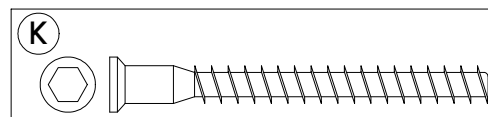
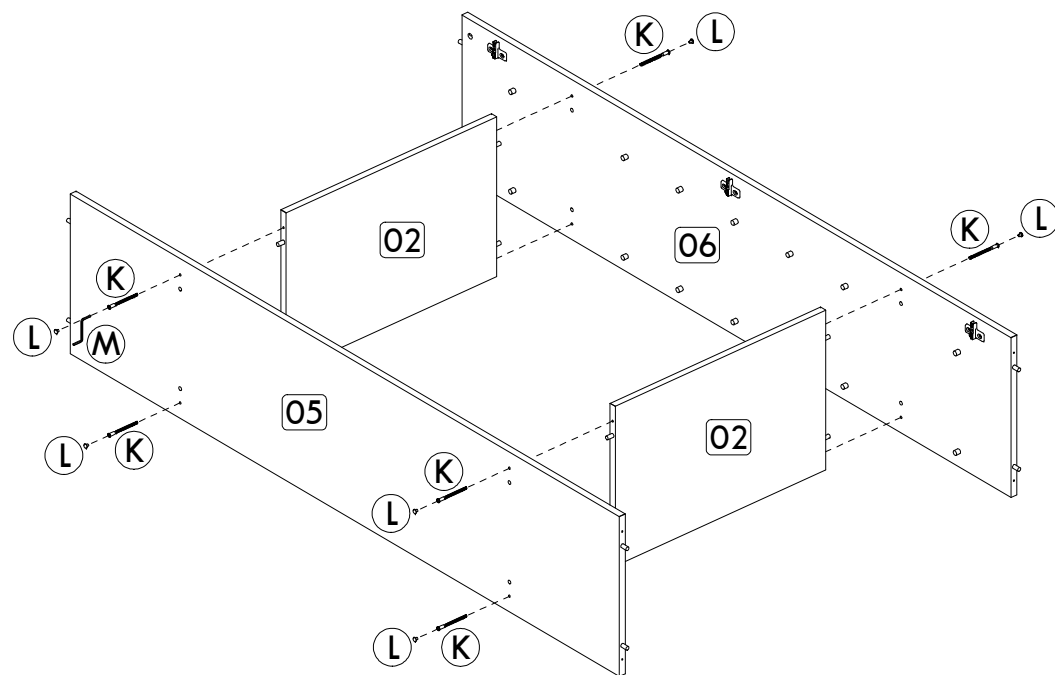
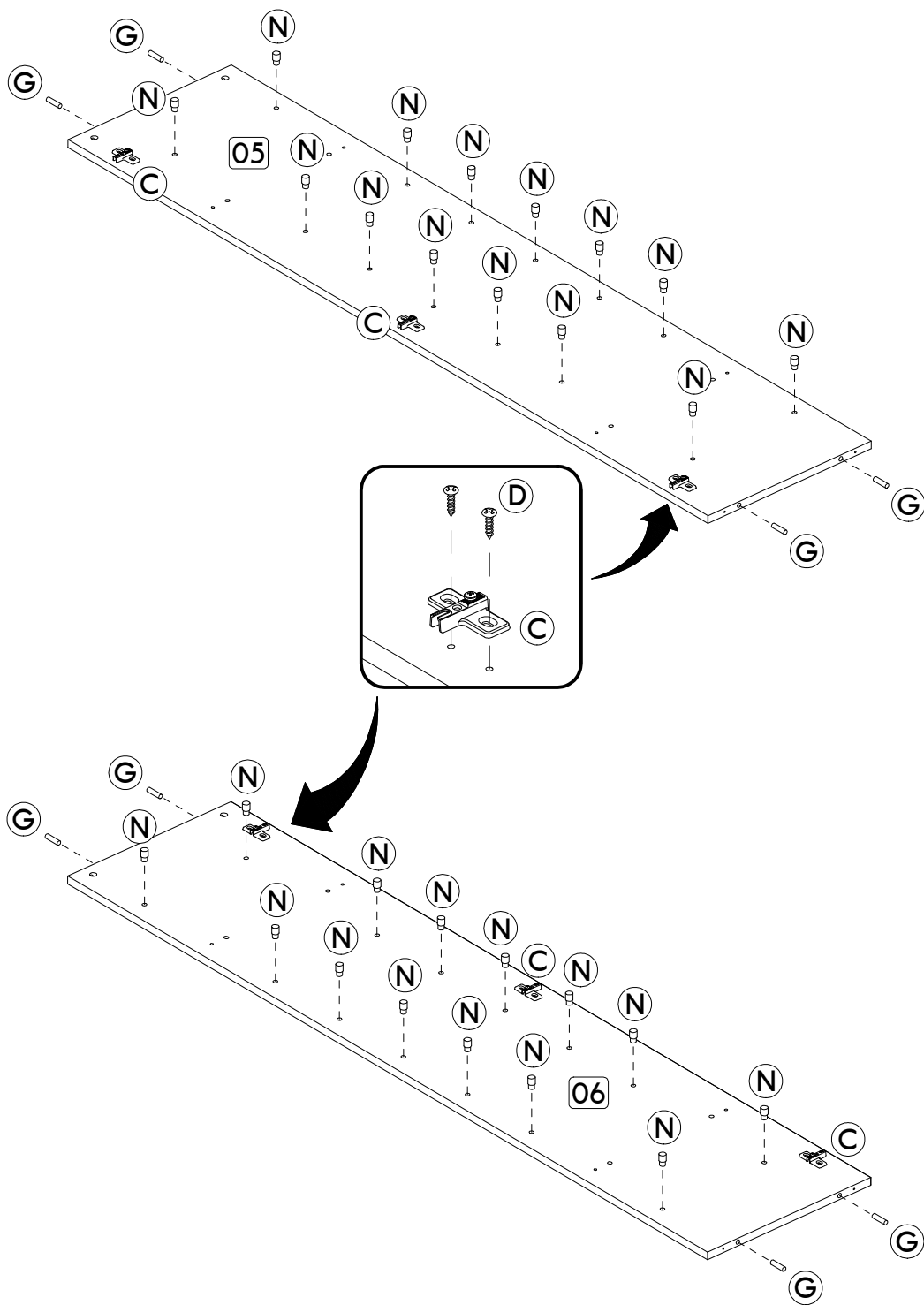

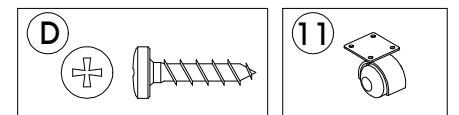
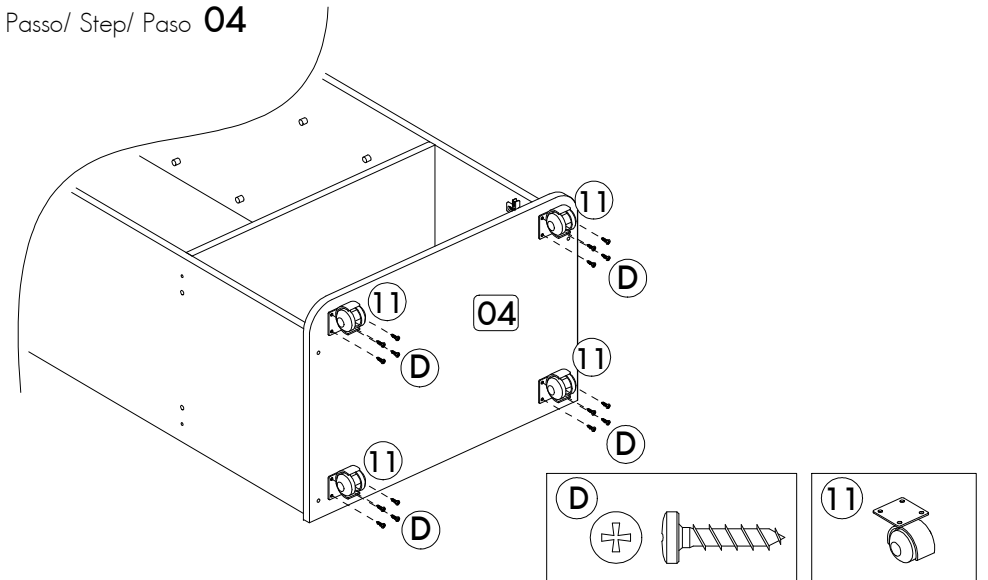
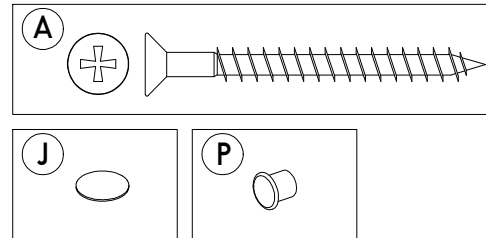
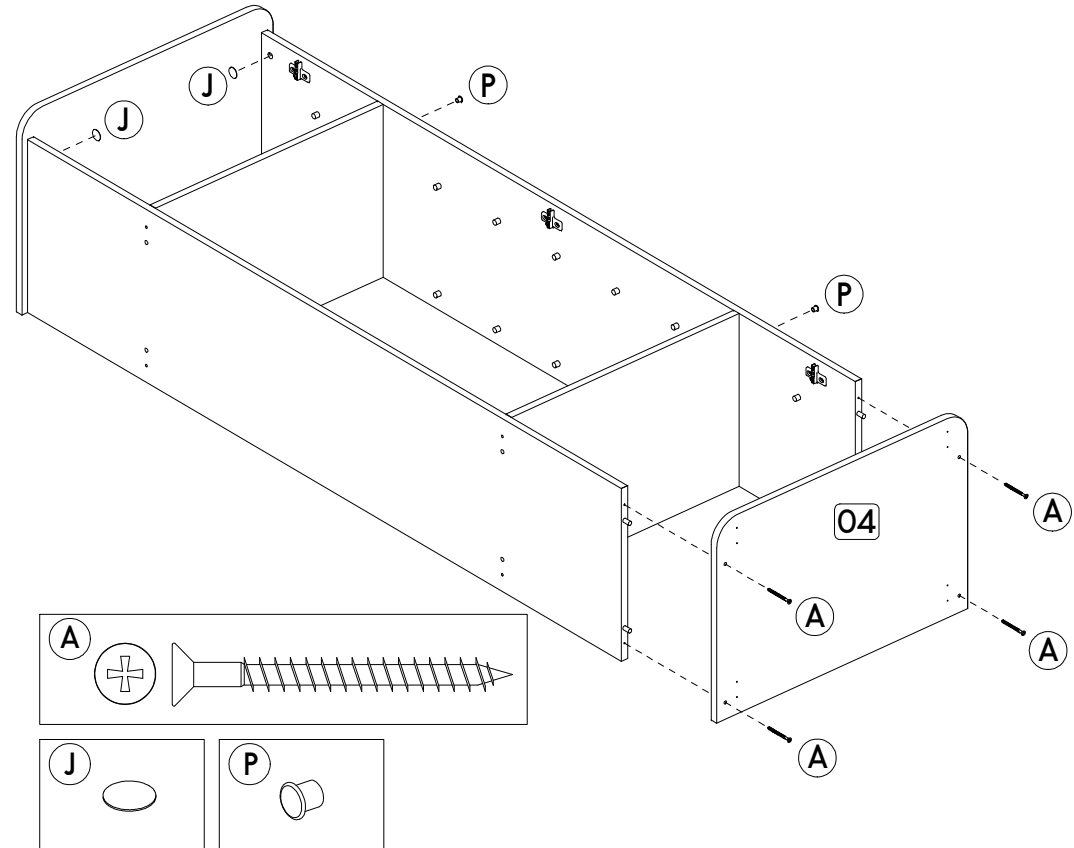
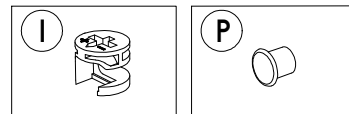
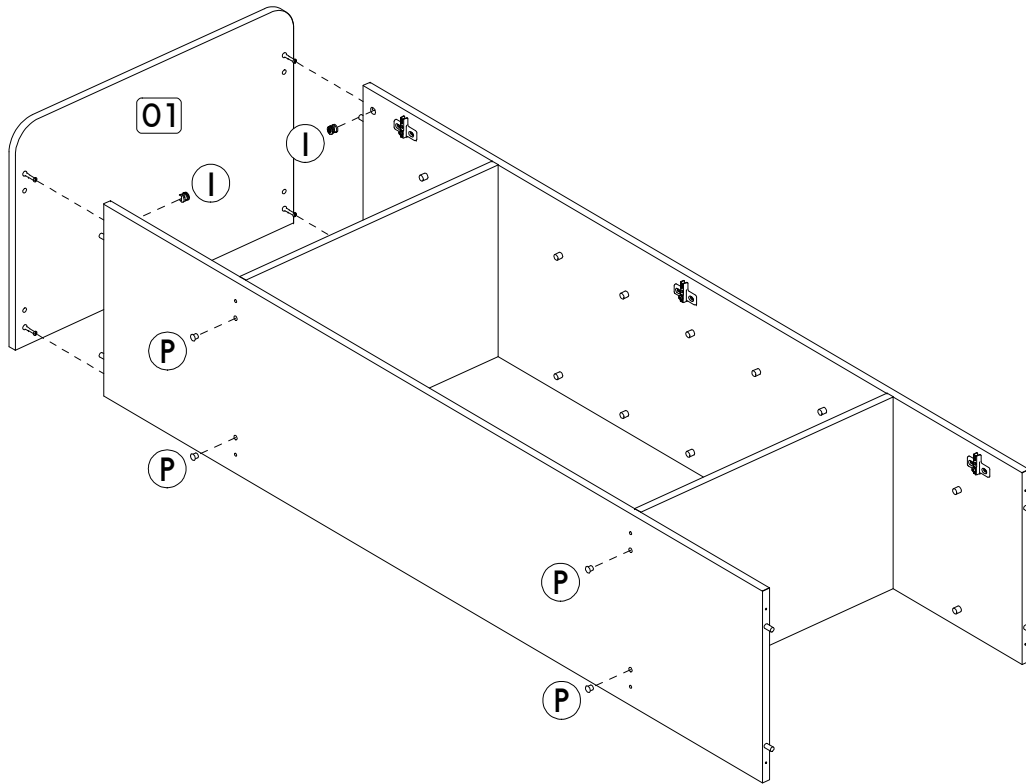
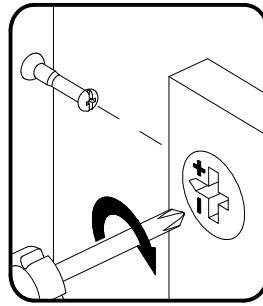

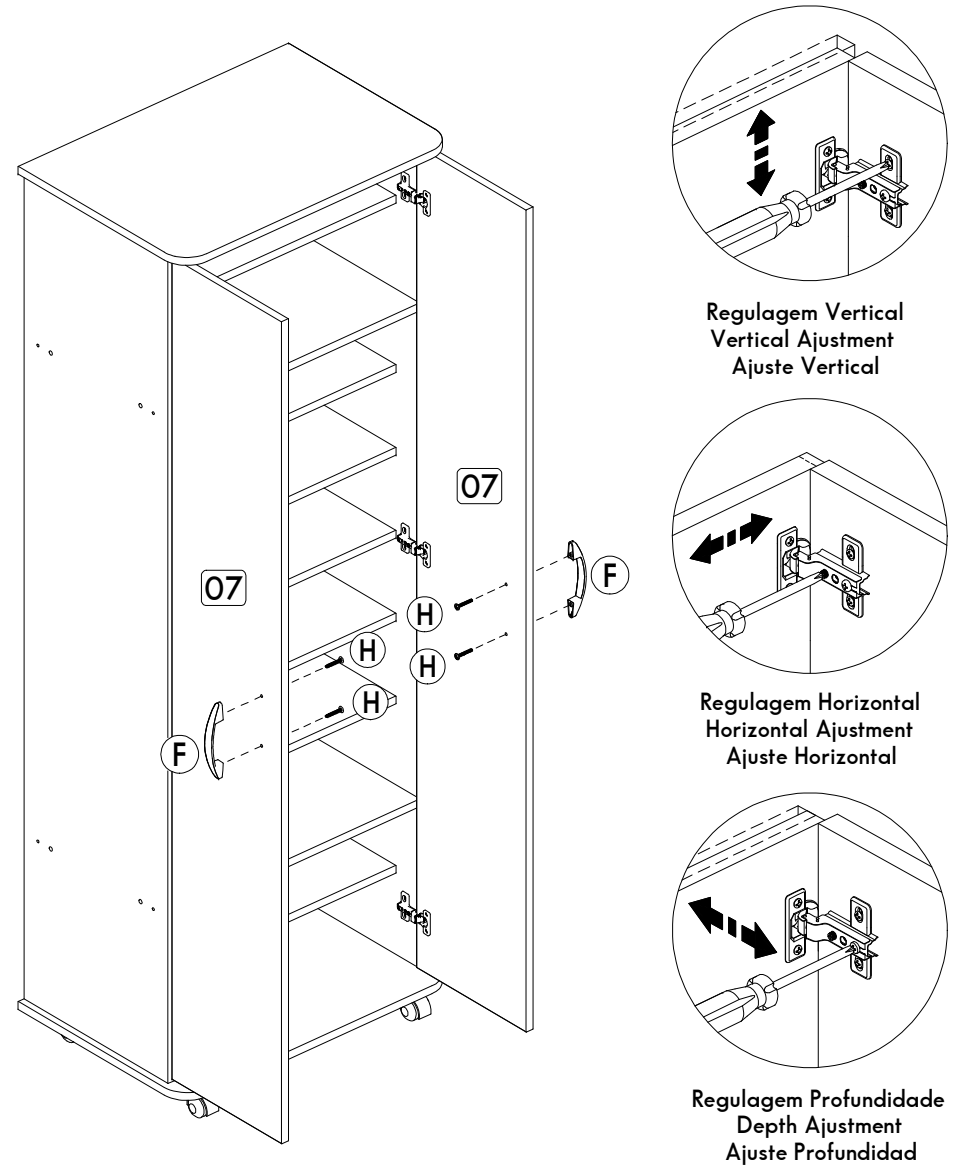
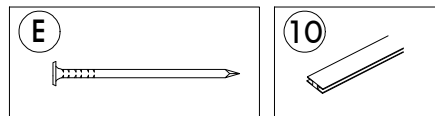
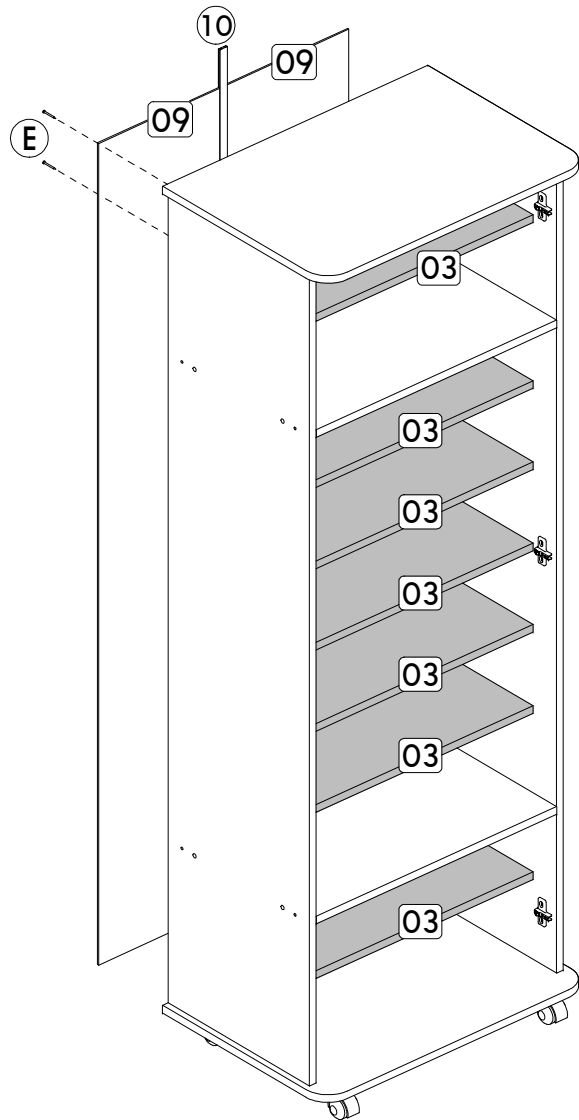

Regulagem Vertical
Vertical Adjustment
Ajuste Vertical

Regulagem Horizontal
Horizontal Adjustment
Ajuste Horizontal

Regulagem Profundidade
Depth Adjustment
Ajuste Profundidad

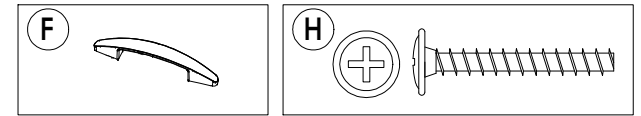

Agora que você já comprou o seu móvel, ele merece ser montado do jeito certo.

Erros de montagem causam mais de **60%** dos danos em móveis.

Por que **contratar?**

Tranquilidade do **início ao fim** da montagem



PROFISSIONAIS QUALIFICADOS

Especialistas certificados na **MadeiraMadeira Serviços**.



FERRAMENTAS PROFISSIONAIS

que **protegem** seus móveis.



AGENDAMENTO EM 24 HORAS

escolha a data e o turno **ideais para** você.



GARANTIA DE 3 MESES

de cobertura **completa**.

Mais de 1 MILHÃO DE MONTAGENS
★ com avaliação **4.7** ★

Mariana S., São Paulo

"Chegaram no horário e montaram tudo rapidamente. Serviço incrível!"



Carlos R., Belo Horizonte

"Tentei montar sozinho e foi um desastre. Com a **MadeiraMadeira Serviços** ficou perfeito."



Ana P., Rio de Janeiro

"Agendamento ágil e **montagem pontual e perfeita**. Recomendo demais!"



Agende agora pelo
QR Code

Madeira**Madeira** Serviços · Atendimento em todo o Brasil



Escaneie o QRCode