

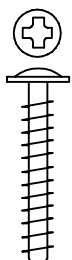

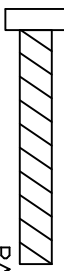









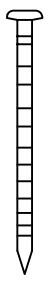

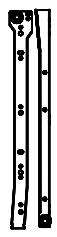



LEGENDA

COD. ASSISTENCIA	PEÇAS	QTD	COMPR	LARG	ESPES
23160	FRENTE DE GAVETA MENOR	01	515mm	130mm	15mm
23161	FRENTE DE GAVETA MAIOR	02	515mm	188mm	15mm
23162	LATERAL DIREITA	01	573mm	448mm	15mm
23163	LATERAL ESQUERDA	01	573mm	448mm	15mm
23164	TAMPO	01	537mm	448mm	15mm
23165	RDDAPE FRONTAL	01	505mm	60mm	15mm
23166	LATERAL DE GAVETA DIREITA MENOR	01	420mm	80mm	15mm
23167	LATERAL DE GAVETA ESQUERDA MENOR	01	420mm	80mm	15mm
23168	CABECEIRA DE GAVETA MENOR	01	450mm	80mm	15mm
23169	LATERAL DE GAVETA MAIOR	04	420mm	120mm	15mm
23170	CABECEIRA DE GAVETA MAIOR	02	450mm	120mm	15mm
23171	COSTA	01	525mm	460mm	3mm
23172	FUNDDO DE GAVETA	03	463mm	418mm	3mm

	Cód.	FERRAGEM	QTD.
A	2592	 PARAFUSO ZINCADO BRANCO 4,0X40	06
B	10571	 PARAFUSO M4X42	06
C	4214	 PARAFUSO 3,5X14 CHATO	61
D	491	 PARAFUSO CHATO 4,0X25	04
E	107	 PREGOS 10X10	38
F	149	 PREGOS 13X15	05
G	1901	 SAPATA DESLIZADORA PRETA 15X6	04
H	169	 CORREDIÇA METÁLICA 400MM	03
I	1802	 CAVILHA 6X30MM	36

J	41	 COLA BRANCA	01
K	85	 "L" DE METAL	16
L	58	 Kappesberg ^{móveis}	01
M	10276	 PUXADOR DE METAL 10X10 CROMADO 300MM	03
N	10307	 PAR TUBINHO P/ PUXADOR	03
□	10306	 PAR PONTEIRA CROMADA 10X10	03
P	14720	 TAPA ADESIVO CARVALLE ASC, CAR, ND= CARVALLE	04
P	8010	 TAPA ADESIVO BRANCO BR= BRANCO	04
P	40736	 ADESIVO TAPA PARAFUSO NDGAL ND= NDGAL	04
		 SACO PEQUENO PARA ACESSÓRIO	01

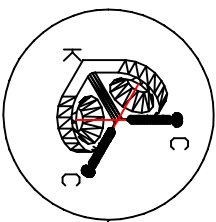

"L" DE ZAMAG PARA
PRENDER A FRENTE
DE GAVETA

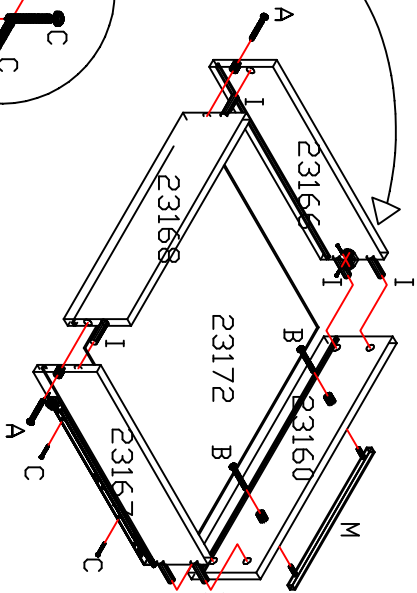

PARA UNIR UM MOVEL NO OUTRO
USAR O PARAFUSO "D"

"Obs: Colocar os
parafusos da
corrediga pelo lado
e não por baixo."

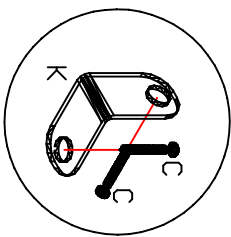

USAR O "L" DE ZAMAG
PARA FIXAR O TAMPO
NAS LATERAIS E SEU
RODAPE FRONTAL FIXANDO
COM O PARAFUSO "C"

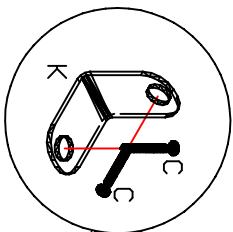
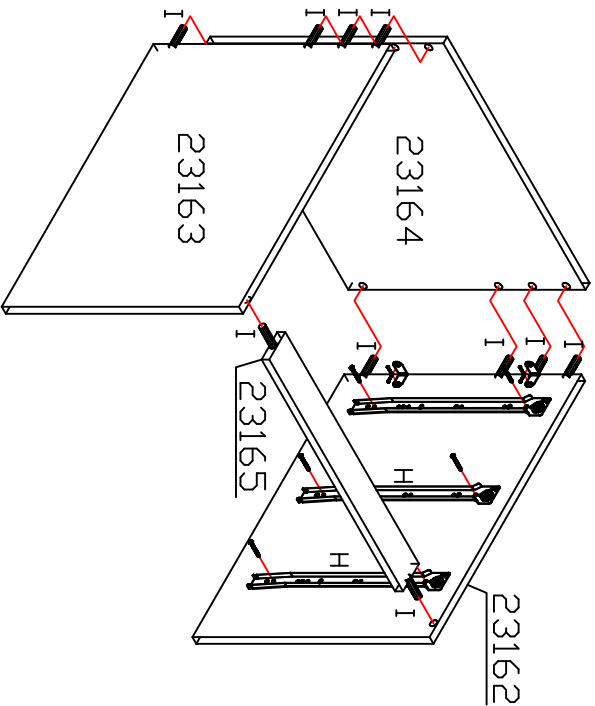

"L" DE METAL PARA
PRENDER A FRENTE
DE GAVETA

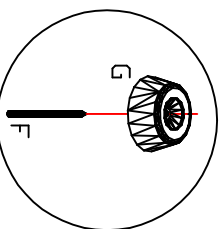

SAPATA

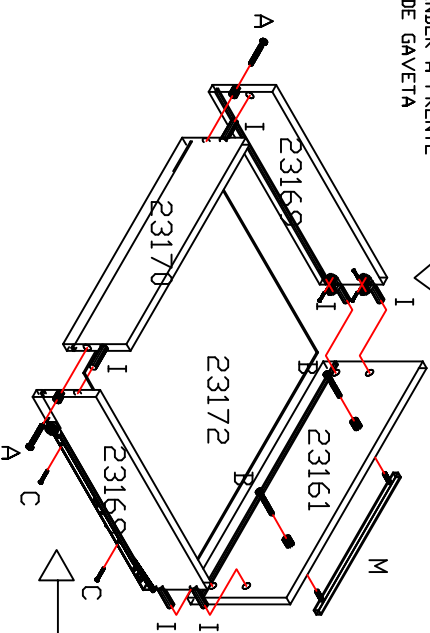

FIXADOR DE COSTA

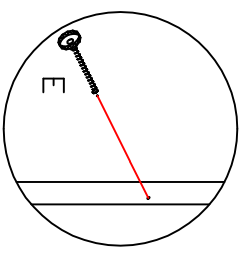

"Obs: Colocar os
parafusos da
corrediga pelo lado
e não por baixo."

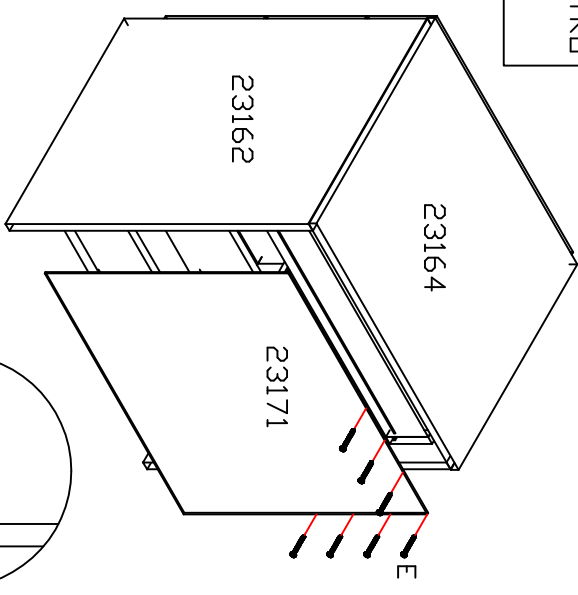

Kappesberg

Rua Emancipação 2000- Tupandi-RS
Fone: (51) 3635-8800
www.kappesberg.com.br

A2203

GARANTIA POR DEFEITOS DE
FABRICAÇÃO DE 03 MESES.

