

BF - 3206



Instruções de Montagem Assembly Instructions Instrucciones de Armado

Accesse Vídeos de Montagens
Access Mounting Videos
Acceder a los Vídeos de Montaje
www.tecnomobili.ind.br

tecnomobili
Estrada RSC 453, Km s/n° | Garibaldi | RS
CEP: 95720-000 | Fone / Fax: 54.3464.2050
sac@moveisvideira.com.br

Notas Especiais:

- 01** -Examine completamente todas as peças do móvel antes de começar o trabalho.
- 02** -Recomenda-se montar o móvel conforme este Manual de Montagem.
- 03** -É de responsabilidade do montador seguir as instruções do Manual de Montagem, que são fundamentais para garantir a estrutura do móvel.
- 04** -Para limpeza, utilizar somente pano úmido e sabão neutro.

Special notes:

- 01** -Check all parts of the unit thoroughly before starting work.
- 02** -It is recommended to assemble the furniture according to this Installation Manual.
- 03** -It is the responsibility of the assembler to follow the instructions in the Assembly Manual, which are essential to ensure the structure of the furniture.
- 04** -For cleaning use only damp cloth and neutral soap.

Notas especiales:

- 01** -Examine completamente todas las piezas del mueble antes de iniciar el trabajo.
- 02** -Se recomienda montar el mueble conforme el Manual de Ensamblaje.
- 03** -Es de responsabilidad del montador seguir las instrucciones del Manual de Ensamblaje, que son fundamentales para garantizar la estructura del mueble.
- 04** -Para limpieza solamente usar trapo húmedo y jabón neutro.





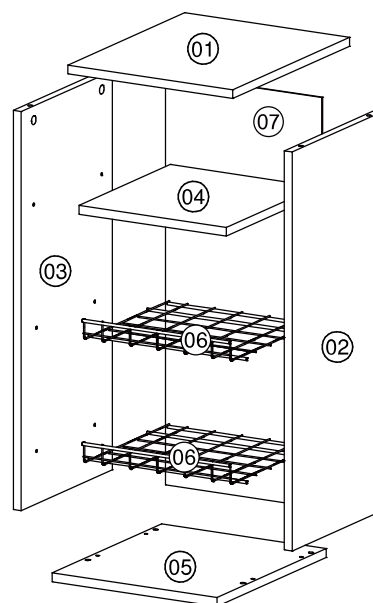

Guarante certificate:

The guarantee of products manufactured by Móveis Videira LTDA covers any defects / manufacturing defects, within the period established by the Consumer Protection Code, in its Article 26, II, which provides for a legal guarantee of ninety (90) days.

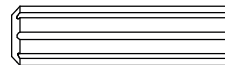
Lista de Peças / List of pieces / Lista de piezas

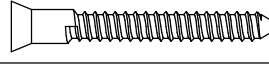
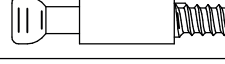
CóD	DESCRIÇÃO	DESCRIPTION	DESCRIPCION	QTD	RAW MATERIAL	DIMENSION	CÓD
01	Tampo	Top	Tapa	1	MDP 15mm	313x385x15	703206
02	Lateral Direita	Right Side	Lateral Derecha	1	MDP 15mm	680x300x15	303206
03	Lateral Esquerda	Left Side	Lateral Izquierda	1	MDP 15mm	680x300x15	313206
04	Prateleira	Shelf	Estante	1	MDP 15mm	280x300x15	213206
05	Base	Base	Base	1	MDP 15mm	313x360x15	103206
06	Cesto	Basket	Cesto	2		280x285x39	
07	Costa	Back	Revés	1	Capa Dura 3mm	700x297x3	433300

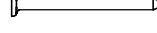

REF	DESCRIPTION	QTD	CÓD
A	 8x30mm	04	2806
B	 3,5x40mm CC	04	8115
C	 5,0x40mm CC	04	4000
D	 34x7mm Parafuso minifix	04	3771
E	 15x12mm Tambor minifix	04	9516
F	 Suporte para Prateleira 5x8 c/ Estria 14x8x5mm	04	3748
G	 50x40mm Sapata	04	3787
H	 22x3mm	16	3051

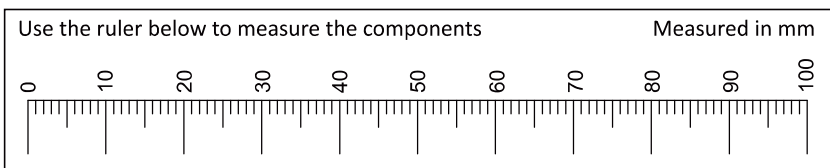

Review: 04
Date: 05/04/2023

Ferramentas | Tools | Herramientas

