

INSTRUÇÃO DE MONTAGEM

INSTRUCCIONES DE MONTAJE

ASSEMBLY INSTRUCTIONS

Criado Mudo 1 Porta 03 Gavetas Diamante
Mesilla de Noche 1 Puerta 03 Cajones Diamante
Bedside Table 1 Door 03 drawers Diamond

Referência/Cor

- M315-26 - Fendi/Branco HP
- M315-83 - Moka
- M315-85 - Moka/Fendi

Requisitos para montagem

Requisitor para la montaje
 Assembly Requirements

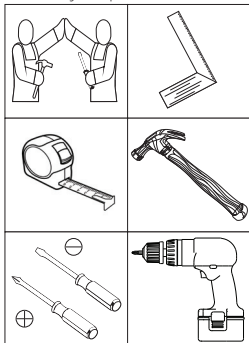

Imagens meramente ilustrativas
 Imágenes meramente ilustrativas
 Images for illustration only

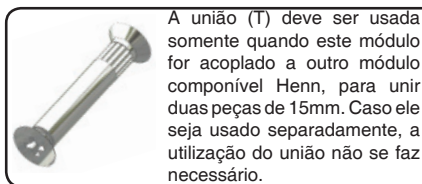

A união (T) deve ser usada somente quando este módulo for acoplado a outro módulo componível Henn, para unir duas peças de 15mm. Caso ele seja usado separadamente, a utilização do união não se faz necessário.

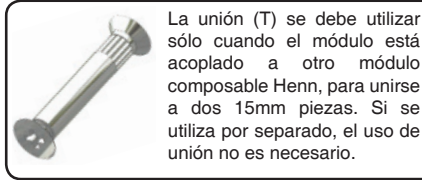

La unión (T) se debe utilizar sólo cuando el módulo está acoplado a otro módulo composable Henn, para unirse a dos 15mm piezas. Si se utiliza por separado, el uso de unión no es necesario.

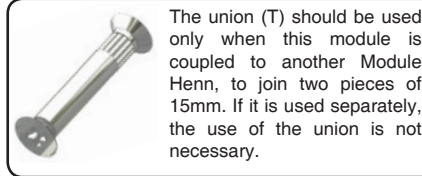

The union (T) should be used only when this module is coupled to another Module Henn, to join two pieces of 15mm. If it is used separately, the use of the union is not necessary.

Option 1

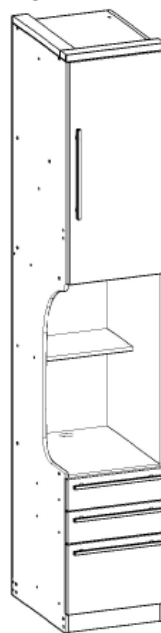

Option 2

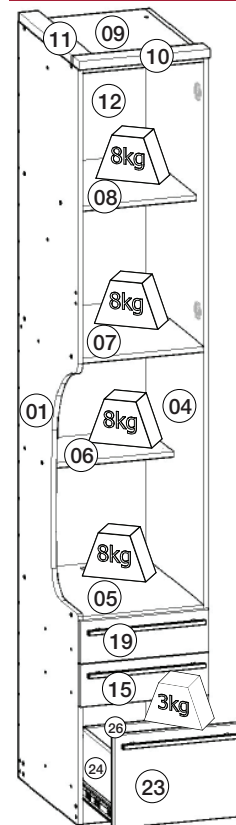
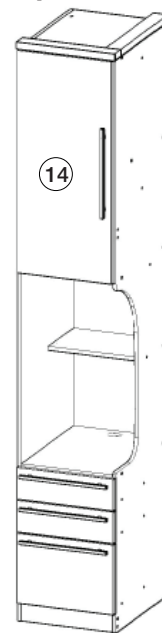

Pesos máximos recomendados com carga uniformemente distribuídas.
 Peso máximo recomendado con la carga distribuida uniformemente.
 Recommended maximum weights with evenly distributed.

Lista de Peças / Lista de piezas / List of parts

Item	Caixa Box	Qtd Qty	Descrição/ Descripción	Medidas (mm) / Dimensions (mm) / Size (measurements) (mm)
01	1/1	01	Lateral esquerda Lateral izquierda Left side	2275x520x15
02	1/1	01	Rodapé frontal Pie delantero Front baseboard	370x73x15
03	1/1	01	Rodapé traseiro Pie trasero Rear baseboard	370x73x15
04	1/1	01	Lateral direita Lateral derecha Right side	2275x520x15
05	1/1	01	Tampo das gavetas Cubierta del cajón Drawer Top	520x370x15
06	1/1	01	Prateleira central Estante central Central shelf	370x250x15
07	1/1	01	Prateleira Estante Shelf	520x370x15
08	1/1	01	Prateleira menor Estante menos Small shelf	450x370x15
09	1/1	01	Tampo Tapa Top	520x370x15
10	1/1	01	Moldura Frontal Marco frontal Front frame	400x60x25
11	1/1	01	Moldura lateral Marco lateral Side frame	475x60x25
12	1/1	01	Fundo Fondo Bottom	1655x390x3
13	1/1	01	Fundo cru Fondo sin procesar Raw background	552x390x3
14	1/1	01	Porta criado Puerto creado Created port	885x385x15
15	1/1	01	Frente de gaveta Frente de cajón Front of drawer	385x127x15
16=20	1/1	02	Lado de gaveta Lado del cajón Side of drawer	350x90x15
17=21=25	1/1	01	Fundo de gaveta Fondo del cajón Drawer bottom	361x326x3
18=22	1/1	01	Ripa de trás Malla detrás Rear lath	345x90x15
19	1/1	01	Frente de gaveta superior Frente de cajón superior top drawer front	385x127x15
20=16	1/1	02	Lado de gaveta Lado del cajón Side of drawer	350x90x15
21=17=25	1/1	01	Fundo de gaveta Fondo del cajón Drawer bottom	361x326x3
22=22	1/1	01	Ripa de trás Malla detrás Rear lath	345x90x15
23	1/1	04	Frente de gaveta maior Frente de cajón mayor Largest drawer front	385x279x15
24	1/1	02	Lado de gaveta maior Lado del cajón mayor Largest drawer side	350x180x15
25=17=21	1/1	01	Fundo de gaveta Fondo del cajón Drawer bottom	361x326x3
26	1/1	01	Ripa de trás maior Malla detrás mayor Larger rear lath	345x180x15

AVISO
 Para limpeza de seu móvel, use uma flanela seca ou umedecida, e não utilize produtos químicos que possam danificar seu produto.

SISTEMA DE MONTAGEM
 O sistema de montagem dos produtos, funciona de acordo com a ordem crescente dos números indicados no desenho. Ex: 01, 02, 03, 04... até a conclusão da montagem.

ADVERTENCIA
 Para limpieza de su móvil, use una flanela seca o húmeda, y no utilice productos químicos que puedan dañar su producto.

SISTEMA DE MONTAJE
 El sistema de montaje de los productos funciona de acuerdo con el orden creciente de los números indicados en el dibujo. Ej.: 01, 02, 03, 04... hasta la conclusión del montaje.

NOTICE
 To clean your furniture, use a dry or wet cloth, and do not use chemicals that may damage your product.

ASSEMBLY SYSTEM
 The products' assembly system works according to the increasing order of the indicated numbers. For example: 01, 02, 03, 04 ... to the end of the assembly.

Ferragens | Herrajes | Hardware

A 04x Parafuso 4,5x50mm CHT. Tornillo 4,5x50mm CHT. Screw 4,5x50mm CHT.	B 04x Parafuso 4,0x35mm CHT. Tornillo 4,0x35mm CHT. Screw 4,0x35mm CHT.	C 20x Parafuso 3,5x40mm CHT. Tornillo 3,5x40mm CHT. Screw 3,5x40mm CHT.	D 08x Parafuso 3,5x40mm FLA. Tornillo 3,5x40mm FLA. Screw 3,5x40mm FLA.	E 08x Parafuso 3,5x14mm FLA. Tornillo 3,5x14mm FLA. Screw 3,5x14mm FLA.	F 08x Parafuso 3,5x12mm CHT. Tornillo 3,5x12mm CHT. Screw 3,5x12mm CHT.	G 52x Cavilha 8x25mm Cinta 8x25mm Dowel 8x25mm	H 08x Cantoneira plástica Cantонера plástica Plastic angle brackets
I 04x Fixador de Fundos Fund Fixer Bottom fixer	J 12x Prego 12x12mm Anilado Clavo 12x12mm Anilado Ringed Nail 12x12mm	K 56x Prego 10x10mm Clavo 10x10mm Nail 10x10mm	L 04x Porca cilíndrica Tuerca cilíndrica Cylindrical nut	M 04x Sapata "L" 15x15mm Zapata "L" 15x15mm "L" shoe 15x15mm	N 03x Corrediza telescópica Diapositivas telescópicas Telescopic slides	O 02x Dobradiza metal 26mm Bisagra de metal 26mm 26 mm metal hinge	P 02x Calço metal 5mm Calzado metálico 5mm 5 mm metal shim
Q 04x Puxador Alumínio 323mm Tirador Alumínio 323mm Handle Aluminum 323mm	R 02x Sachê de cola Bolsa de pegamento Glue bag	S 47x Adesivo tapa parafuso 10mm Adhesivo tapon de tornillo 10mm Bolt cover adhesive 10mm	T 05x Parafuso União Metal Tornillo Unión Metal Metal Union Screw				

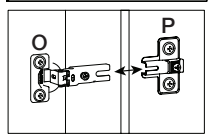
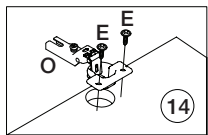
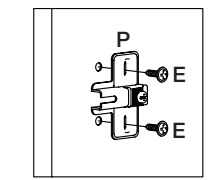
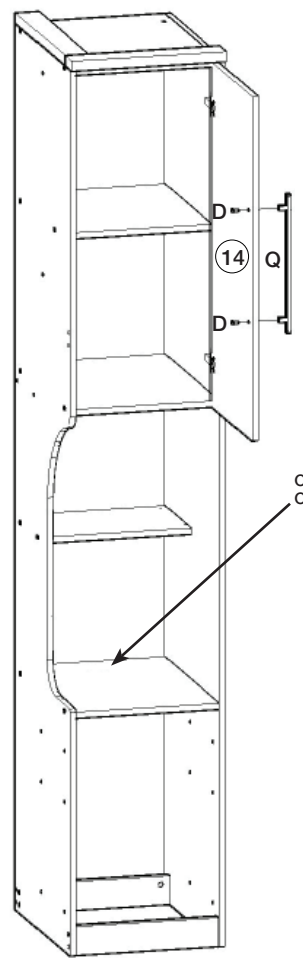
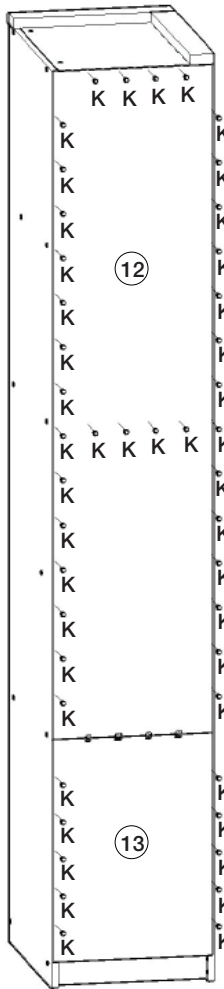
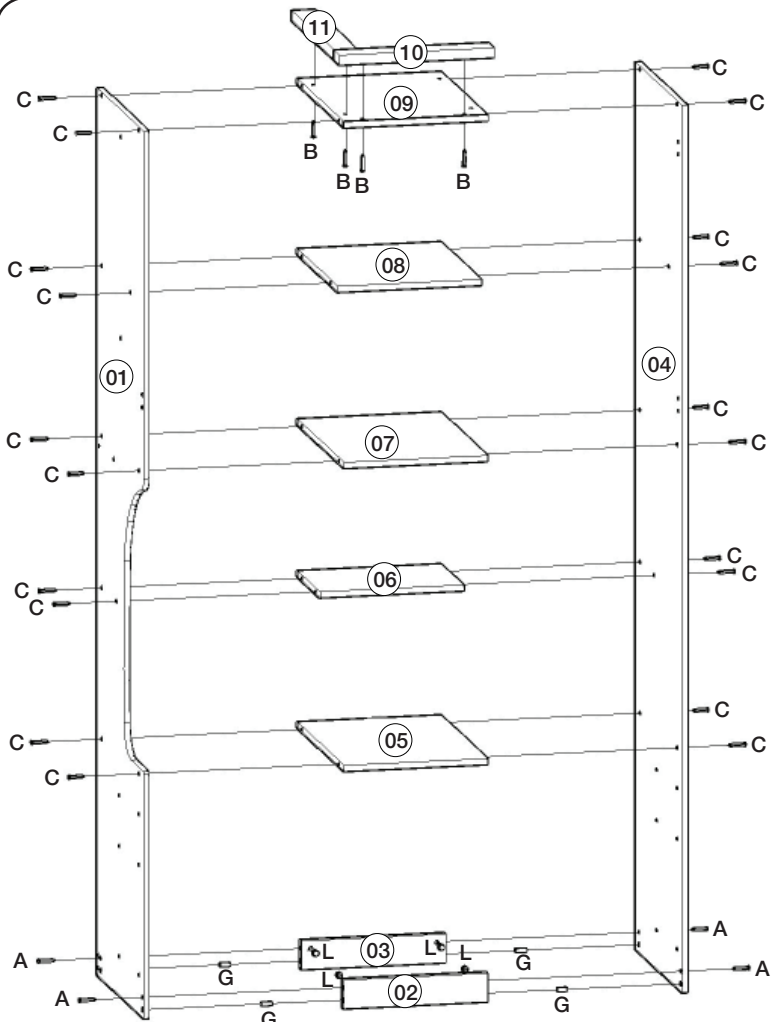

OPCIONAL: Kit Tomada Preta
 OPTIONAL: Kit socket Black

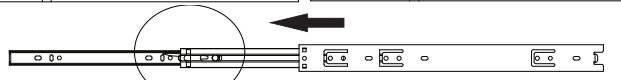
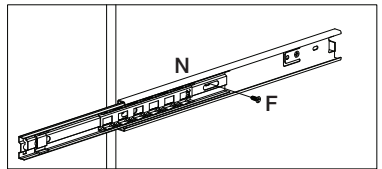
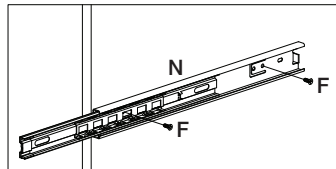
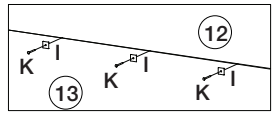
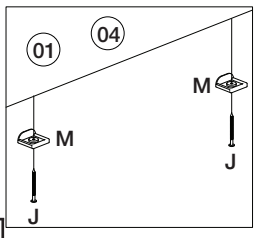

Para a desmontagem da correia siga a instrução ao lado.
 For the dismount of the sliding one, follows the instruction aside.

Para el desmontaje seguimiento de diapositivas la instrucción siguiente a.

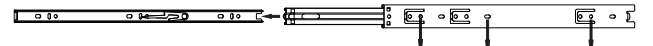
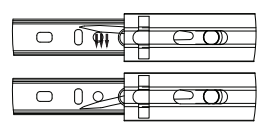

Fixar as correias nessas furações
 Fijar las diapositivas de estos agujeros
 Fix slides in these drillings.

Montagem gaveta / Montaje cajón / Mounting drawer

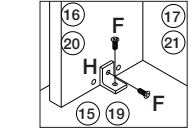
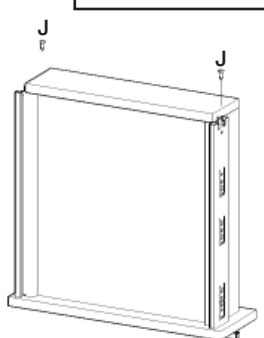
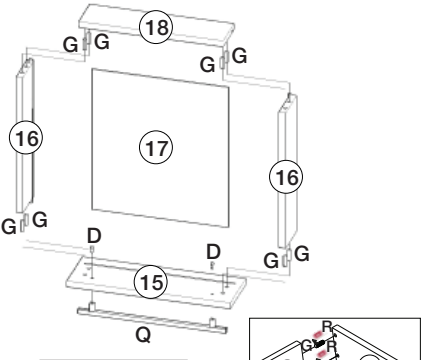

Utilize o sachê de cola (R) nas cavilhas (G) e nos frisos da gaveta.
 Utilice pegamento sobre (R) los pernos (G) y cajón de friso.
 Use the glue sachet (R) in the pins (G) and in the ledges of the drawers.

Montagem gaveta superior / Montaje cajón superior / Mounting top drawer

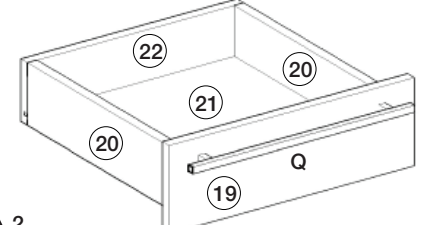

A correia (N) deverá ser alinhada com a parte de baixo do lado de gaveta (16 e 20)
 La corredera (N) debe ser alineada con la parte de por el lado del cajón (16 y 20)
 The slide (N) should be Aligned with the bottom Of the drawer side (16 and 20)

Montagem gaveta maior / Montaje cajón mayor / Larger drawer assembly

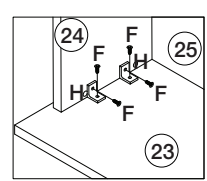
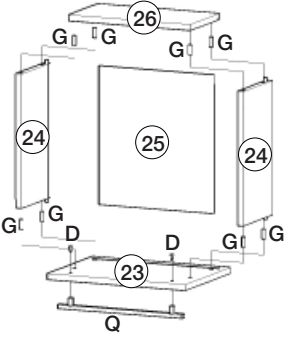

A correia (N) deverá ser alinhada com a parte de baixo do lado de gaveta (24)
 La corredera (N) debe ser alineada con la parte de por el lado del cajón (24)
 The slide (N) should be Aligned with the bottom Of the drawer side (24)

