



MÓVEIS  
**Novo  
HORIZONTE**

[www.moveisnovohorizonte.com.br](http://www.moveisnovohorizonte.com.br)

## ROUPEIRO THOR GOLD

ALT.: 2350mm | LARG.: 1841mm | PROF.: 555mm



**CURTA NOSSA PÁGINA  
NO FACEBOOK  
LINK AO LADO (QR CODE)**



### FICHA TÉCNICA

PRODUTO 100% MDF  
ESPELHO PORTA (OPCIONAL)  
BATENTE PORTA EM BRONZE  
TRILHO INFERIOR EM BRONZE  
CORREDIÇAS TELESCÓPICAS  
CALCEIROS E CABIDEIROS EM ALUMÍNIO  
ACABAMENTO EM ALTO BRILHO ULTRAVIOLETA E HD

**PARA ASSISTÊNCIA TÉCNICA, INDICAR NOME,  
CÓDIGO E COR DA PEÇA.**

**PARA SOLICITAR FERRAGENS, UTILIZE A  
LISTA DA PÁGINA 2.**

## RELAÇÃO DAS PEÇAS E IDENTIFICAÇÃO DOS VOLUMES

Nº Peça	Código	Volume 1/4 - 10187 LATERAL THOR GOLD	Qt.
15	8283	DISTANCIADOR DIANTEIRO	02
16	8284	DISTANCIADOR TRASEIRO	02
10	8178	DIVISÃO ESQUERDA	01
09	7901	DIVISÃO MENOR	01
05	9884	LATERAL DIREITA	01
07	9883	LATERAL ESQUERDA	01
12	10249	MOLDURA LATERAL	02
11	8040	PRATELEIRA MALEIRO	02
24	7904	PRATELEIRA PEQUENA	02
03	6866	TRAVESSA RODAPÉ	01
R1	9958	BATENTE ALUMÍNIO 2145 BRONZE	02
F7	5357	CORREÇÃO TELESCÓPICA 350mm	03
	10193	KIT FERRAGEM	01
L5	10169	PERFIL PUXADOR BRONZE 2145mm	02
21	3710	LATERAL GAVETA	06

Nº Peça	Código	Volume 2/4 - 10186 TAMPO THOR GOLD	Qt.
04	9091	BASE	01
17	9093	COSTAS	05
20	7571	FRENTE GAVETA	03
22	7864	FUNDO GAVETA	03
14	10217	MOLDURA SUPERIOR	01
08	7902	PRATELEIRA COLMEIA	01
06	6850	PRATELEIRA GAVETA	01
01	9094	RODAPÉ DIANTEIRO	01
02	9095	RODAPÉ TRASEIRO	01
13	10185	TAMPO	01
23	7572	TRASEIRO GAVETA	03
M4	9363	PERFIL H 1814mm	04
Q6	10059	TRILHO INFERIOR 1785 ALUMÍNIO	01
P7	6992	TRILHO SUPERIOR 1785 PVC	01
N5	7879	TUBO OBLONGO 428	02
N4	6975	TUBO OBLONGO 880	01

Nº Peça	Código	Volume 3/4 - 10170 - PORTAS THOR GOLD	Qt.
19	10299	PORTA	02

Nº Peça	Código	Volume 4/4 OPCIONAL - 9277 KIT ESPELHO	Qt.
R5	9678	ESPELHO 875x710 (1 Unidade)	02
R6	9679	ESPELHO 875x355 (1 Unidade)	02

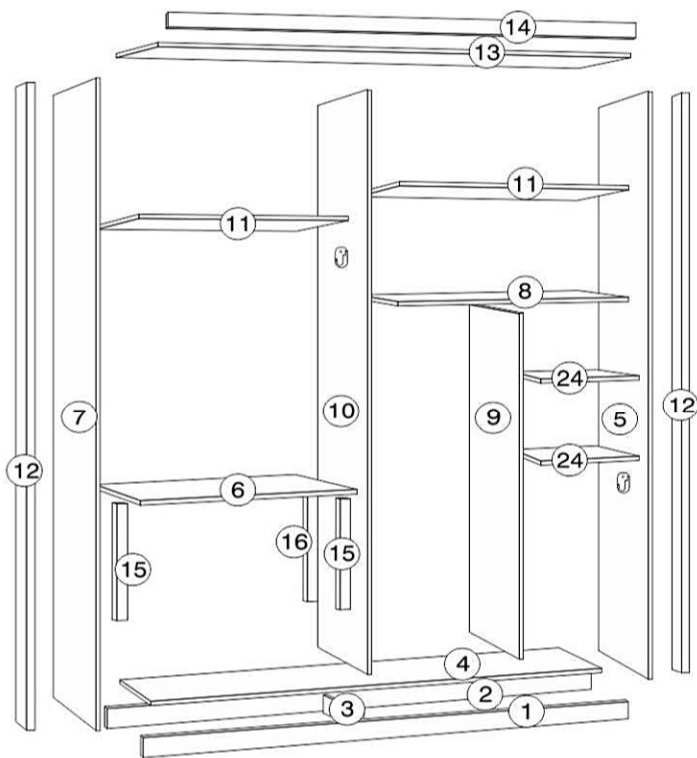

### NECESSÁRIO PARA MONTAGEM



## RELAÇÃO DE FERRAGENS ROUPEIRO THOR GOLD - CÓD. 10193

CÓD.	LETRA	DESENHO	QTD.	NOME
2272	A		38	Parafuso 5,0x40
10323	C2		04	Roldana c/ Rolamento 40mm
1412	C3		04	Guia Superior Duplo
1444	C4		04	Freio Superior
2042	C5		24	Parafuso 3,5x12 Flangeado
1474	C6		100	Prego 10x10
1404	C8		18	Cavilha 6x30
1472	D3		01	Sache de Cola
2043	D4		04	Suporte Angular
4003	D5		08	Suporte Pino Vidro
2051	D7		06	Suporte Cabideiro
2324	D8		06	Conector de Montagem
1453	D9		01	Cantoneira 4 Furos
1117	E2		10	Sapata 15x15
1158	E6		02	Giz
1422	F		22	Parafuso 3,5x35
2040	G		16	Parafuso 3,5x20 Chata
1420	H		85	Parafuso 3,5x14
2859	J		03	Parafuso 3,5x25 Flangeado
1993	J4		03	Puxador Canaã
7514	P		08	Parafuso 3,5x14 Flangeado
3537	Q		08	Parafuso 3,5x16
1459	T		12	Parafuso 6x12
7066	W		08	Parafuso 4x45 Flangeado

## RELAÇÃO DE ACESSÓRIOS ROUPEIRO THOR GOLD

CÓD.	LETRA	DESENHO	QTD.	NOME
5357	F7		03	Correção Telescópica 350mm
10169	L5		02	Perfil Puxador 2145 Bronze
9363	M4		04	Perfil H 1814mm
6975	N4		01	Tubo Oblongo 880mm
7879	N5		02	Tubo Oblongo 428mm
6992	P7		01	Trilho PVC Superior 1785
10059	Q6		01	Trilho Alumínio Inferior 1785
9958	R1		02	Batente Alumínio 2145 Bronze

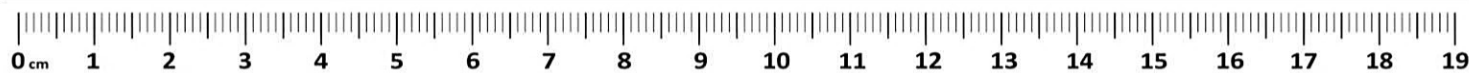

① COMEÇAR A MONTAGEM, EFETUANDO A MONTAGEM DO RODAPÉ CONFORME DESENHO ABAIXO.

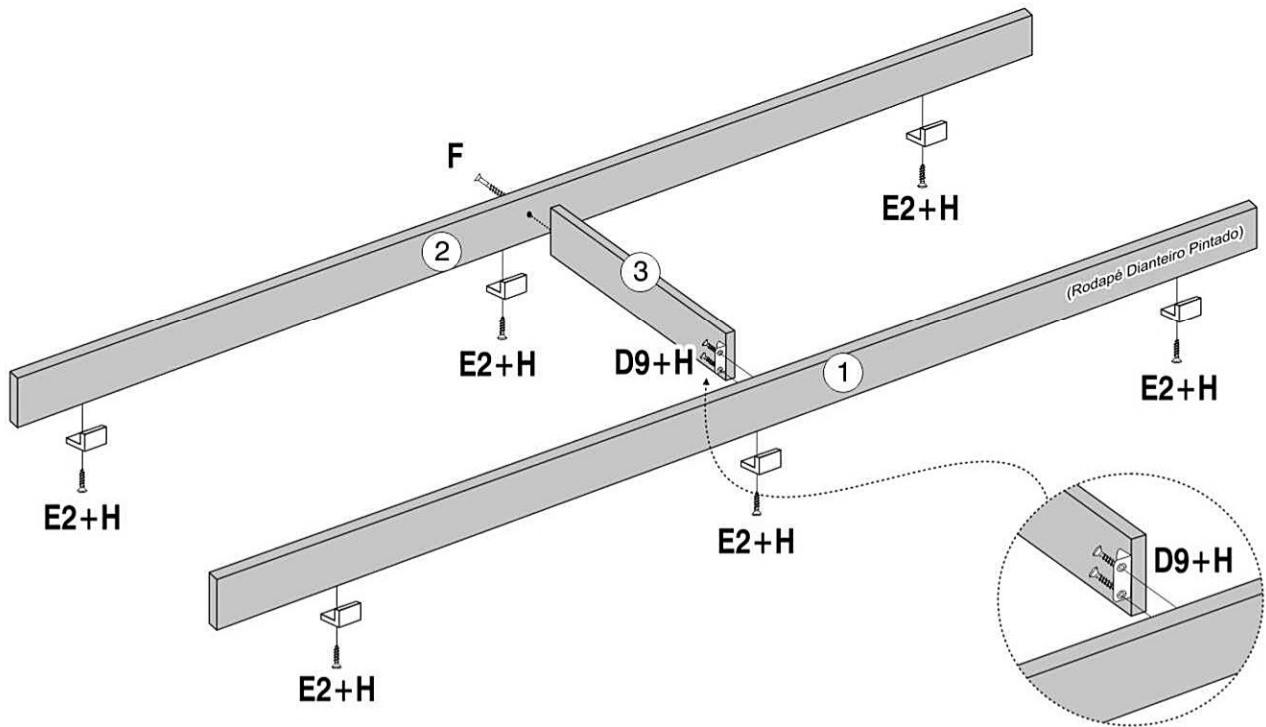

② PARAFUSAR AS LATERAIS NOS RODAPÉS.

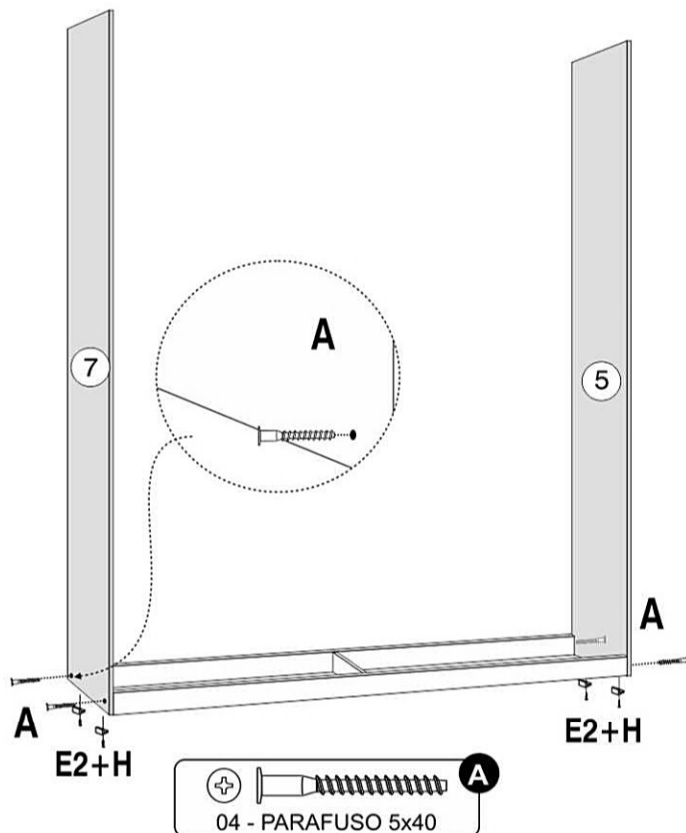

③ PARAFUSAR BASE NOS RODAPÉ E TAMBÉM NAS LATERAIS.

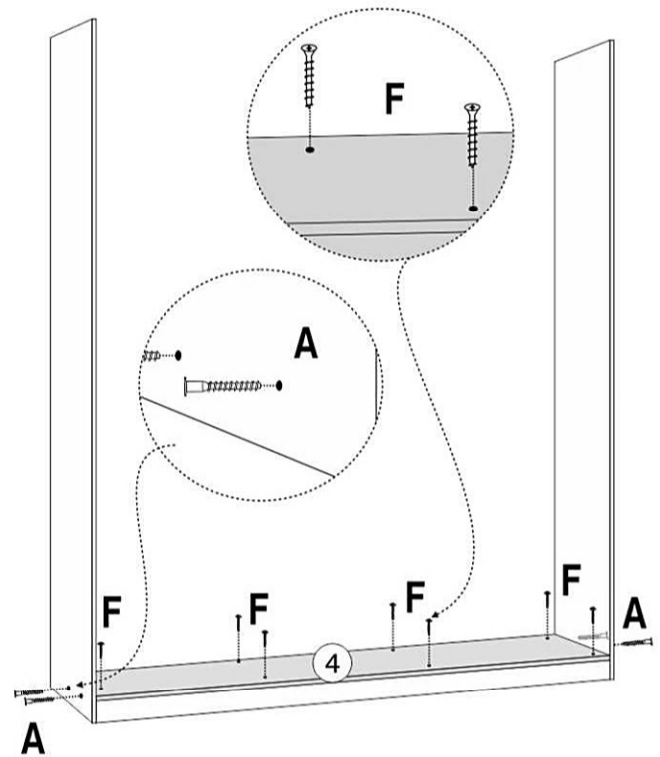

- ④ ENCAIXAR A DIVISÃO, PARAFUSAR A PRATELEIRA NA MESMA E TAMBÉM NA LATERAL ESQUERDA.

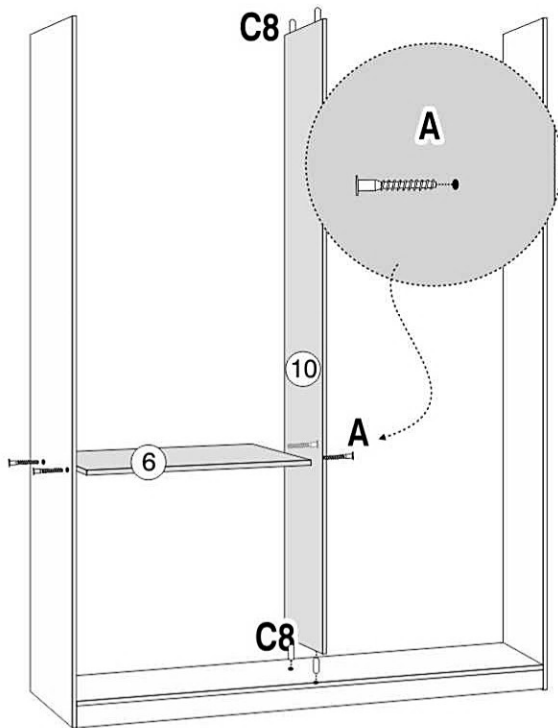

- ⑤ ENCAIXAR A DIVISÃO MENOR E PARAFUSAR A PRATELEIRAS NA MESMA E TAMBÉM NA LATERAL DIREITA.

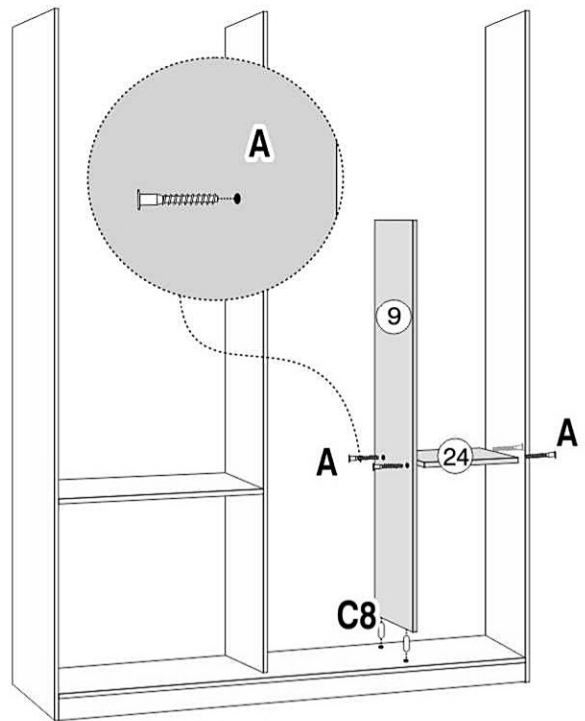

- ⑥ PARAFUSAR A PRATELEIRA NA DIVISÃO E LATERAL DIREITA.

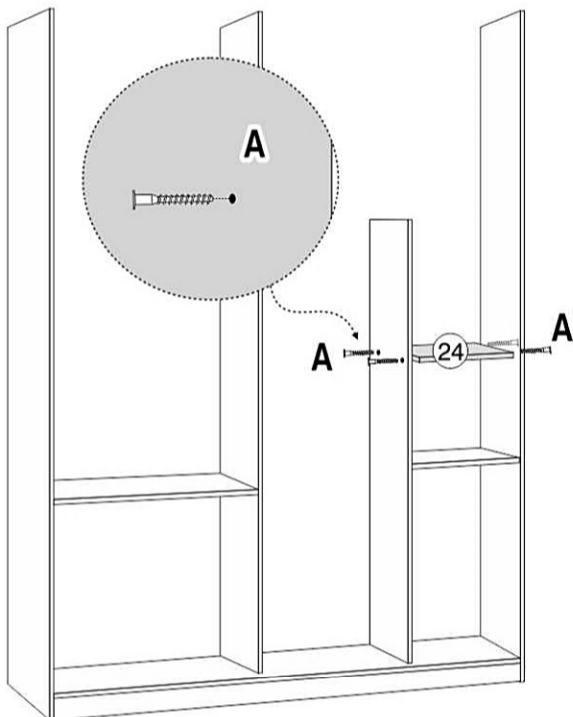

- ⑦ PARAFUSAR A PRATELEIRA NAS DIVISÕES E NA LATERAL DIREITA PARA ESTABILIZAR AS MESMAS.

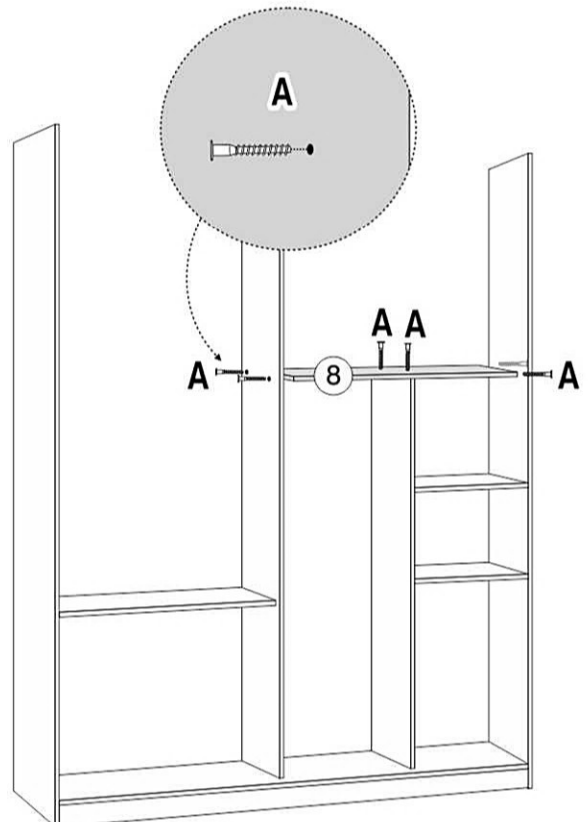

8 PARAFUSAR A PRATELEIRA CENTRAL SUPERIOR.

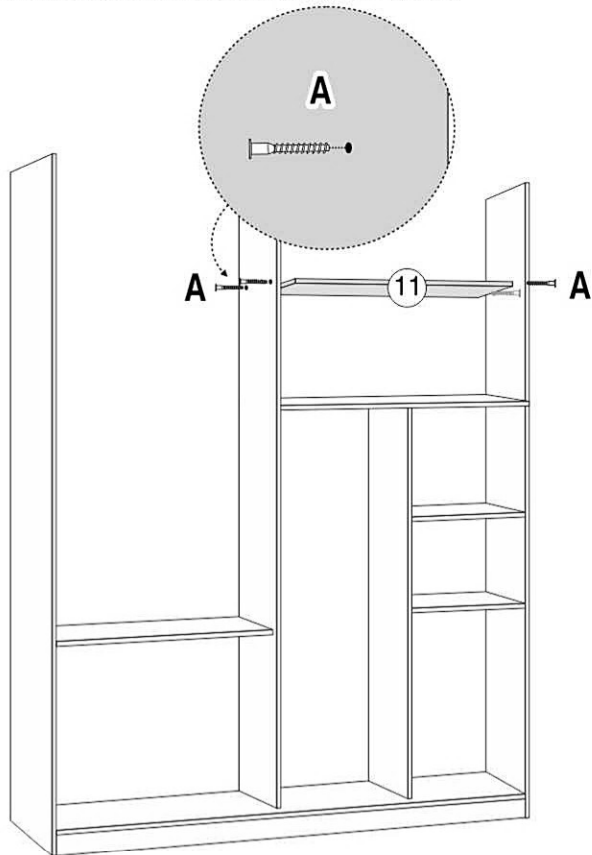

9 PARAFUSAR AS PRATELEIRAS SUPERIORES NAS DIVISÕES E LATERAIS.

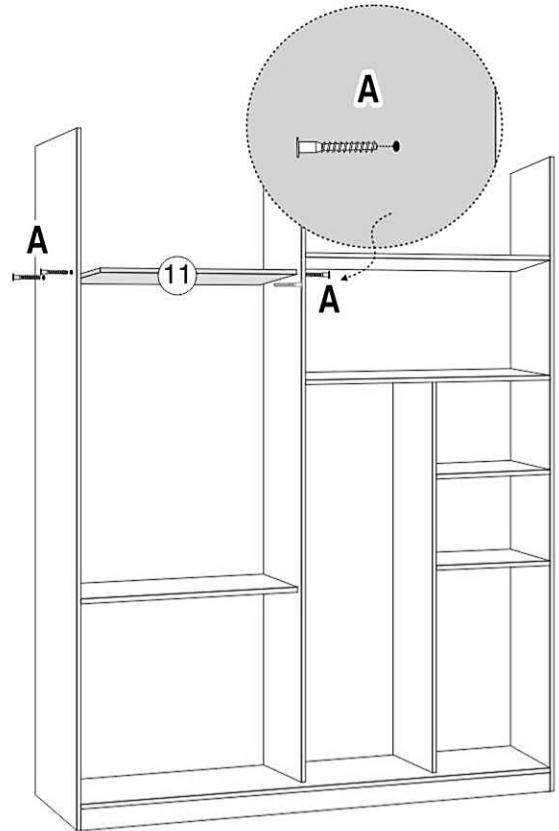

10 PREPARA O TAMPO PARA MONTÁ-LO

**ATENÇÃO:**  
FIXAR O LADO PLANO DO SUPORTE PARALELO  
AO LADO FILETADO DA MOLDURA, LADO ESSE  
DO SUPORTE, QUE FICARÁ EM CONTATO COM  
O TAMPO CONFORME DESENHO ABAIXO.

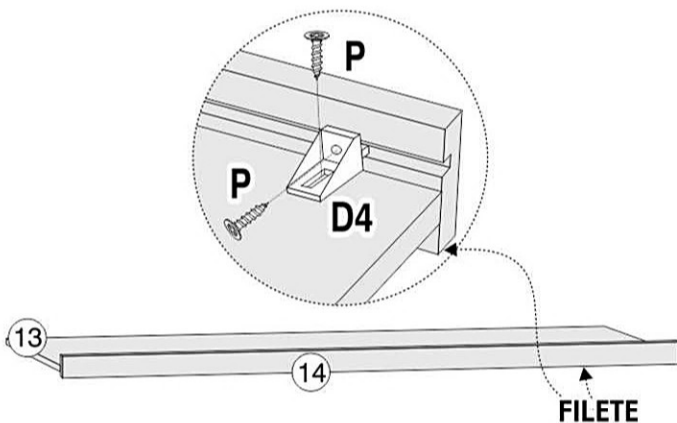

11 ENCAIXAR O TAMPO NAS DIVISÕES E PARAFUSAR O MESMO NAS LATERAIS DIREITA/ESQUERDA.

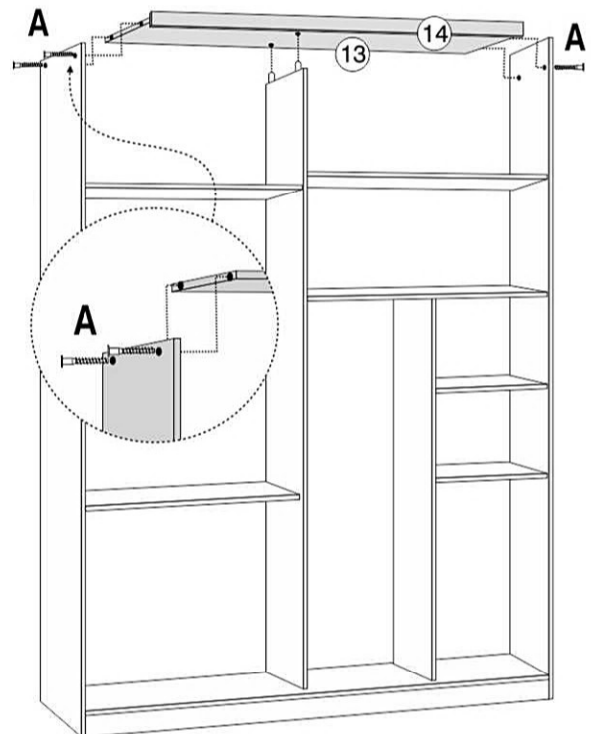

12 PARAFUSAR OS SUPORTES DOS TUBOS OBLONGOS.

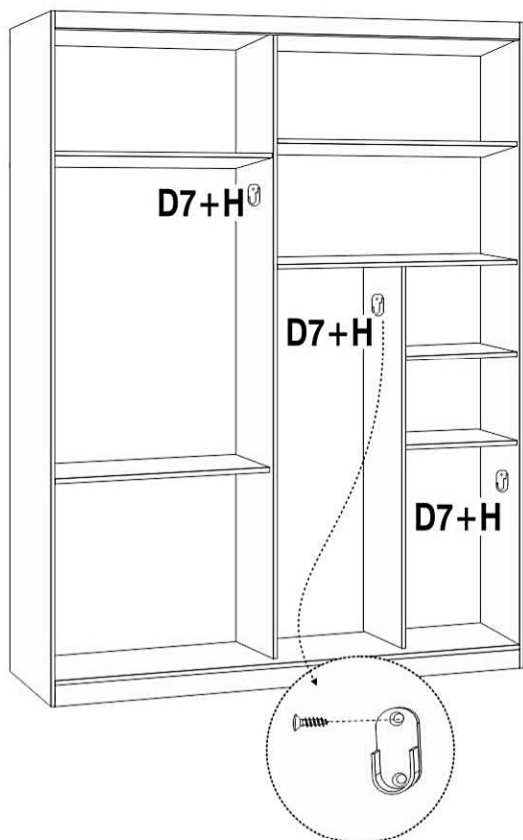

06 - SUPORTE TUBO OBL. **D7**

12 - PARAFUSO 3,5x14 **H**

13 PARAFUSAR AS CORREDIÇAS NOS DISTANCIADORES, CONFORME ORIENTAÇÕES ABAIXO.

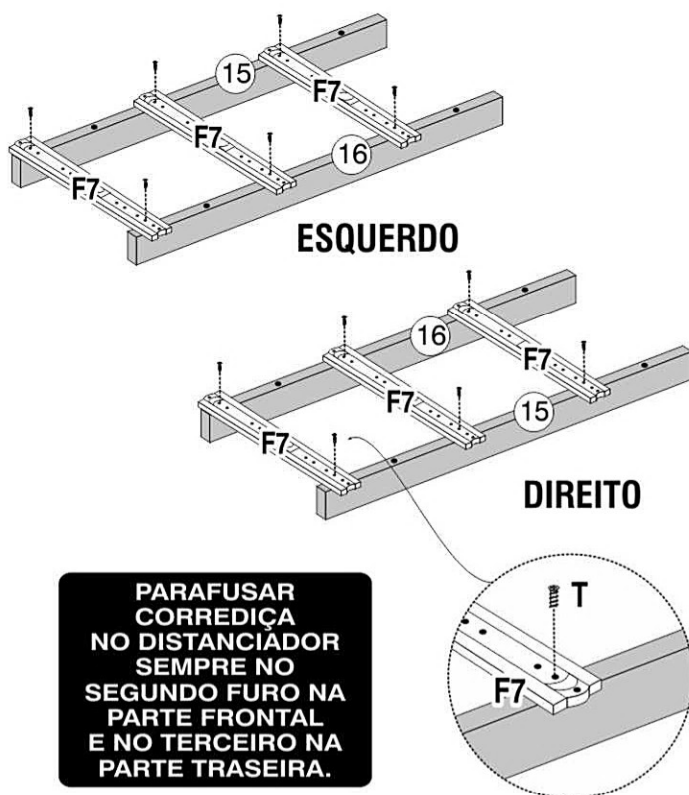

**PARAFUSAR CORREDIÇA NO DISTANCIADOR SEMPRE NO SEGUNDO FURO NA PARTE FRONTAL E NO TERCEIRO NA PARTE TRASEIRA.**

03 PARES - CORREDIÇA **F7**

12 - PARAFUSO 6x12 **T**

14 PARAFUSAR OS DISTANCIADORES, JÁ COM AS CORREDIÇAS CONFORME DESENHO ABAIXO.

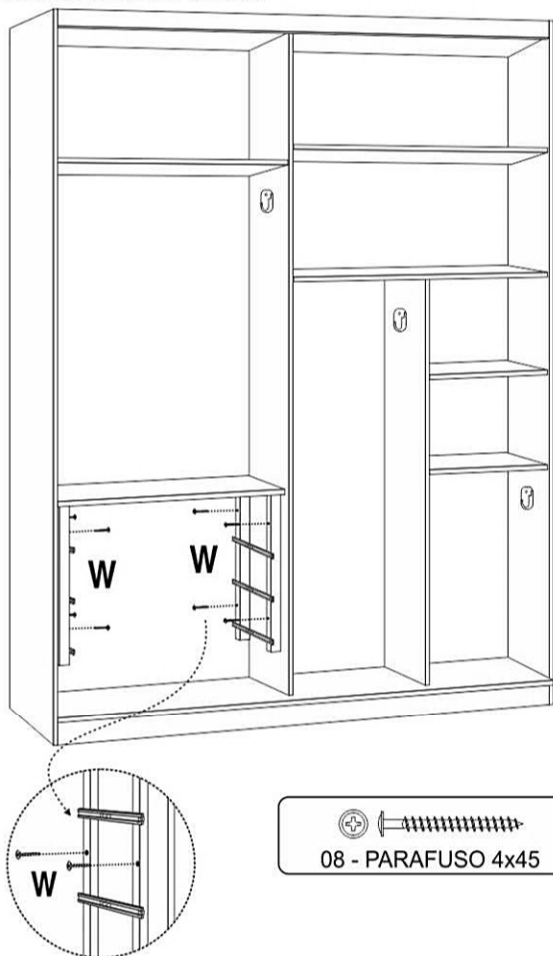

08 - PARAFUSO 4x45 **W**

15 FIXAÇÃO DAS COSTAS, MONTAR DE BAIXO PARA CIMA, VERIFICANDO O NIVELAMENTO DO PISO, PARA QUE AS COSTAS FIQUEM NO ESQUADRO.

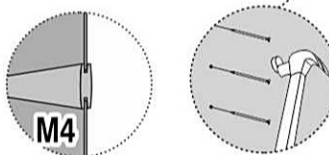
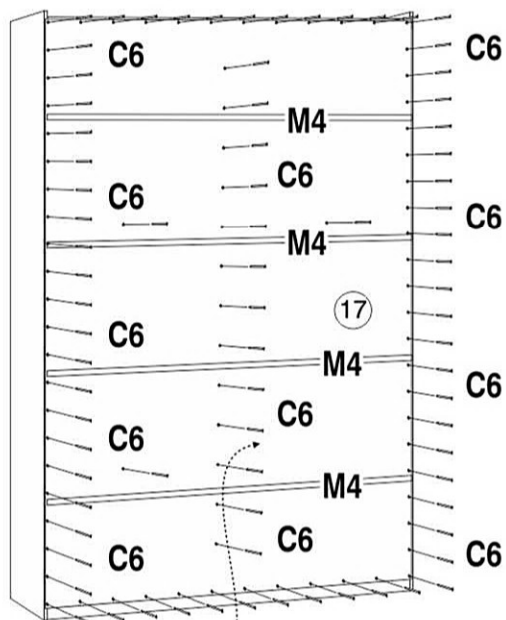

100 - PREGO 10x10 **C6**

**ATENÇÃO: COMECE FAZENDO A COSTA INFERIOR JUNTO A BASE E PREGUE, FAÇA A JUNÇÃO DAS SEGUINTESS COM O PERFIL E PREGUE AS MESMAS CONFORME O DESENHO ACIMA.**

16 EFETUAR A MONTAGEM DAS PORTAS LATERAIS COM/SEM ESPELHO.

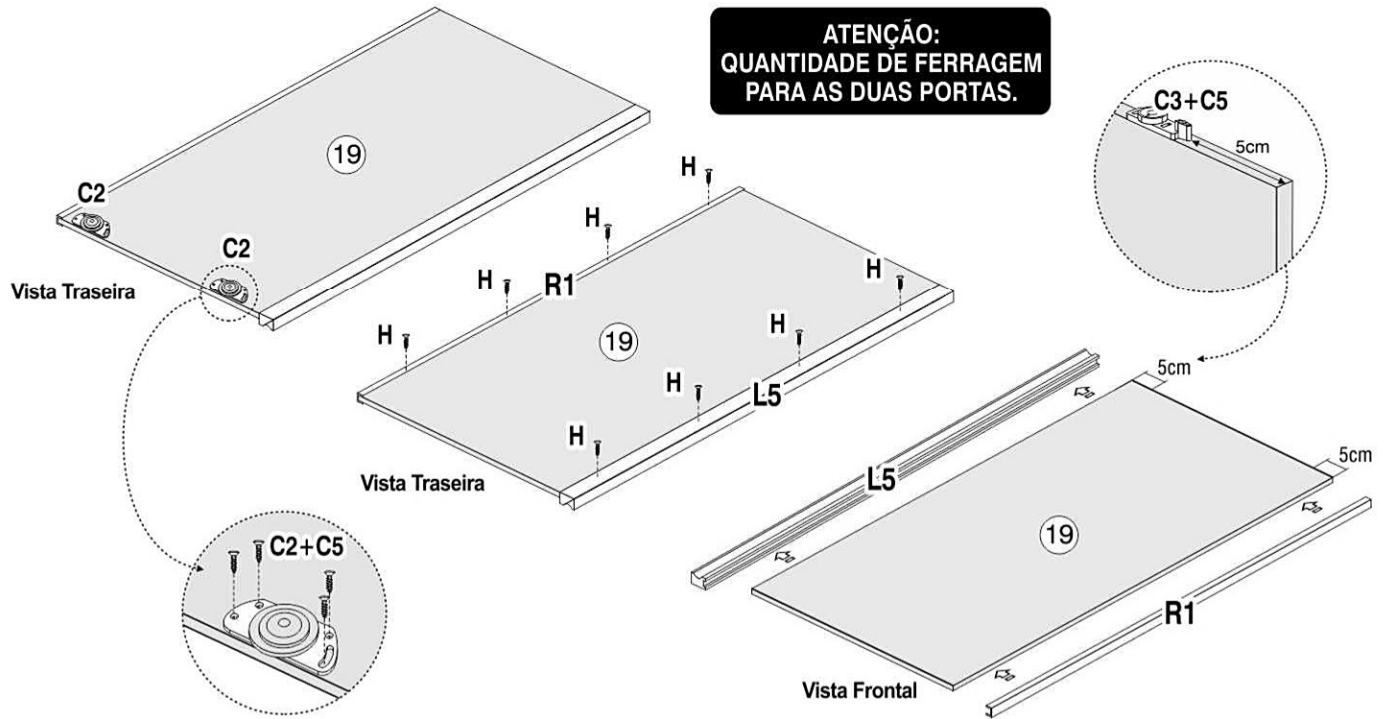

04 - ROLDANA

C2



04 - GUIA SUPERIOR

C3

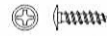

24 - PARAFUSO 3,5x12 FLA.

C5



16 - PARAFUSO 3,5x14

H

17 MONTAR ESPELHO NA PORTA (OPCIONAL).

**O ESPELHO É OPCIONAL**



**NÃO UTILIZAR PARAFUSADEIRA**

**PORTA DIREITA**

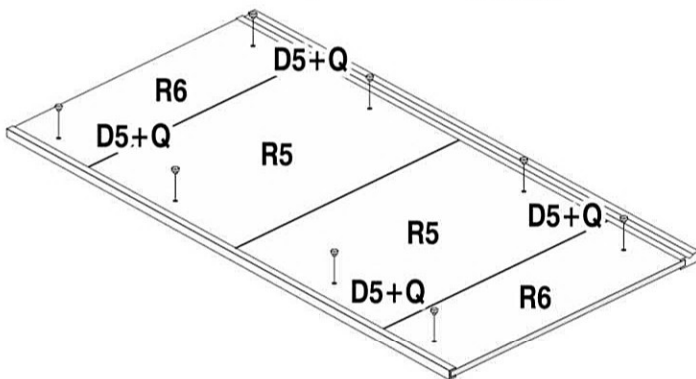
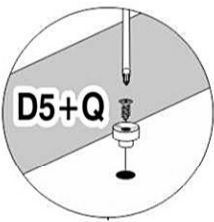

08 - SUP. PINO ESPELHO

D5



08 - PARAFUSO 3,5x16

Q

18 COLOCAÇÃO DO GUIA SUPERIOR E MOLDURA LATERAL..

**ATENÇÃO: ENCOSTAR O GUIA NA MOLDURA E FIXAR O MESMO COM PARAF. 3,5x14.**

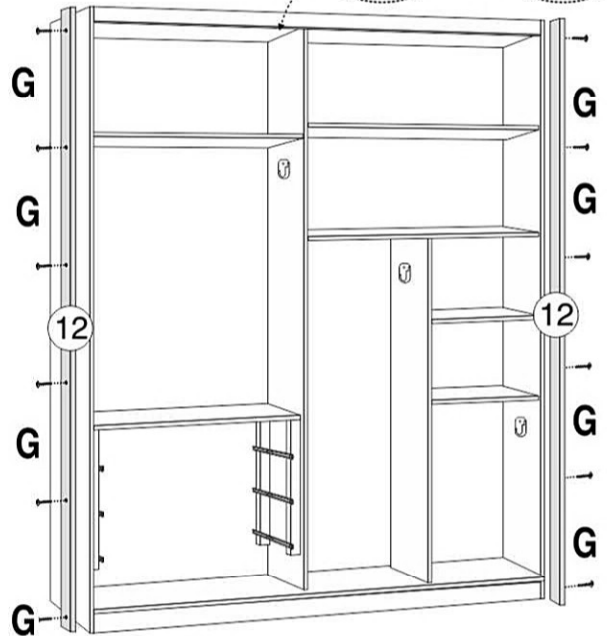
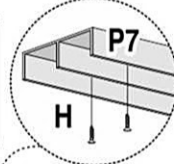

04 - FREIO

C4



16 - PARAF. 3,5x20 Cha Phillips

G



08 - PARAFUSO 3,5x14

H

19 COLOCAÇÃO DAS PORTAS

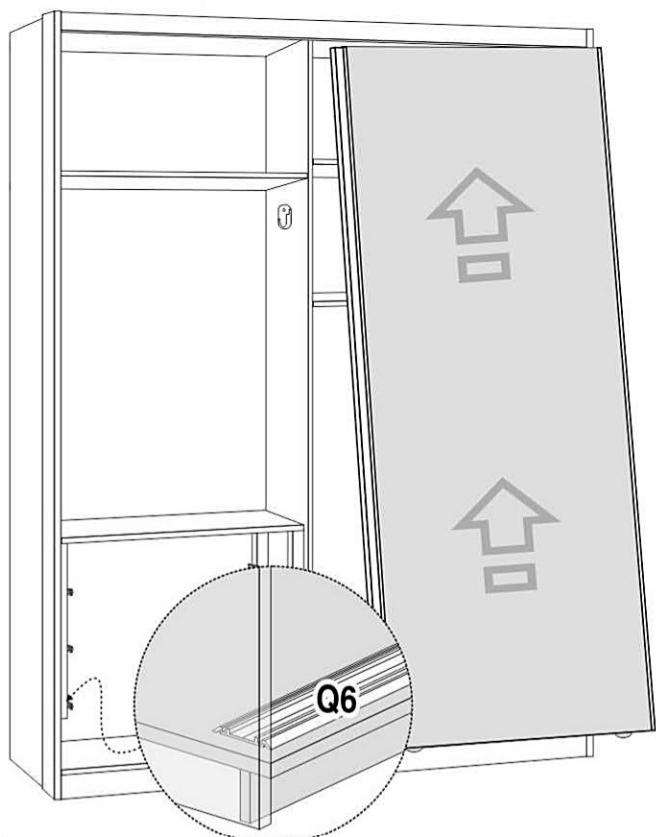

PRIMEIRO ENCAIXE A PORTA NO GUIA SUPERIOR E EM SEGUIDA ENCAIXE NO TRILHO INFERIOR, ALINHE A PORTA E PRAFUSE O TRILHO.

20 MONTAGEM DO TRILHO INFERIOR

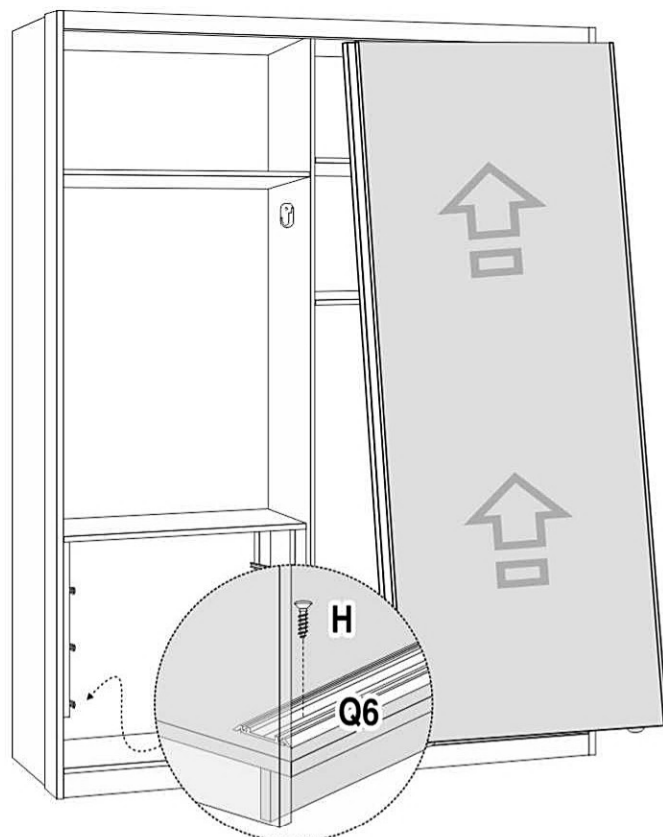

05 - PARAFUSO 3,5x14

21 MONTAGEM DAS 3 GAVETAS.

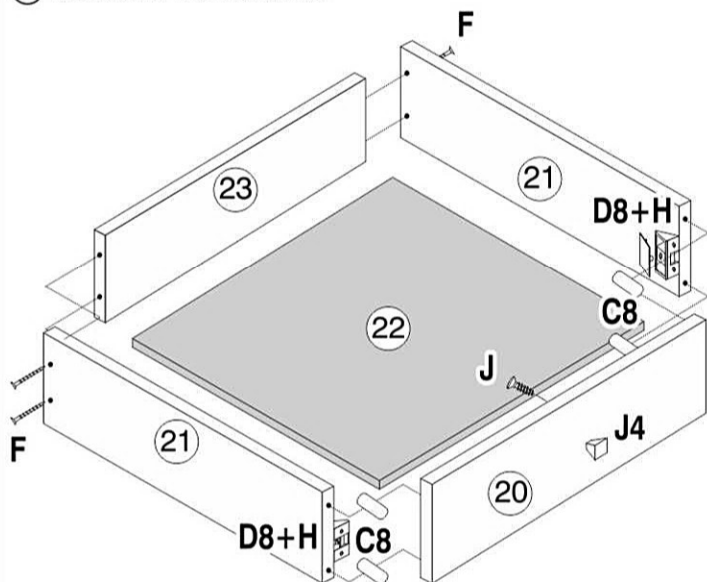

22 PARAFUSAR AS CORREDIÇAS TELESCÓPICAS NAS GAVETAS.

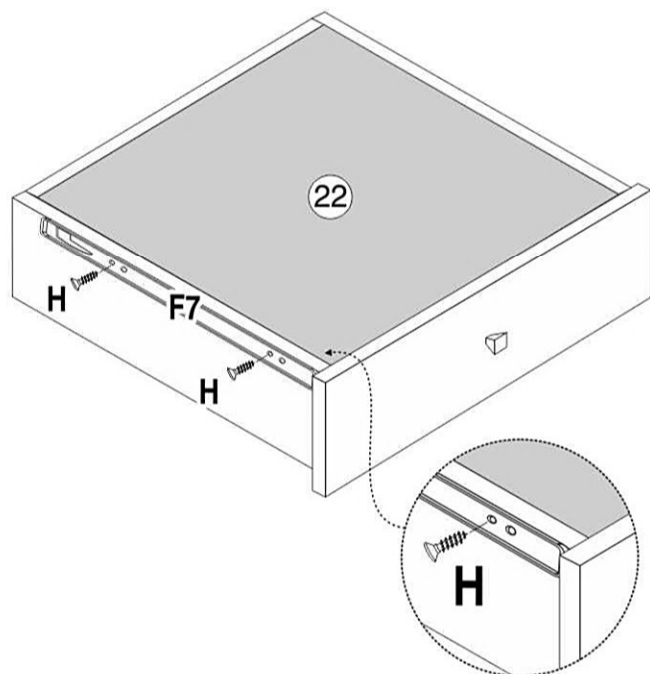

**ATENÇÃO:**  
FAVOR FACEAR A CORREDIÇA NA BASE DA LATERAL, ENCOSTAR A MESMA NA FRENTE DA GAVETA EM SEGUIDA PARAFUSÁ-LA.

03 Pares - CORREDIÇA      12 - PARAFUSO 3,5x14

C8  
12 - CAVILHAS 6x30

D8  
06 - CONECTOR MONT.

F  
12 - PARAFUSO 3,5x35

H  
24 - PARAFUSO 3,5x14

J  
03 - PARAFUSO 3,5x25

J4  
03 - PUXADOR CANAÃ