

MANUAL DE MONTAGEM

ATENÇÃO:

- 1 - Ler atentamente todo o manual antes de iniciar a montagem do móvel.
- 2 - A montagem deve ser feita em uma superfície plana e limpa.
- 3 - Recomenda-se utilizar a embalagem do móvel para forrar e chão e assim não danificá-los

LIMPEZA E CONSERVAÇÃO:

A limpeza do móvel deve ser feita com utilização de pano umedecido com água, podendo conter uma pequena quantidade de álcool. Não utilize produtos abrasivos.

GARANTIA:

90 dias para defeitos de fabricação.

Quantidade de pessoas
necessárias para montar o
móvel

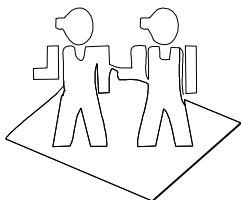

Tempo necessário para a
montagem: 50min





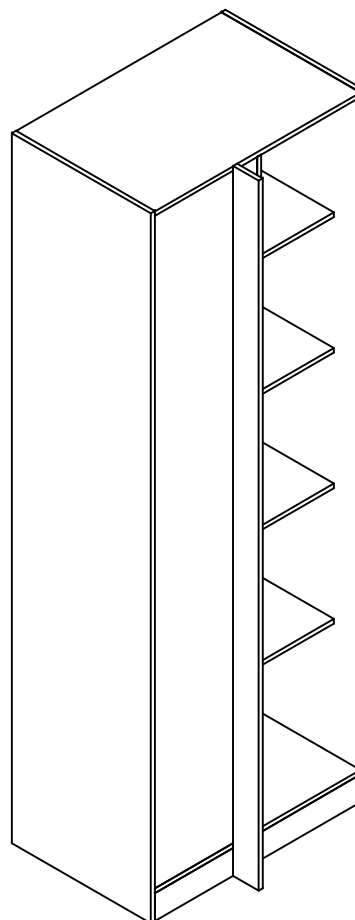
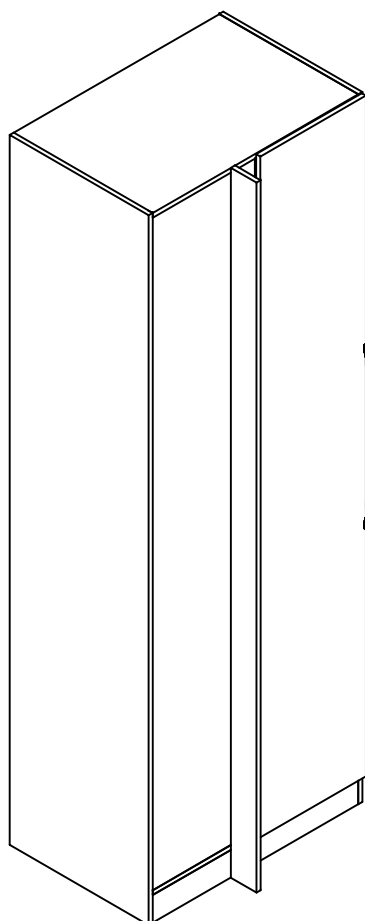
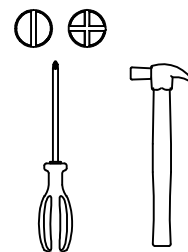







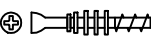

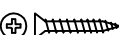
Ferramentas necessárias



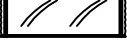









Lista de peças

Código de assistência	Descrição	Quant.	Compr. (mm)	Larg. (mm)	Espes. (mm)	Caixa/ volume
01	Lateral direita	1	2550	520	15	A
02	Lateral esquerda	1	2550	520	15	A
03	Base	1	769	520	15	B
04	Chapéu	1	769	520	15	B
05	Prateleiras	4	769	420	15	B
06	Costa externa	1	2429	383	15	A
07	Pilastra interna	1	2429	96	15	A
08	Pilastra externa	1	2550	96	15	A
09	Rodapés	2	769	90	15	B
10	Porta	1	2455	395	15	A
11	Costas	2	2450	392	3	A

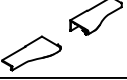
Ferragem

	Código de assistência	Descrição	Quant.
A	30945	 Minifix (parafuso)	8
B	30950	 Minifix (tambor)	8
C	4214	 Parafuso chato 3,5x14 cabeça rebaixada	64
D	491	 Parafuso chato 4,0x25 bicromatizado	4
E	1802	 Cavilha 6x30mm	19
F	107	 Pregos 10 x 10	62
G	149	 Pregos 13 x 15	4
H	899	 Cantoneira de metal	8
I	41	 Cola branca em bisnaga (10g)	1
J	8578	 "L" de Zamaq 13x13	16
K	1901	 Sapata deslizadora preta	4
L	31260	 Tapa furo adesivo 19mm Branco	8
L	40392	 Tapa furo adesivo 19mm Itapua	8
M	21461	 Tapa furo adesivo 13mm Branco	4

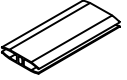
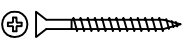
M	40391	 Tapa furo adesivo 13mm Itapua	4
N	40534	 Batente de silicone incolor	2
O	40410	 Etiqueta marca "Kappesberg Premium"	1
P	8229	 Dobradiça reta 35	4
Q	8229	 Calço para dobradiça	4
R	8229	 Parafuso panela 4,0x14 para dobradiça	16
S	25449	 Ponteira para puxador slim cromada	1
S	40401	 Ponteira para puxador slim rose	1
T	25444	 Puxador alumínio slim 455mm	1
U	25827	 Parafuso flange 3,5x14 zincado branco	6
V	40536	 Perfil "H" 2430mm Branco	1
V	40535	 Perfil "H" 2430mm Carvalle	1
W	226	 Parafuso chato 4,0x40 bicromatizado	11



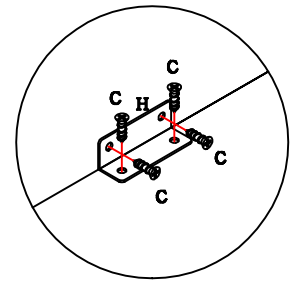
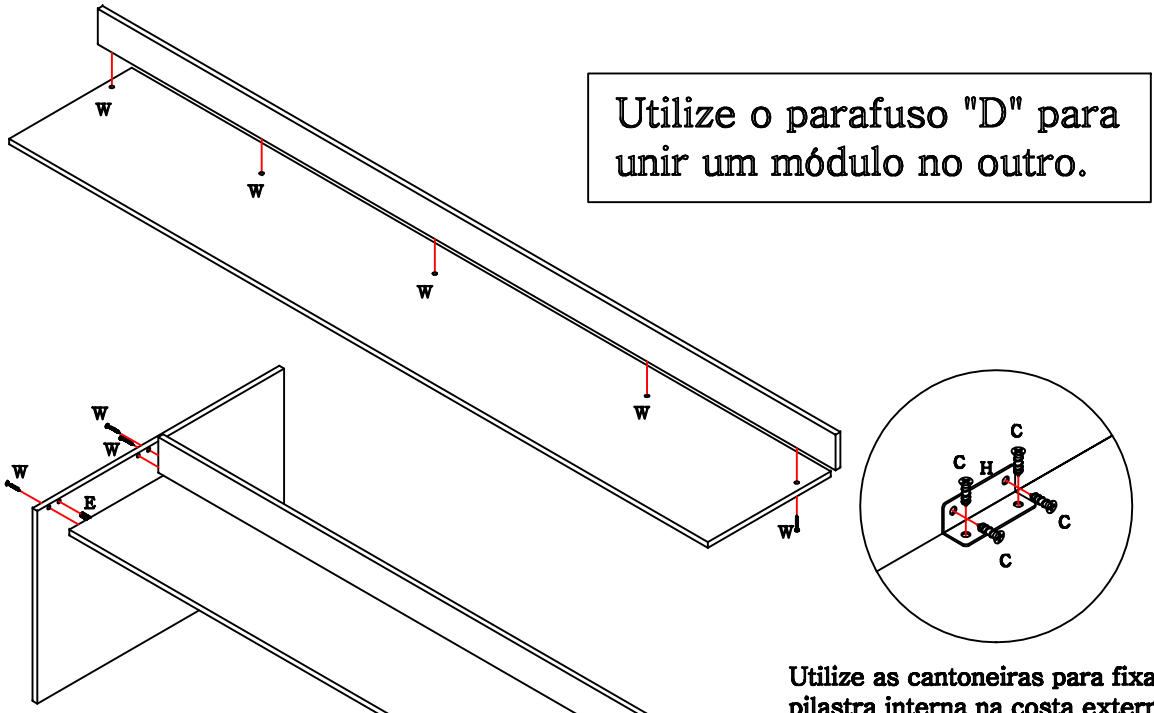

Utilize as cantoneiras para fixar a pilastra interna na costa externa.

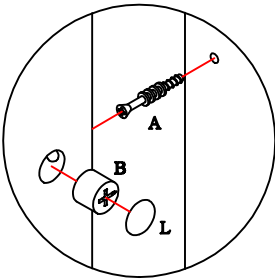

Detalhe da fixação do Minifix.

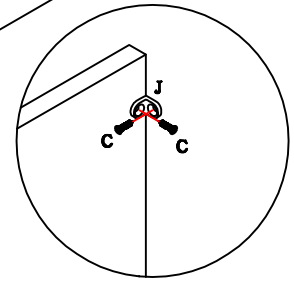
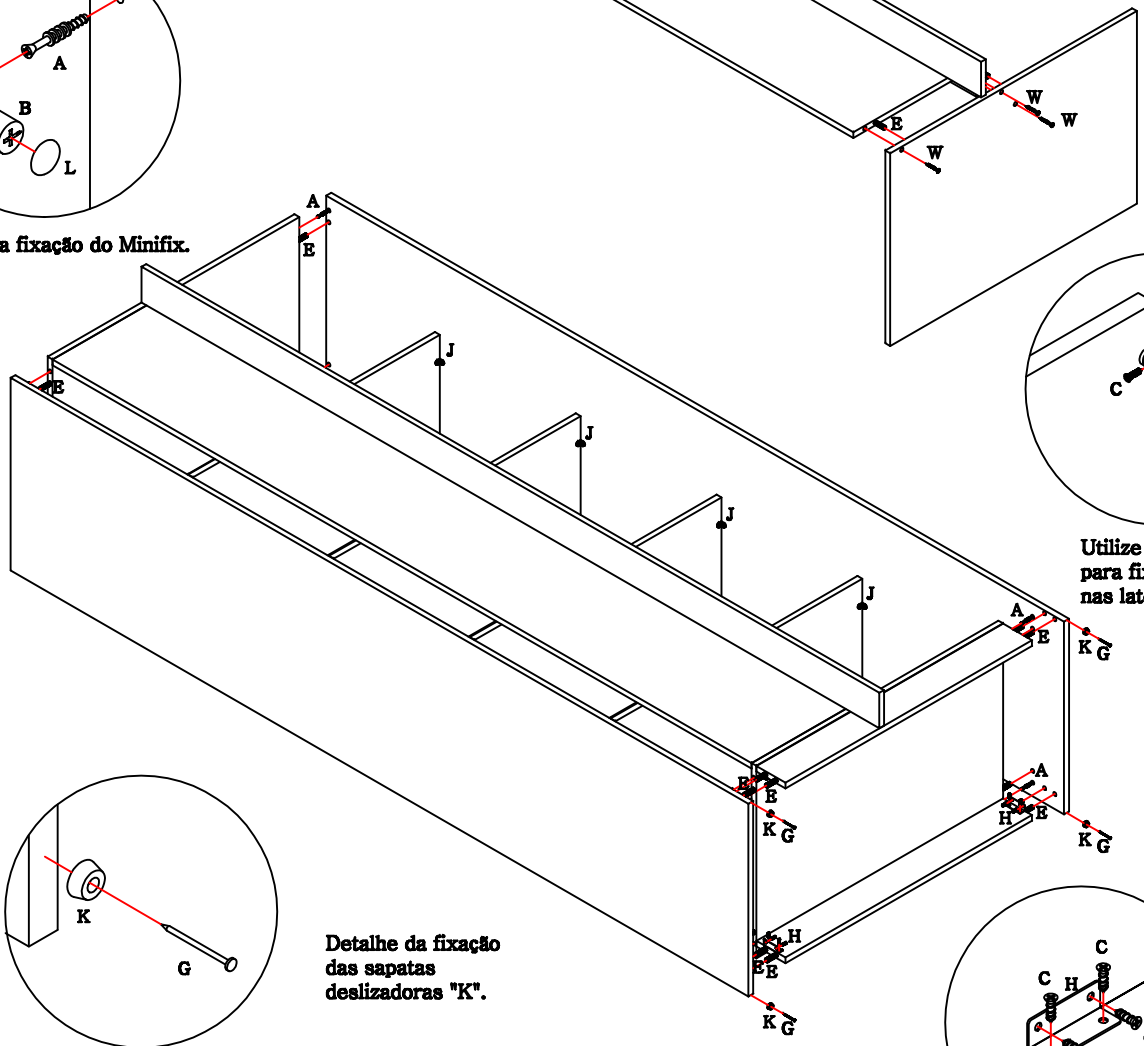

Utilize o L de Zamaq "J" para fixar as prateleiras nas laterais.

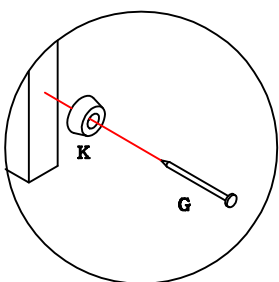

Detalhe da fixação das sapatas deslizadoras "K".

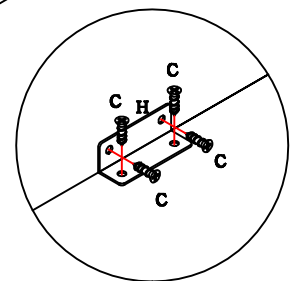

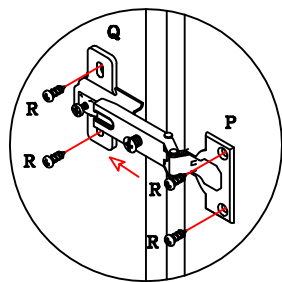

Fixe o puxador com os parafusos "U".

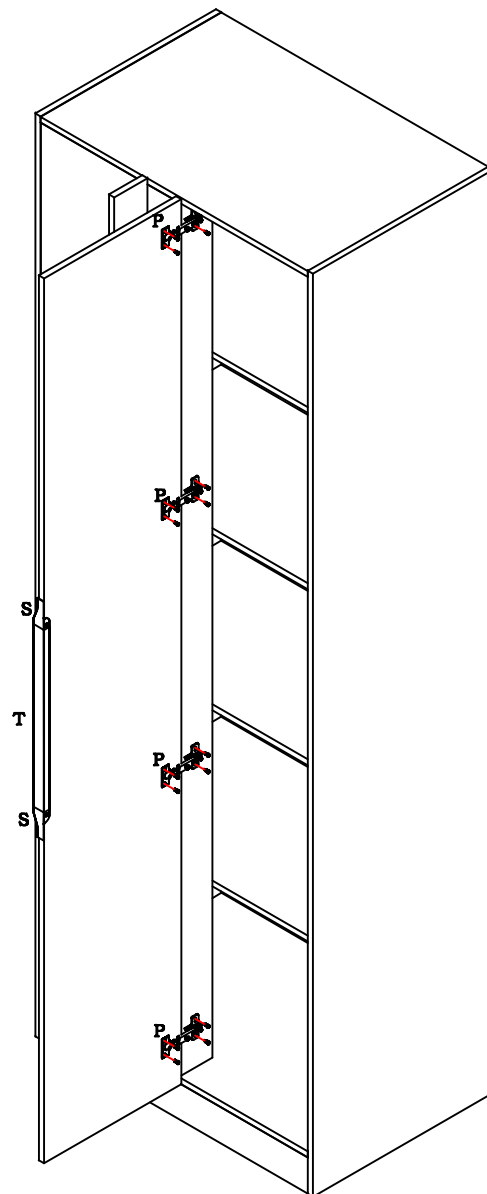
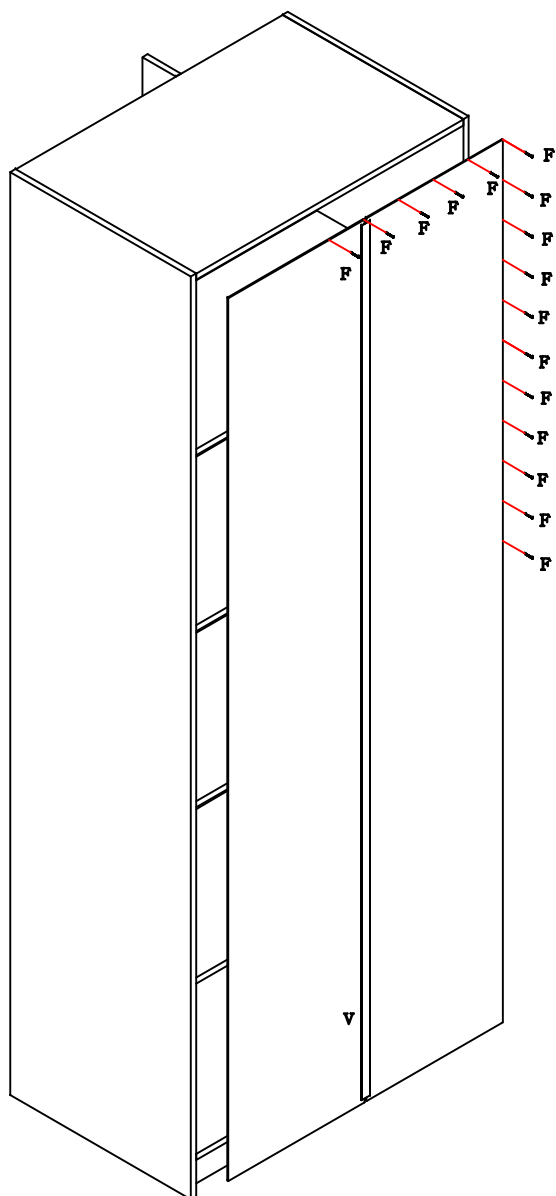

Procedimento de
colocação do perfil H.

