

MANUAL DE MONTAGEM

ATENÇÃO:

- 1 - Ler atentamente todo o manual antes de iniciar a montagem do móvel.
- 2 - A montagem deve ser feita em uma superfície plana e limpa.
- 3 - Recomenda-se utilizar a embalagem do móvel para forrar e chão e assim não danificá-los

LIMPEZA E CONSERVAÇÃO:

A limpeza do móvel deve ser feita com utilização de pano umedecido com água, podendo conter uma pequena quantidade de álcool. Não utilize produtos abrasivos.

GARANTIA:

90 dias para defeitos de fabricação.

Quantidade de pessoas
necessárias para montar o
móvel

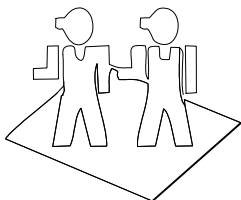







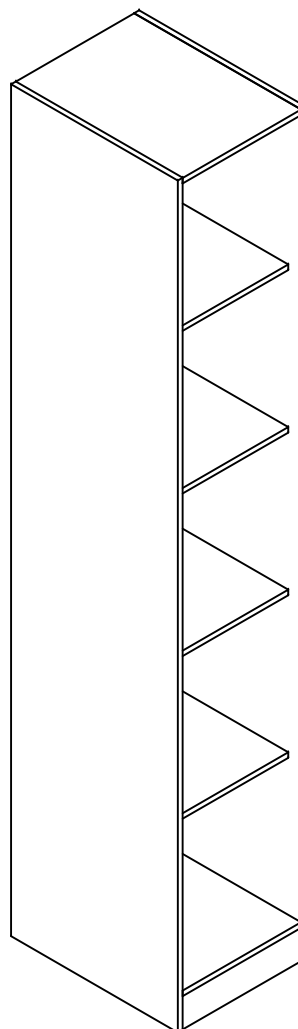
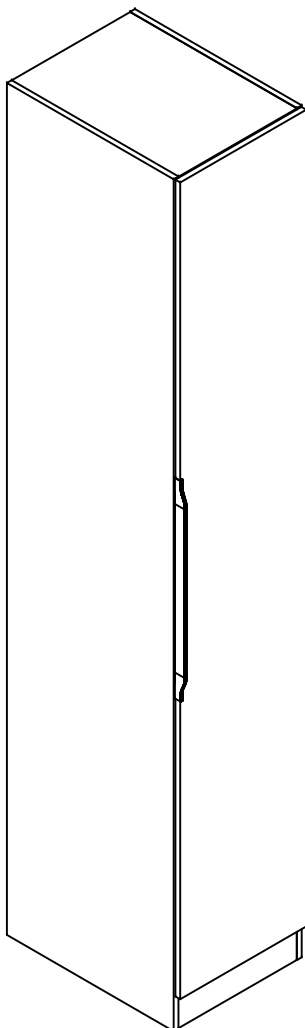
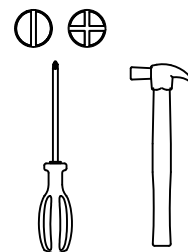



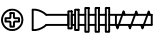
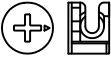

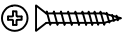
Tempo necessário para a
montagem: 50min

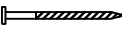

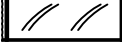





Ferramentas necessárias

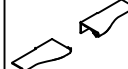
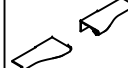

Lista de peças						
Código de assistência	Descrição	Quant.	Compr. (mm)	Larg. (mm)	Espes. (mm)	Caixa/ volume
01	Lateral direita	1	2550	520	15	A
02	Lateral esquerda	1	2550	520	15	A
03	Base	1	569	520	15	A
04	Chapéu	1	569	520	15	A
05	Prateleiras	4	569	450	15	A
06	Rodapés	2	569	90	15	A
07	Porta	1	2455	593	15	A
08	Costa	1	2450	590	3	A

Ferragem			
	Código de assistência	Descrição	Quant.
A	30945	 Minifix (parafuso)	8
B	30950	 Minifix (tambor)	8
C	4214	 Parafuso chato 3,5x14 cabeça rebaixada	48
D	491	 Parafuso chato 4,0x25 bicromatizado	4
E	1802	 Cavilha 6x30mm	16
F	107	 Prego 10 x 10	58
G	149	 Prego 13 x 15	4
H	899	 Cantoneira de metal	4
I	41	 Cola branca em bisnaga (10g)	1
J	8578	 "L" de Zamaq 13x13	16
K	1901	 Sapata deslizadora preta	4
L	45014	 Tapa furo adesivo 19mm Branco	8
L	40392	 Tapa furo adesivo 19mm Itapua	8
M	21461	 Tapa furo adesivo 13mm Branco	4
M	40391	 Tapa furo adesivo 13mm Itapua	4

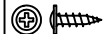
N	40534	 Batente de silicone incolor	2
O	40410	 Etiqueta marca "Kappesberg Premium"	1
P	7787	 Dobradiça reta 35	4
Q	7787	 Calço para dobradiça	4
R	7787	 Parafuso panela 4,0x14 para dobradiça	16
S	25449	 Ponteira para puxador slim cromada	1
S	40401	 Ponteira para puxador slim rose	1
T	25444	 Puxador alumínio slim 455mm	1
U	25827	 Parafuso flange 3,5x14 zincado branco	6



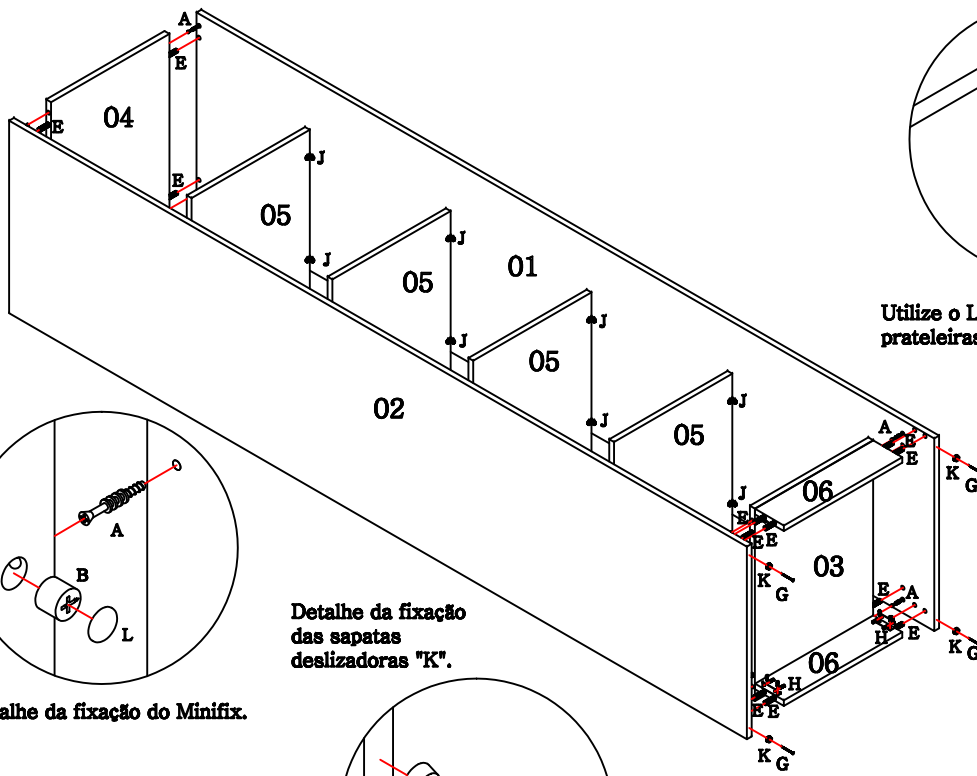

Utilize o L de Zamaq "J" para fixar as prateleiras nas laterais.

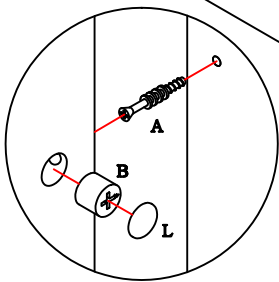

Detalhe da fixação do Minifix.

Detalhe da fixação das sapatas deslizadoras "K".

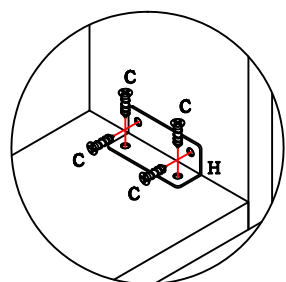
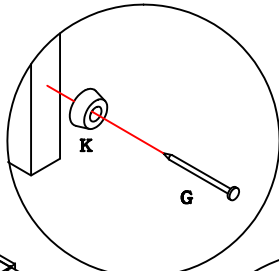

Fixe os rodapés com as cantoneiras "H" pelo lado interno.

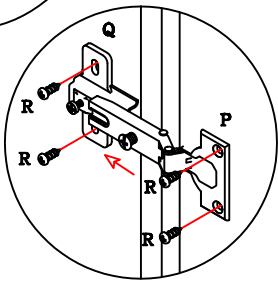
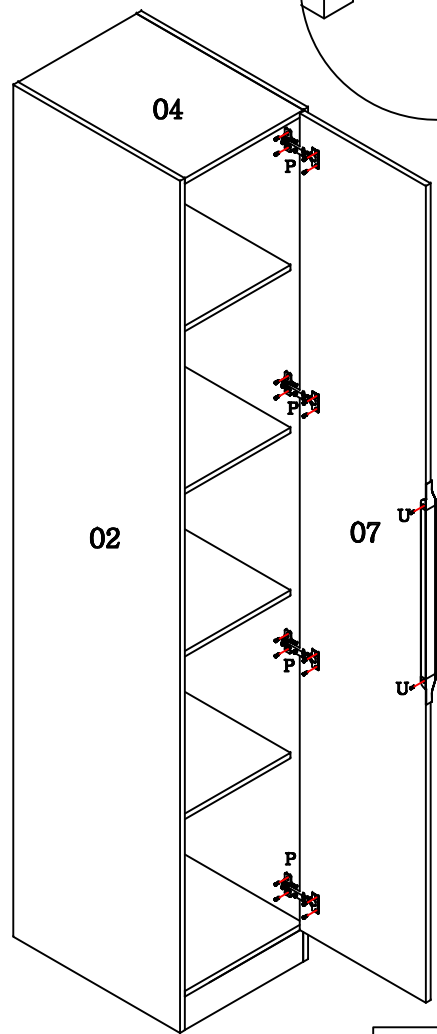

Utilize os parafusos "U" para fixar o puxador.

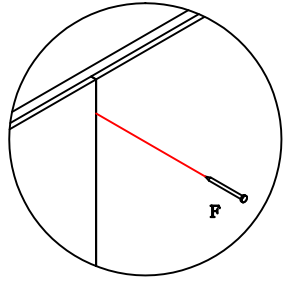

Detalhe da fixação dos pregos nas costas do móvel.

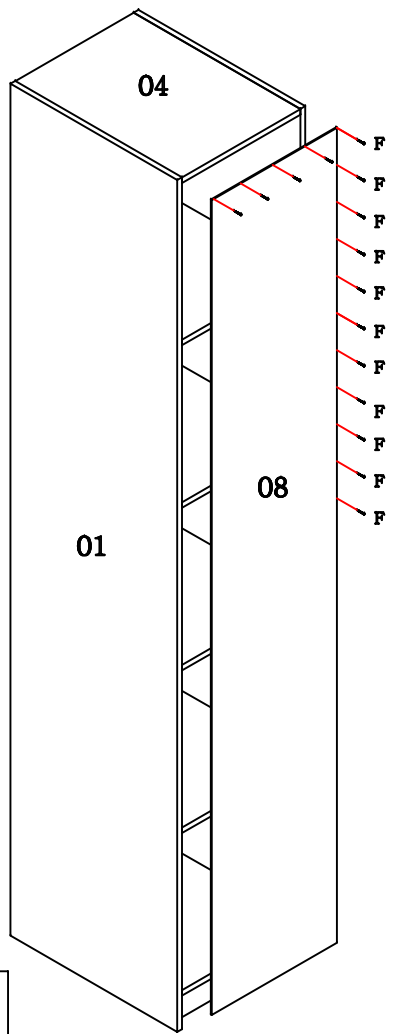

Utilize o parafuso "D" para unir um módulo no outro.