

# MANUAL DE MONTAGEM

## ATENÇÃO:

- 1 - Ler atentamente todo o manual antes de iniciar a montagem do móvel.
- 2 - A montagem deve ser feita em uma superfície plana e limpa.
- 3 - Recomenda-se utilizar a embalagem do móvel para forrar o chão e assim não danificá-los

## LIMPEZA E CONSERVAÇÃO:

A limpeza do móvel deve ser feita com utilização de pano umedecido com água, podendo conter uma pequena quantidade de álcool. Não utilize produtos abrasivos.

## GARANTIA:

90 dias para defeitos de fabricação.

Quantidade de pessoas  
necessárias para montar o  
móvel

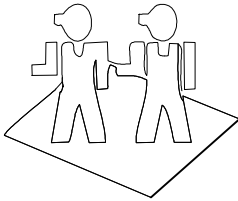

Tempo necessário para a  
montagem: 35min





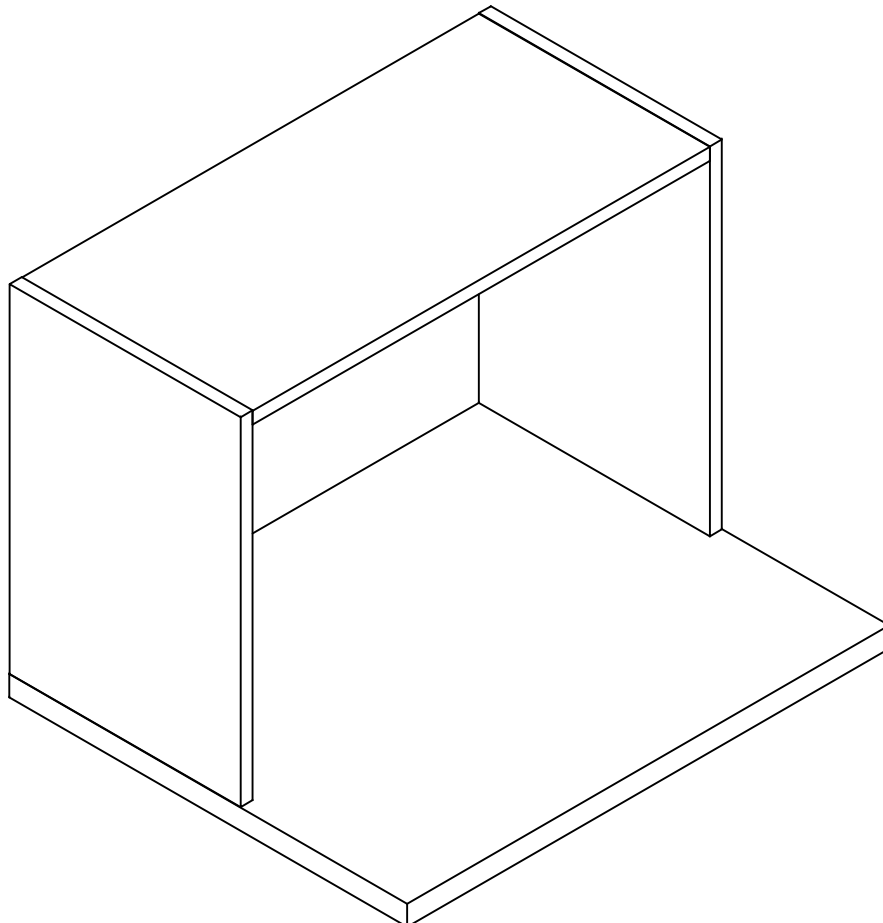
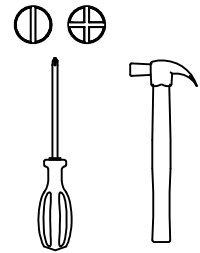







Ferramentas necessárias

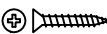







Lista de peças

Código de assistência	Descrição	Quant.	Compr. (mm)	Larg. (mm)	Espes. (mm)	Caixa/ volume
01	Lateral direita	1	380	320	15	A
02	Lateral esquerda	1	380	320	15	A
03	Chapéu	1	569	320	15	A
04	Base	1	600	416	25	A
05	Costa	1	385	590	3	A

Ferragem

	Código de assistência	Descrição	Quant.
A	1260	 Parafuso estrutural 7 x 70	4
B	95	 Parafuso flange 5,0x50 zincado branco	2
D	491	 Parafuso chato 4,0x25 bicromatizado	4
E	4214	 Parafuso chato 3,5x14 cabeça rebaixada	4
F	107	 Prego 10 x 10	25
G	1802	 Cavilha 6x30mm	4
H	248	 Chave allen Z	1
I	10745	 Buchta nylon 8x50	2
J	17024	 Suporte aéreo metalizado zincado branco	2
K	6959	 Capa para suporte aéreo metal branca	2

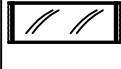
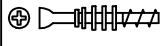
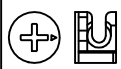
L	21461	 Tapa furo adesivo Branco	4
L	40391	 Tapa furo adesivo Itapua	4
M	31260	 Tapa furo adesivo 19mm Branco	4
M	40392	 Tapa furo adesivo 19mm Itapua	4
N	1493	 Tampa CPL BR 13 mm	4
N	53	 Tampa CPL Teca 13 mm	4
O	40410	 Etiqueta marca "Kappesberg Premium"	1
P	41	 Cola branca em bisnaga (10g)	1
Q	30945	 Minifix (parafuso)	4
R	30950	 Minifix (tambor)	4



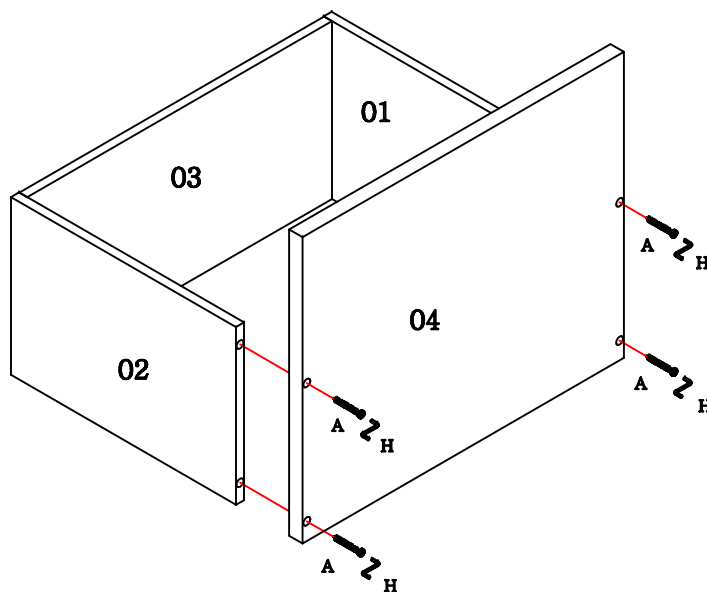
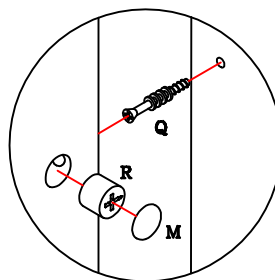
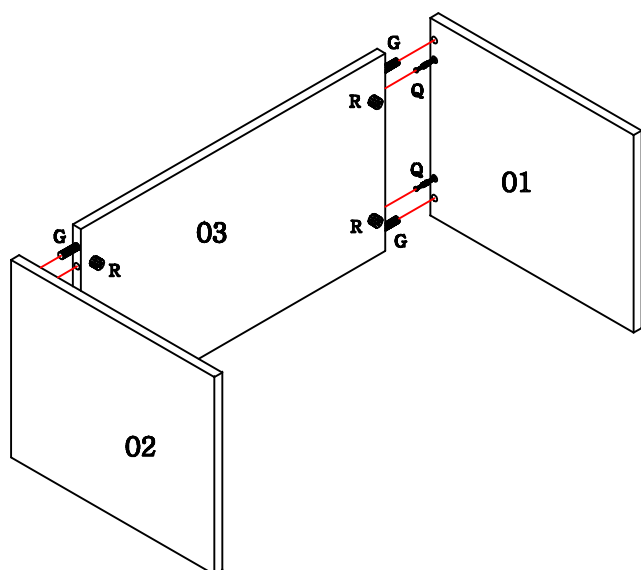

Utilize o parafuso "D" para fixar um módulo em outro.

Ao fixar a costa, recomenda-se um espaçamento de aproximadamente 10 cm entre os pregos.

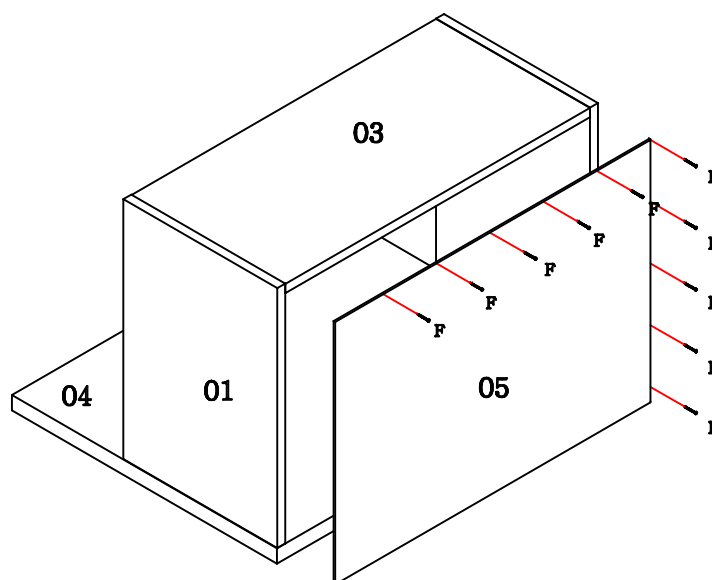

Para fixar o nicho microondas na parede:

- Em cada lateral fixe um suporte aéreo metalizado "J" com o parafuso "E" e na parede com o parafuso "A" e com a bucha "I".
- Coloque uma capa "K" em cada suporte "J".