

MANUAL DE MONTAGEM

ATENÇÃO:

- 1 - Ler atentamente todo o manual antes de iniciar a montagem do móvel.
- 2 - A montagem deve ser feita em uma superfície plana e limpa.
- 3 - Recomenda-se utilizar a embalagem do móvel para forrar e chão e assim não danificá-los

LIMPEZA E CONSERVAÇÃO:

A limpeza do móvel deve ser feita com utilização de pano umedecido com água, podendo conter uma pequena quantidade de álcool. Não utilize produtos abrasivos.

GARANTIA:

90 dias para defeitos de fabricação.

Quantidade de pessoas
necessárias para montar o
móvel

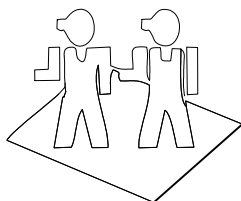



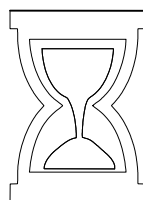



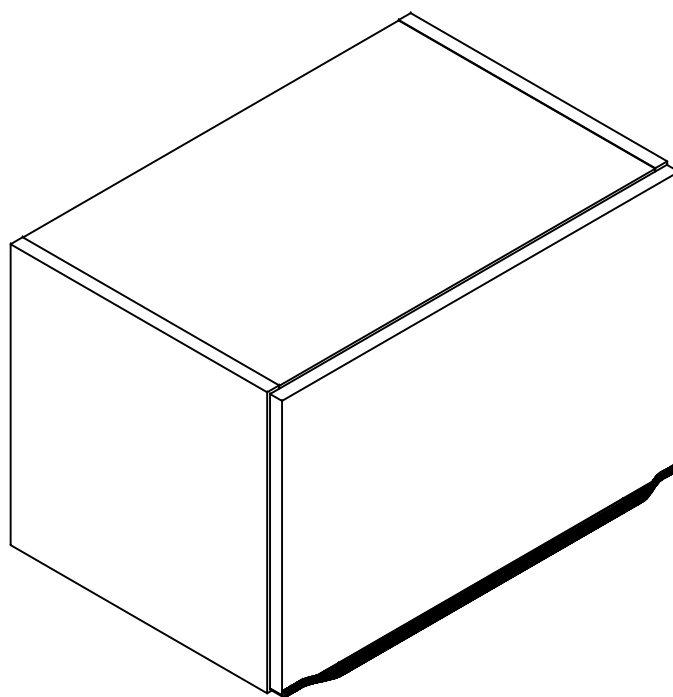
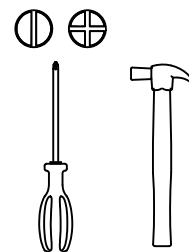



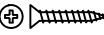

Tempo necessário para a
montagem: 35min









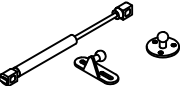

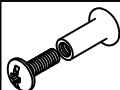
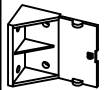
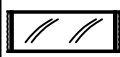
Ferramentas necessárias

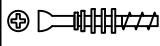
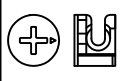

Lista de peças						
Código de assistência	Descrição	Quant.	Compr. (mm)	Larg. (mm)	Espes. (mm)	Caixa/ volume
01	Latera direita	1	325	420	15	A
02	Lateral esquerda	1	325	420	15	A
03	Base	1	569	420	15	A
04	Chapéu	1	569	420	15	A
05	Porta	1	595	318	15	A
06	Costa	1	590	315	3	A

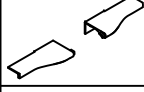
Ferragem			
	Código de assistência	Descrição	Quant.
A	95	 Parafuso flange 5,0x50 zincado branco	2
B	491	 Parafuso chato 4,0x25 bicromatizado	4
C	4214	 Parafuso chato 3,5x14 cabeça rebaixada	12
D	107	 Prego 10 x 10	27
E	1802	 Cavilha 6x30mm	8
F	40534	 Batente de silicone	2
G	529	 Buchta nylon 8x50	2
H	17024	 Suporte aéreo metalizado zincado branco	2
I	6959	 Capa para suporte aéreo metal branca	2
I	28549	 Capa para suporte aéreo metal Pisano	2
J	7787	 Dobradiça reta 35	2
K	7787	 Calço para dobradiça	2
L	7787	 Parafuso panela 4,0x14 para dobradiça	4
M	6955	 Pistão a gás de 80N	1

N	8688		Parafuso união metálico	4
O	7373		Cantoneira plástica branca com capa	2
Q	41		Cola branca em bisnaga (10g)	1
R	21461		Tapa furo adesivo 13mm Branco	4
R	40391		Tapa furo adesivo 13mm Itapua	4
S	30945		Minifix (parafuso)	8
T	30950		Minifix (tambor)	8
U	45014		Tapa furo adesivo 19mm Branco	8
U	40392		Tapa furo adesivo 19mm Itapua	8
V	25444		Puxador alumínio slim 455mm	1
W	25449		Ponteira Cromada para puxador slim	1
W	40401		Ponteira Rose para puxador slim	1
Z	25827		Parafuso flange 3,5x14 zincado branco	6



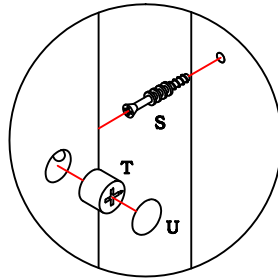
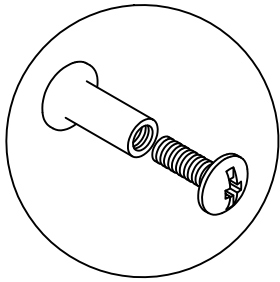

Detalhe da fixação do Minifix.

As batentes de silicone "G" são colocadas duas em cada porta, para suavizar eventuais impactos.

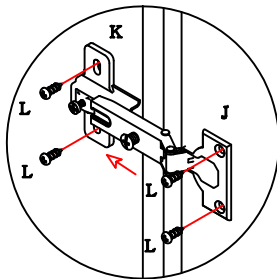
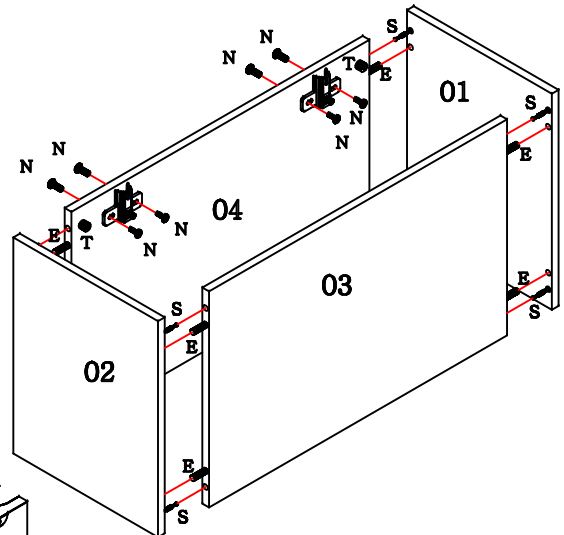

A dobradiça "J" deve ser encaixada no calço "K" e estes colocados com os parafusos "L" na porta e "N" no chapéu, observando o procedimento a cima.

Utilize os parafusos "Z" para fixar o puxador.

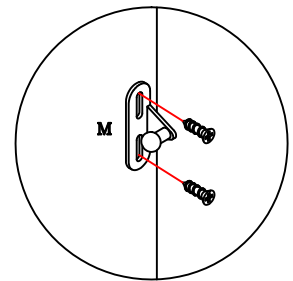
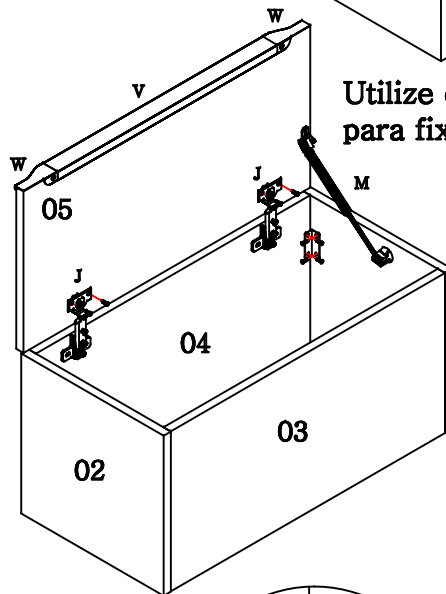

Utilize o parafuso "B" para fixar um módulo em outro.

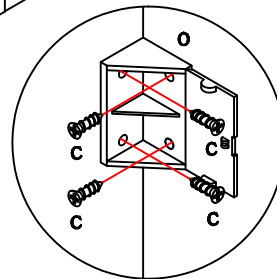

Utilize uma cantoneira plástica "O" em cada lateral para melhor fixação do chapéu.

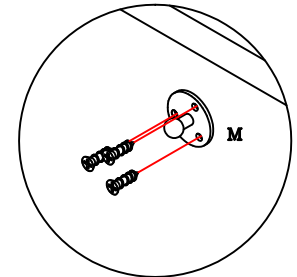

Ao fixar a costa, recomenda-se um espaçamento de aproximadamente 10 cm entre os pregos.

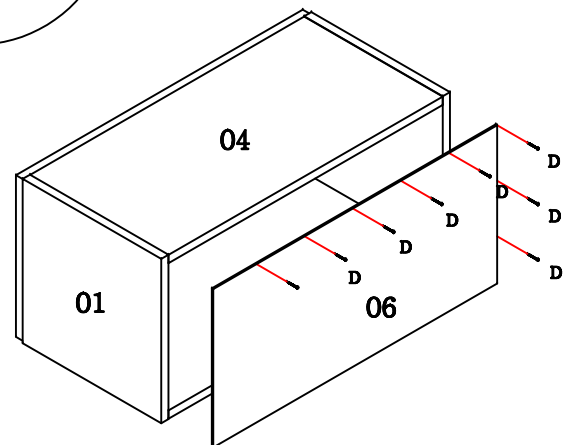

Para fixar o aéreo na parede:

- Em cada lateral fixe um suporte aéreo metalizado "H" com o parafuso "C" e na parede com o parafuso "A" e com a bucha "G".
- Coloque uma capa "I" em cada suporte "H".