

MANUAL DE MONTAGEM

ATENÇÃO:

- 1 - Ler atentamente todo o manual antes de iniciar a montagem do móvel.
- 2 - A montagem deve ser feita em uma superfície plana e limpa.
- 3 - Recomenda-se utilizar a embalagem do móvel para forrar e chão e assim não danificá-los

LIMPEZA E CONSERVAÇÃO:

A limpeza do móvel deve ser feita com utilização de pano umedecido com água, podendo conter uma pequena quantidade de álcool. Não utilize produtos abrasivos.

GARANTIA:

90 dias para defeitos de fabricação.

Quantidade de pessoas
necessárias para montar o
móvel

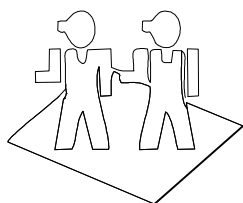

Tempo necessário para a
montagem: 35min





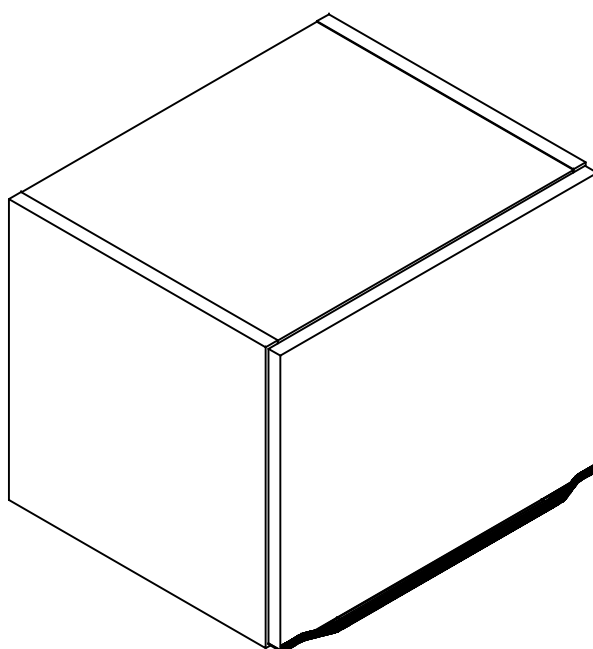
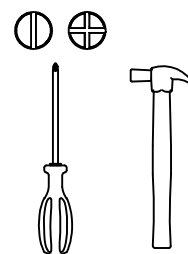





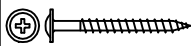
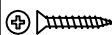

Ferramentas necessárias









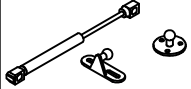

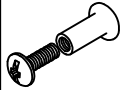
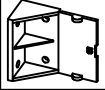

Lista de peças

Código de assistência	Descrição	Quant.	Compr. (mm)	Larg. (mm)	Espes. (mm)	Caixa/ volume
01	Latera direita	1	325	420	15	A
02	Lateral esquerda	1	325	420	15	A
03	Base	1	369	420	15	A
04	Chapéu	1	369	420	15	A
05	Porta	1	395	318	15	A
06	Costa	1	390	315	3	A

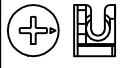
Ferragem

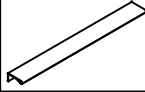
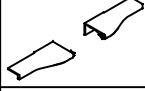
Código de assistência	Descrição	Quant.
A 95	 Parafuso flange 5,0x50 zincado branco	2
B 491	 Parafuso chato 4,0x25 bicromatizado	4
C 4214	 Parafuso chato 3,5x14 cabeça rebaixada	12
D 107	 Prego 10 x 10	27
E 1802	 Cavilha 6x30mm	8
F 40534	 Batente de silicone	2
G 529	 Bucha nylon 8x50	2
H 17024	 Suporte aéreo metalizado zincado branco	2
I 6959	 Capa para suporte aéreo metal branca	2
J 7787	 Dobradiça reta 35	2
K 7787	 Calço para dobradiça	2
L 7787	 Parafuso panela 4,0x14 para dobradiça	4
M 6955	 Pistão a gás de 80N	1

N 8688	 Parafuso união metálico	4
O 7373	 Cantoneira plástica branca com capa	2
P 40410	 Etiqueta marca "Kappesberg Premium"	1
Q 41	 Cola branca em bianaça (10g)	1
R 21461	 Tapa furo adesivo Branco	4
R 40391	 Tapa furo adesivo Itapua	4
S 30945	 Minifix (parafuso)	8
T 30950	 Minifix (tambor)	8
U 31260	 Tapa furo adesivo 19mm Branco	8
U 40392	 Tapa furo adesivo 19mm Itapua	8
V 25447	 Puxador alumínio slim 255mm	1
W 25449	 Ponteira Cromada para puxador slim	1
W 40401	 Ponteira Rose para puxador slim	1
Z 25827	 Parafuso flange 3,5x14 zincado branco	6



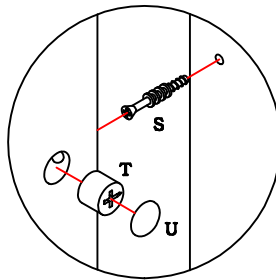
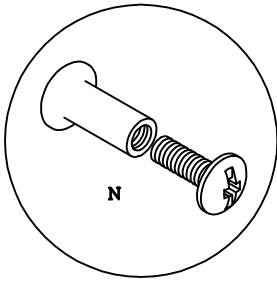

Detalhe da fixação do Minifix.

As batentes de silicone "G" são colocadas duas em cada porta, para suavizar eventuais impactos.

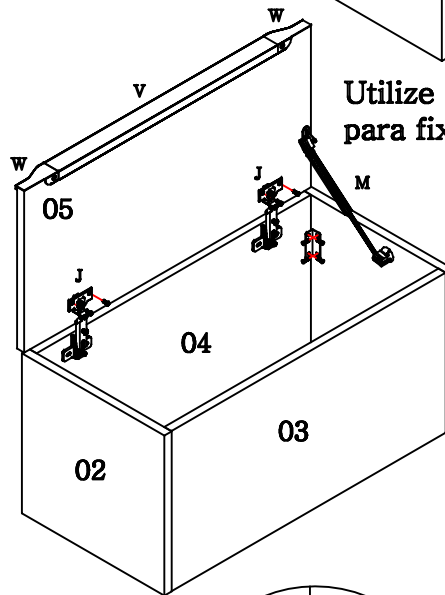
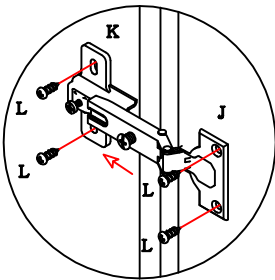
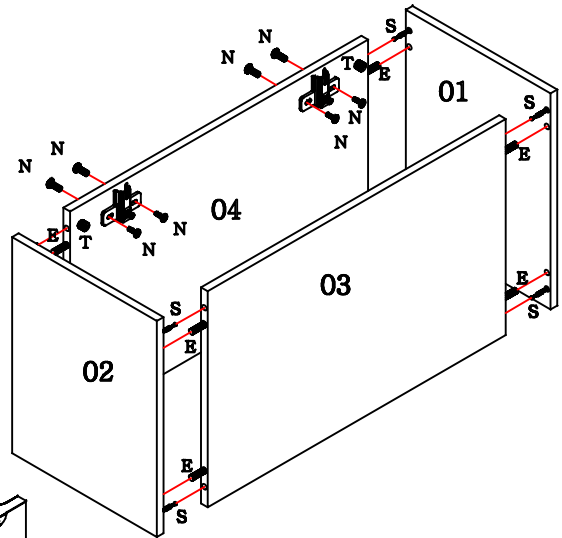

Utilize os parafusos "Z" para fixar o puxador.

A dobradiça "J" deve ser encaixada no calço "K" e estes colocados com os parafusos "L" na porta e "N" no chapéu, observando o procedimento a cima.

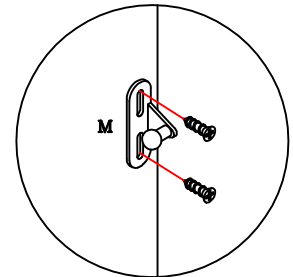

Utilize o parafuso "B" para fixar um módulo em outro.

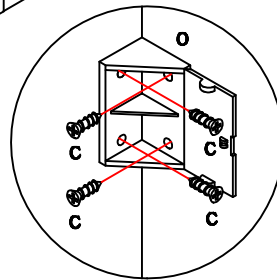
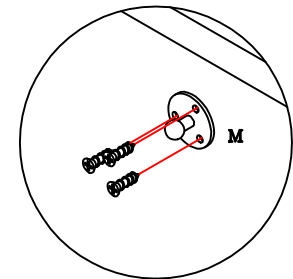

Utilize uma cantoneira plástica "O" em cada lateral para melhor fixação do chapéu.

Ao fixar a costa, recomenda-se um espaçamento de aproximadamente 10 cm entre os pregos.

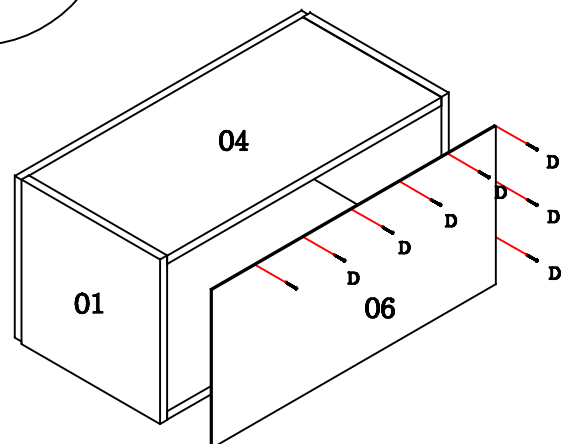

Para fixar o aéreo na parede:

- Em cada lateral fixe um suporte aéreo metalizado "H" com o parafuso "C" e na parede com o parafuso "A" e com a bucha "G".
- Coloque uma capa "I" em cada suporte "H".