



JCM
movelaria

CABECEIRA SONHAR QUEEN/KING
SONHAR HEADBOARD QUEEN/KING
CABECERA SONHAR QUEEN/KING

xmount

ENCONTRE UM MONTADOR
FAÇA SEU ORÇAMENTO

▶ BAIXE O APP

Cupom: JCM30



Indicamos que a montagem dos produtos seja realizada com parafusadeira eléctrica e por um montador profissional.
We recommend that a professional furniture assembler assemble the product by using a cordless screwdriver.
Se recomienda que un montador de muebles profesional realice el montaje del producto con un destornillador eléctrico.

AVISO: Não nos comprometemos pelo mal-uso, montagem e fixação do produto à parede. Portanto, não somos responsáveis por danos e quedas do produto, eletrônicos e pertences neles contidos. É importante o uso de brocas e ferramentas compatíveis na montagem.
NOTICE: The company is not responsible for the misuse, assembly, and wall fixation, as well as the damages and falls that the products, electronics, and belongings therein might suffer. It is important to use suitable drills and tools to assemble the product.
ATENCIÓN: La empresa no se responsabiliza del mal uso, montaje y fijación del producto a la pared, así como de daños y caídas del producto, electrónicos u objetos. Es importante el uso de taladros y herramientas compatibles con el montaje.

Dica: para evitar possíveis avarias, use a embalagem do produto como apoio durante a montagem.
Tip: to avoid damages, use the product packaging as a base during the assembly.
Pista: para evitar daños, use el envase del producto como apoyo durante el montaje.

RELAÇÃO DE FERRAGENS | HARDWARE LIST | LISTADO DE HERRAJES

BUCHA GESSO 10mm	(A)	10mm DRYWALL ANCHOR	(A)	TACO PARA YESO 10 mm	(A)		04
CONECTOR 2 FUROS	(B)	2-HOLE CORNER BRACKET	(B)	SOPORTE ANGULAR 2 AGUJEROS	(B)		03
PARAFUSO 3,5x35	(C)	3.5x35 SCREW	(C)	TORNILLO 3,5x35	(C)		18
PARAFUSO 4x25	(D)	4x25 SCREW	(D)	TORNILLO 4x25	(D)		30
PARAFUSO 3,5x14 FLANG.	(E)	3.5x14 FLANGE SCREW	(E)	TORNILLO TIPO FLANGE 3,5x14	(E)		06
PARAFUSO 7x60	(F)	7x60 SCREW	(F)	TORNILLO 7x60	(F)		04
SACHÊ DE COLA	(G)	GLUE SACHET	(G)	BOLSITA DE PEGAMENTO	(G)		01

RELAÇÃO DE PEÇAS | PARTS LIST | LISTADO DE PARTES

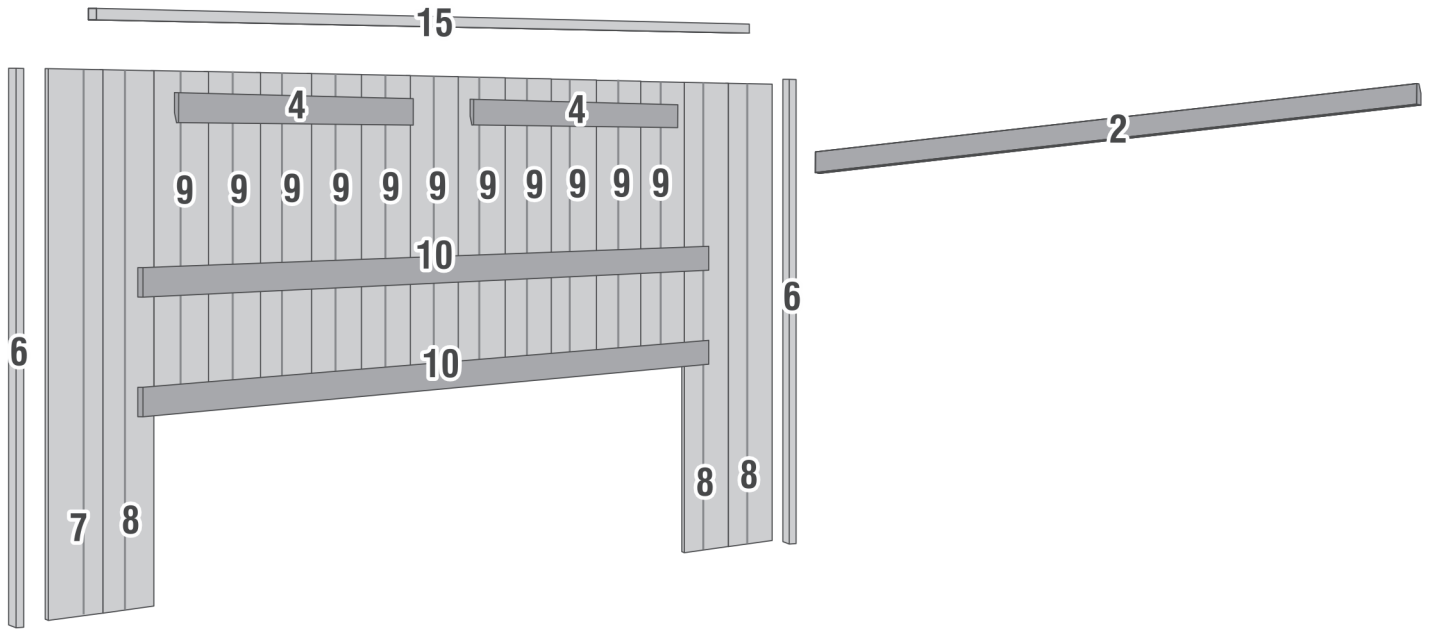

10
RÉGUA SUPORTE
LOWER SUPPORT
SOPORTE INFERIOR 2PCS
2PCS
2PZAS



2
RÉGUA PAREDE
WALL MOUNT
SOPORTE DE PARED 1PC
1PC
1PZA



4
RÉGUA REBAIXADA
TOP SUPPORT
SOPORTE SUPERIOR 2PCS
2PCS
2PZAS



15
CHAPÉU
TOP
TAPA 1PC
1PC
1PZA



7
RIPADO DIREITO
RIGHT SLAT
LISTÓN DERECHO 1PC
1PC
1PZA



8
RIPADO ESQUERDO
LEFT SLAT
LISTÓN IZQUIERDO 3PCS
3PCS
3PZAS



6
RÉGUA LATERAL
VERTICAL SLATS
SOPORTES VERTICALES 2PCS
2PCS
2PZAS



9
RIPADO MENOR CENTRAL
MIDDLE SLATS
LISTONES CENTRALES 11PCS
11PCS
11PZAS

Passo 01 PARAFUSE AS PEÇAS 6 NAS PEÇAS 7 E 8 COM PARAFUSO 3,5x35 (C).
 Step 01 ATTACH PARTS 6 TO PARTS 7 AND 8 WITH 3.5x35 SCREWS (C).
 Paso 01 FIJE LAS PARTES 6 A LAS PARTES 7 Y 8 CON TORNILLOS 3,5x35 (C).

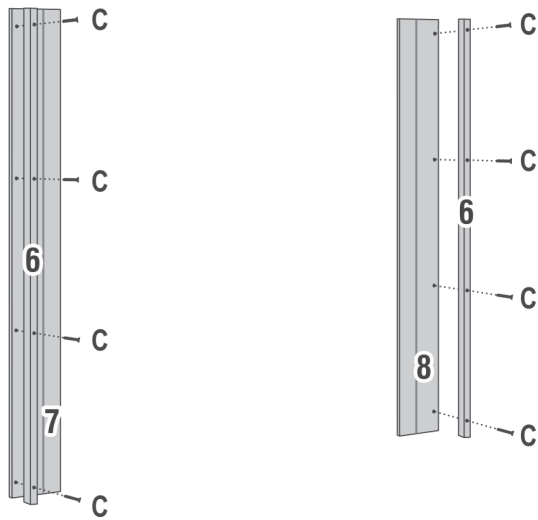

VISTA TRASEIRA
 BACK VIEW
 VISTA TRASERA



Passo 02 FAÇA A UNIÃO DAS PEÇAS 7, 8 E 9.
 Step 02 PUT PARTS 7, 8, AND 9 TOGETHER.
 Paso 02 UNA LAS PARTES 7, 8 Y 9.

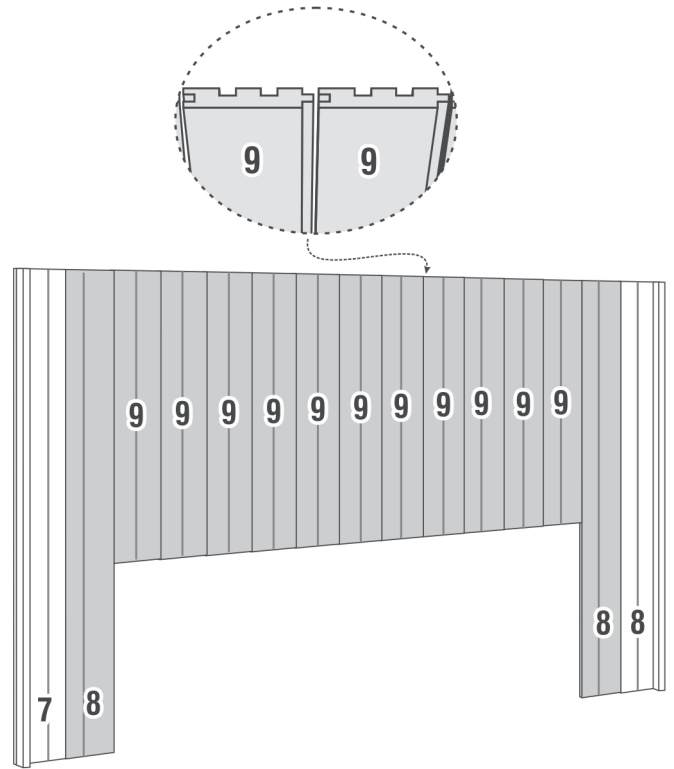

VISTA TRASEIRA
 BACK VIEW
 VISTA TRASERA

Passo 03 PARAFUSE AS PEÇAS 10 NAS PEÇAS 7, 8 E 9 COM PARAFUSO 4x25(D), SEGUINDO AS LINHAS DEMONSTRATIVAS.
 Step 03 FOLLOW THE MARKS TO ATTACH PARTS 10 TO PARTS 7, 8, AND 9 WITH 4x25 SCREWS (D).
 Paso 03 OBSERVE LAS MARCACIONES PARA FIJAR LAS PARTES 10 A LAS PARTES 7, 8 Y 9 CON TORNILLOS 4x25 (D).

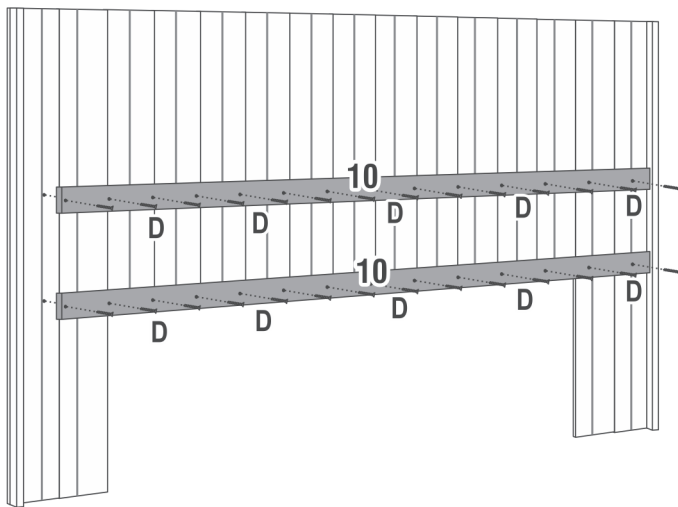

VISTA TRASEIRA
 BACK VIEW
 VISTA TRASERA



Passo 04 PARAFUSE AS PEÇAS 4 NAS LINHAS DEMONSTRATIVAS COM PARAFUSO 3,5x35 (C), USANDO COLA (G) NELAS.
 Step 04 APPLY GLUE (G) TO PARTS 4 AND FASTEN THEM TO THE MARKS WITH 3.5x35 SCREWS (C).
 Paso 04 SEGÚN LAS MARCACIONES, APLIQUE PEGAMENTO (G) A LAS PARTES 4 Y FIJELAS CON TORNILLOS 3,5x35 (C).

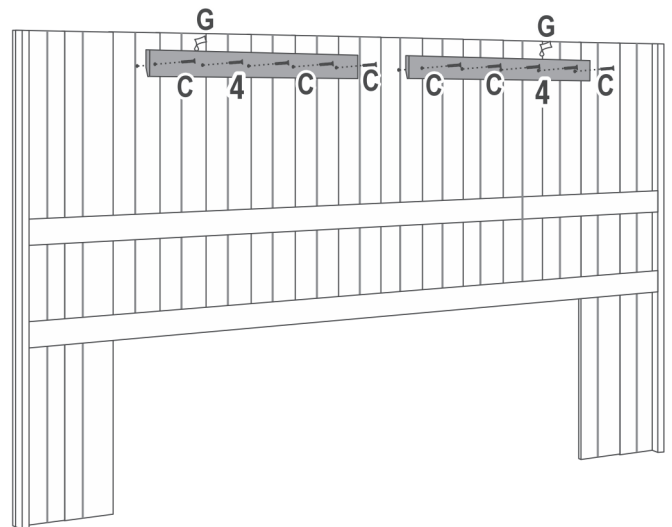

VISTA TRASEIRA
 BACK VIEW
 VISTA TRASERA



Passo 05 COM A CABECEIRA DE PÉ, PARAFUSE A PEÇA 15 ALINHADA COM AS PEÇAS 6 COM CONECTOR 2 FUROS (B+E).

Step 05 WITH THE HEADBOARD UPRIGHT, ALIGN PART 15 WITH PARTS 6 AND FASTEN THEM WITH 2-HOLE CORNER BRACKET (B+E).

Paso 05 CON LA CABECERA DE PIE, ALINEE LA PARTE 15 CON LAS PARTES 6 Y FIJELAS CON SOPORTES ANGULARES 2 AGUJEROS (B+E).

ATENÇÃO: ALINHE A PEÇA 5 COM AS PEÇAS 6 PARA PARAFUSAR.
NOTE: ALIGN PART 5 WITH PARTS 6 BEFORE FASTENING THEM.
¡ATENCIÓN! ALINEE LA PARTE 5 CON LAS PARTES 6 ANTES DE ATORNILLAR.

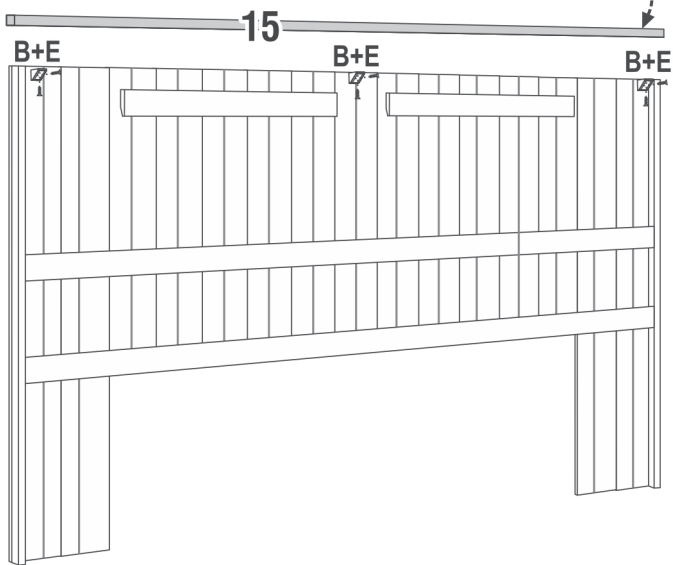

VISTA TRASEIRA
BACK VIEW
VISTA TRASERA

B = 3 

E = 6 

Passo 06 PARAFUSE A PEÇA 2 NA PAREDE COM PARAFUSO 7x60 (F) E BUCHA GESSO 10mm (A).

Step 06 SCREW PART 2 TO THE WALL WITH 7x60 SCREWS (F) AND 10mm DRYWALL ANCHORS (A).

Paso 06 ATORNILLE LA PARTE 2 A LA PARED CON TORNILLOS 7x60 (F) Y TACOS PARA YESO 10 mm (A).

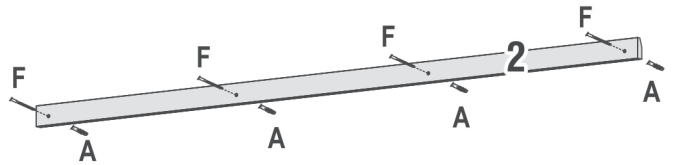

A = 4 

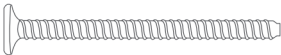
F = 4 

Passo 07 INSTALE A CABECEIRA, ENCAIXANDO NA PEÇA 2 JÁ FIXADA NA PAREDE.

Step 07 MOUNT THE HEADBOARD TO THE WALL BY ALIGNING IT WITH PART 2.

Paso 07 ALINEE LA CABECERA Y ENCÁJELA EN LA PARTE 2.

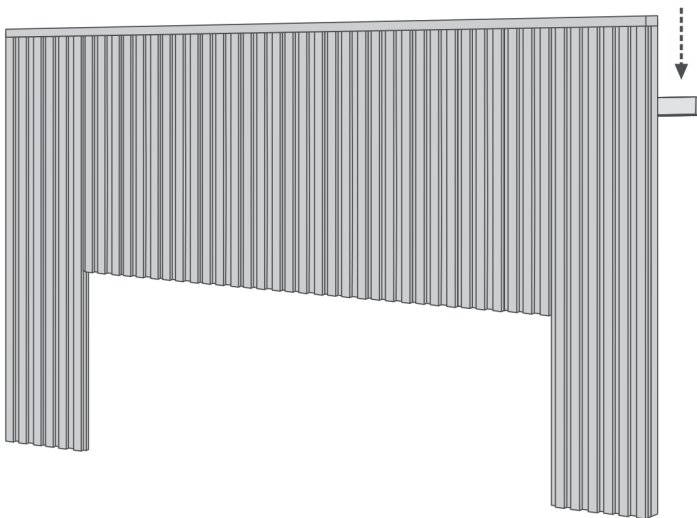

Passo 08 PRODUTO MONTADO.

Step 08 PRODUCT ASSEMBLED.

Paso 08 PRODUCTO ARMADO.

