



# BANCADA RETRÔ 50

DIMENSÕES DO PRODUTO / DIMENSIONS PRODUCT L/WxP/DxA/H - 1620x388x574 MM

ATENÇÃO: VÍDEO DE MONTAGEM DISPONÍVEL NO SITE

[www.olivar.com.br](http://www.olivar.com.br)

**ATENÇÃO**  
ESTE PRODUTO NÃO PODE  
SER ARRASTADO

OBS: TODAS AS PEÇAS SÃO NUMERADAS.

EX: 1915X-X 20 (nº da peça)

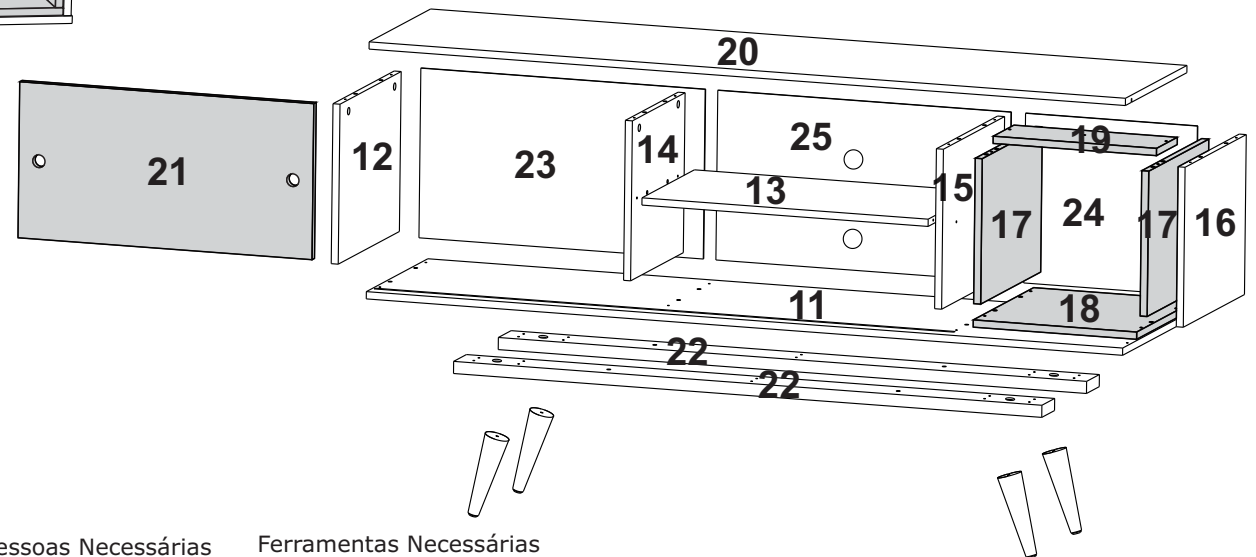
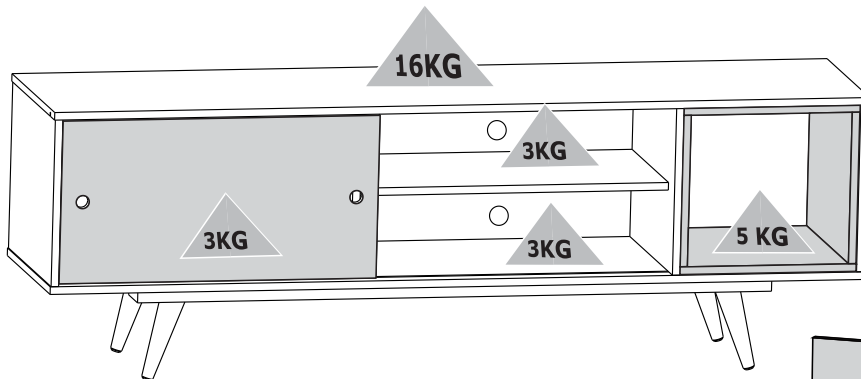

SETUP THE PRODUCT ON TOP OF THE PACKAGING, AVOIDING  
DAMAGE TO THE PAINT.

MONTAR O PRODUTO SOBRE A EMBALAGEM,  
EVITANDO DANOS NA PINTURA.



## CUIDADOS ESPECIAIS

**LIMPEZA-** Pano limpo umedecido em água e sabão neutro.  
**BRILHO-** Flanela seca.

### SPECIAL CARE

**CLEANING-** Dampened cloth with water and mild soap.  
**POLISH-** Dry flanned.

### ATENÇÃO

Nunca utilizar óleos, como lustra móvel; produtos  
abrasivos, como saponáceos, esponja de aço e outros.

### ATTENTION

Never use oils or abrasive products.

Pessoas Necessárias  
para Montagem



1 pessoa

Ferramentas Necessárias  
(Não Fornecidas)

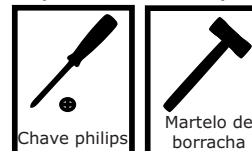

Chave philips

Martelo de  
borracha

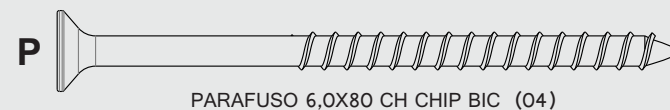
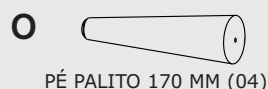
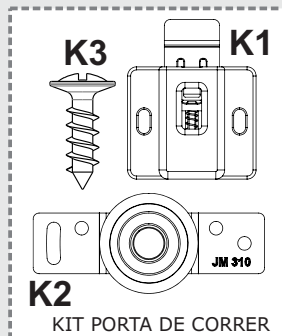
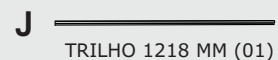
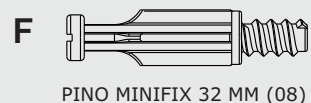
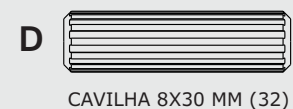
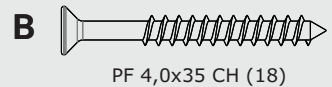
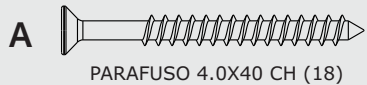

ITEM	DESCRIÇÃO DAS PEÇAS					CORES					
	COD	Nº	NOME	MEDIDAS	TIPO	QUANT	BCO	PTO	TURQ	AMAR	RUSTIK
10142	11	BASE	1620X385X15	MDP	01	11/05	11/07				11/24
10143	12	LATERAL ESQUERDA	383X330X15	MDP	01	12/05	12/07				12/24
10144	13	PRATELEIRA	613X328X15	MDP	01	13/05	13/07				13/24
10145	14	DIVISOR ESQUERDO	330X330X15	MDP	01	14/15	14/07				14/24
10146	15	DIVISOR DIREITO	383X330X15	MDP	01	15/05	15/07				15/24
10147	16	LATERAL DIREITA	383X330X15	MDP	01	16/05	16/07				16/24
10148	17	LATERAL ESQ.DIR NICHOS	376X300X15	MDP	02	17/05	17/07	17/21	17/23		17/24
10149	18	BASE NICHOS	378X350X15	MDP	01	18/05	18/07	18/21	18/23		18/24
10150	19	TAMPO NICHOS	350X130X15	MDP	01	19/05	19/07	19/21	19/23		19/24
10151	20	TAMPO SUPERIOR	1620X385X15	MDP	01	20/05	20/07				20/24
10152	21	PORTA DE CORRER	630X322X15	MDF	01	21/05	21/07	21/21	21/23		21/24
10208	22	REFORÇO PÉ	1250X80X25	MDF	02	22/05	22/07				22/24
10153	23	FUNDO ESQUERDO	609X350X3	TRI	01	23/05	23/07				23/24
10154	24	FUNDO DIREITO	368X350X3	TRI	01	24/05	24/07				24/24
10207	25	FUNDO CENTRAL	628X350X3	TRI	01	25/05	25/07				25/24
438	A	Parafuso 4,0x40 CH				18					
437	B	Parafuso 4,0x35 CH				18					
434	C	Parafuso 4,0x25 CH				01					
137	D	Cavilha 8x30 MM				32					
2921	E	Cavilha 8x20 MM				01					
532	F	Pino Minifix 32 MM				08					
508	G	Tambor de Minifix 15 MM				08					
509	H	Tampa de Minifix				06	BCO	PTO			CAFÉ
7687	I	Tapa Furo 8 MM				02	BCO	PTO			CAFÉ
10371	J	Trilho 1218 MM				01	BCO	PTO			CAFÉ
9002	K	Kit porta de correr				01					
248	L	Prego 8x8 MM				60					
911	M	Garra de Aço				10					
3441	N	Amortecedor				04					
11818							MEL				
11819	O	Pé Palito madeira 170 MM C/ FURO				04					CAST
11723							MOGNO				
11710	P	Parafuso 6,0X80 CH CHIP BIC				04					
		Certificado Garantia				01					

### FIXAÇÃO: PINO E TAMBOR DE MINIFIX

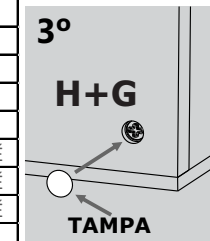
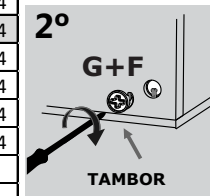
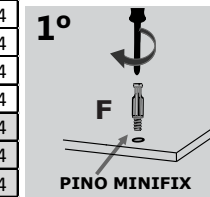

### FIXAÇÃO DA PORTA DE CORRER / FIXING THE SLIDING DOOR

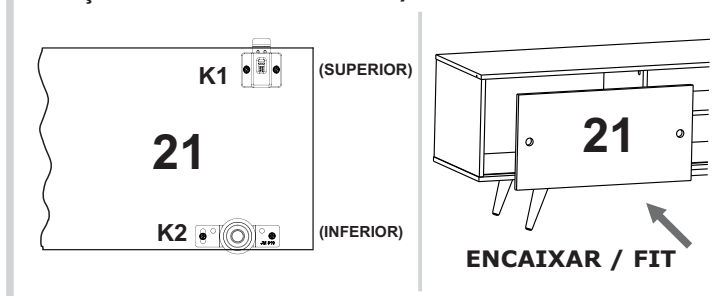

1

OBS: AS CORES APRESENTADAS NOS PASSOS SÃO MERAMENTE ILUSTRATIVAS.

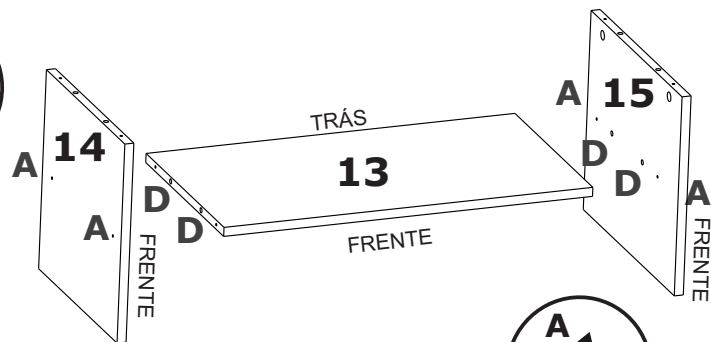
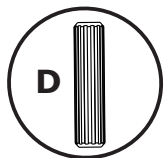

A=04  
D=04

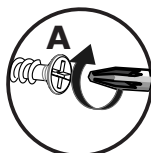

2

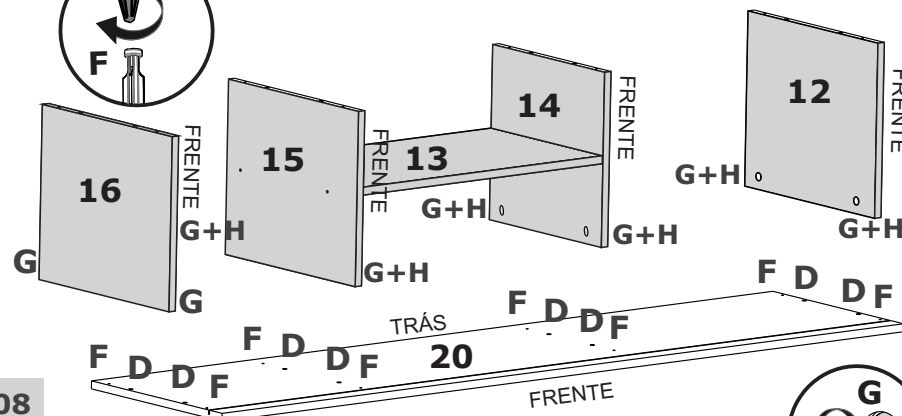
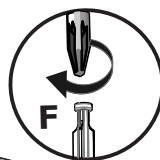

D=08  
F=08  
G=08  
H=06

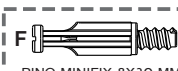

3

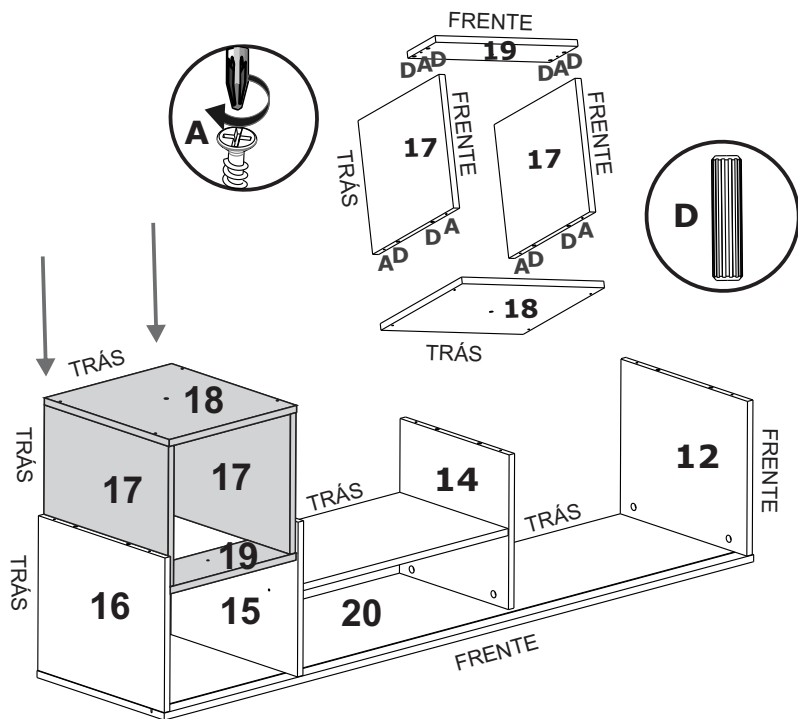

A=06  
D=08

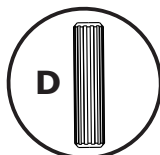

4

USAR MARTELO DE BORRACHA

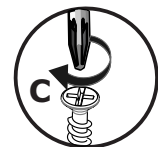
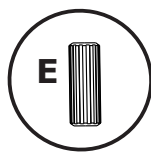
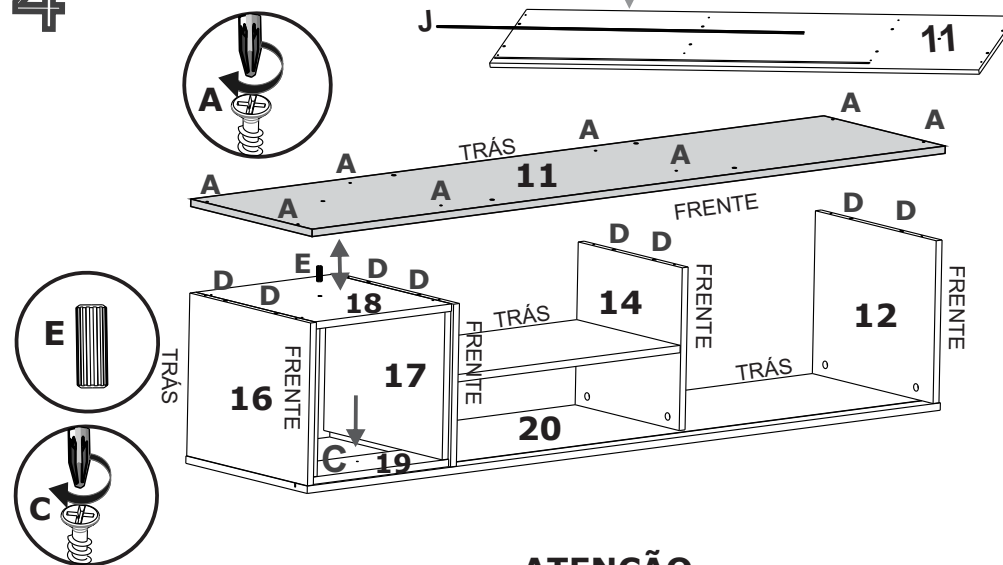

A=08  
C=01  
D=08  
E=01  
J=01

ATENÇÃO

OBS: ENCAIXAR A CAVILHA MENOR (E) COM CUIDADO NAS PEÇAS 11 E 18. DEPOIS PARAFUSAR A PEÇA 19 NA 20 COM O PARAFUSO 4,0X25.

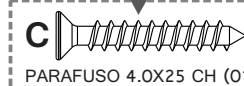

5

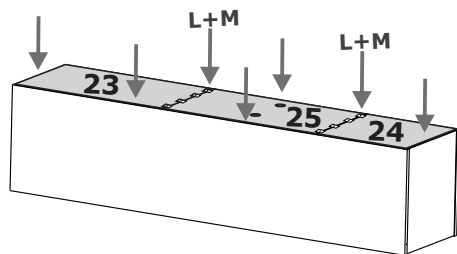

L=10  
M=60



GARRA DE AÇO



PREGO 8X8 MM

6

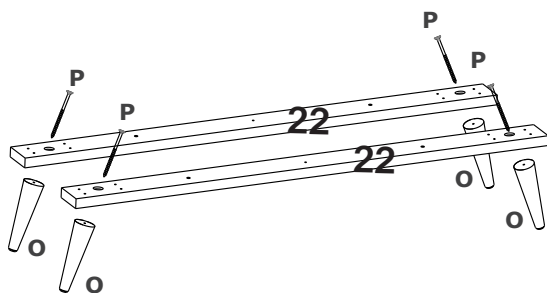

O=04  
P=04

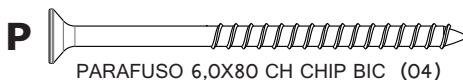

PARAFUSO 6,0X80 CH CHIP BIC (04)

FIXAÇÃO DO PÉ

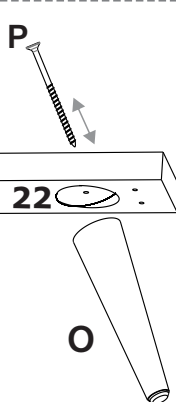

7

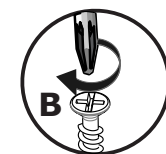
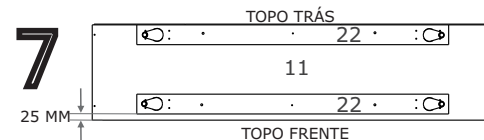

BORDA COLORIDA PARA FRENTE

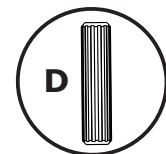

B=18  
D=04  
I=02

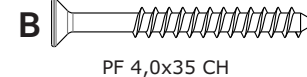

PF 4,0x35 CH

**ATENÇÃO**  
UMA DAS PEÇAS 22 COLOCAR FACEANDO NO TOPO DE TRÁS DA PEÇA 11 COM A BORDA COLORIDA PARA TRÁS.  
A OUTRA PEÇA 22 COLOCAR À UMA DISTÂNCIA DE 25 MM DA BORDA DA FRENTE DA PEÇA 11 COM A BORDA COLORIDA PARA FRENTE.

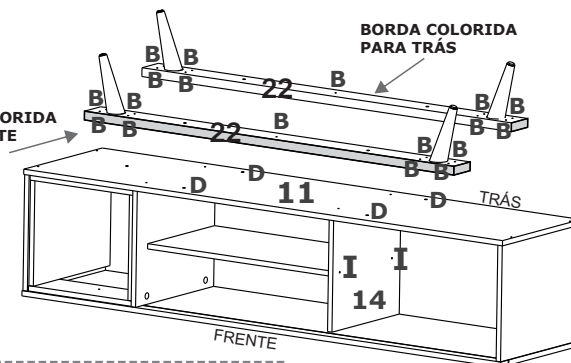

TAPA FURO PL 8 MM

8

ATENÇÃO

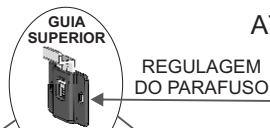

REGULAGEM DO PARAFUSO



FIXAÇÃO

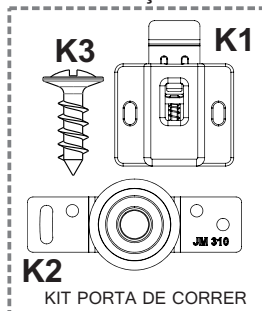

KIT PORTA DE CORRER

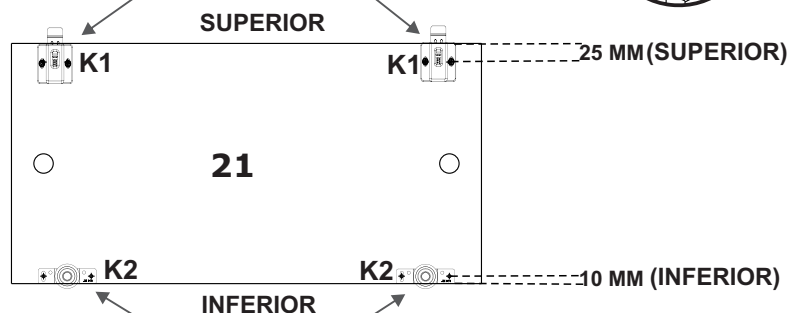
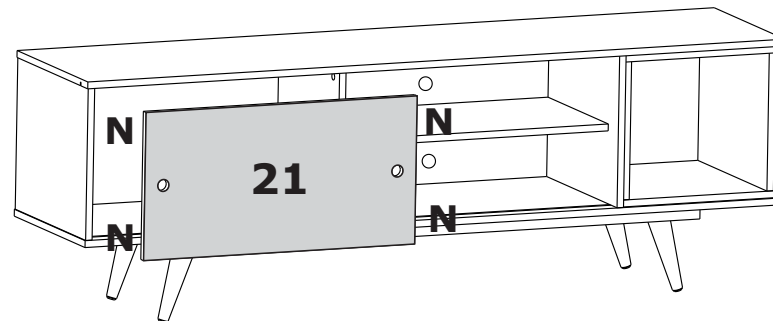

K=01  
N=04

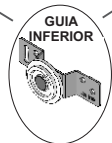

N  
AMORTECEDOR POLIURETANO

