

# ME 4123

## Instruções de Montagem Instrucciones de Montaje

Acesse Vídeos de Montagens  
[www.tecnomobili.ind.br](http://www.tecnomobili.ind.br)

**tecnomobili**

Estrada RSC 453, Km s/n° | Garibaldi | RS  
CEP: 95720-000 | Fone / Fax: 54.3464.2050  
sac@moveisvideira.com.br

### Notas especiais:

**01** - Examine completamente todas as peças do móvel antes de iniciar o trabalho.

**02** - Recomenda-se montar o móvel conforme este Manual de Montagem.

**03** - É de responsabilidade do montador seguir as instruções do Manual de Montagem, que são fundamentais para garantir a estrutura do móvel.

**04** - Para limpeza utilizar somente pano úmido e sabão neutro.

### Notas especiales:

**01** - Examine completamente todas las piezas del mueble antes de iniciar el trabajo.

**02** - Se recomienda montar el mueble conforme el Manual de Esablaje.

**03** - Es de responsabilidad del montador seguir las instrucciones del Manual de Ensamblaje, que son fundamentales para garantizar la estructura del mueble.

**04** - Para limpieza solamente usar trapo húmedo y jabón neutro.

### Certificado de garantia:

A garantia dos produtos fabricados pela Móveis Videira LTDA, abrange eventuais defeitos/vícios de fabricação, no prazo estabelecido pelo Código de Defesa do Consumidor, em seu artigo 26,II, o qual prevê a garantia legal de 90 (noventa) dias.

### Ferramentas | Herramientas

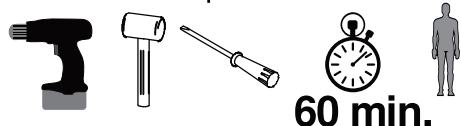







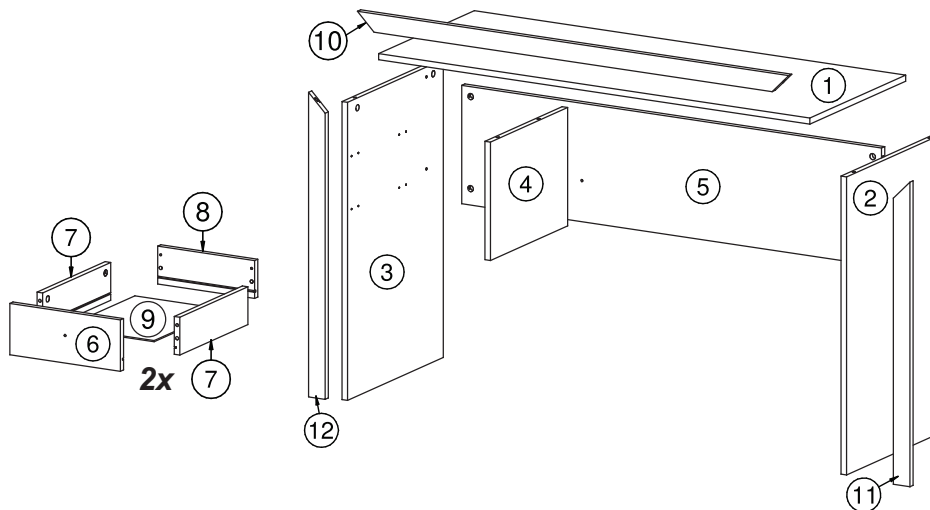

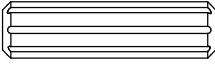
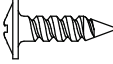



60 min.

### Lista de peças / Lista de piezas

CÓD	DESCRIÇÃO	QTD	M. PRIMA	DIMENSÕES
01	Tampo	1	MDP 15mm	1170x450x15
02	Lateral Direita	1	MDP 15mm	725x450x15
03	Lateral Esquerda	1	MDP 15mm	725x450x15
04	Divisão	1	MDP 15mm	363x288x15
05	Costa	1	MDP 15mm	1139x288x15
06	Frente Gaveta	2	MDP 15mm	125x300x15
07	Lateral Gaveta	4	MDP 15mm	320x92x15
08	Costa Gaveta	2	MDP 15mm	263x92x15
09	Fundo Gaveta	2	Chapa Dura 3mm	329x242x15
10	Travessa Frontal	1	MDP 15mm	1170x45x15
11	Travessa Direita	1	MDP 15mm	741x45x15
12	Travessa Esquerda	1	MDP 15mm	741x45x15

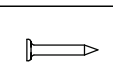

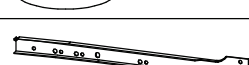
REF	DESCRIÇÃO	QTD
A	 Cavilha 8 x 30mm	08
B	 Parafuso 3,5 x 14mm CF	20
C	 Parafuso 3,5 x 16mm CC	24
D	 Parafuso 3,5 x 30mm CP	02
E	 34x7mm Parafuso minifix	19
F	 15x12mm Tambor minifix	23
G	 38x38mm Minifix haste dupla	02
H	 OU  22x17x12mm Suporte angular	10
I	 40x20x21mm Puxador	02
J	 32x45x20mm Distanciador de corredeira	04
K	 22x3mm Prego 10 x 10mm	04
L	 14x4mm Sapata deslizadora	04
M	 Corredeira 350mm	02

Revisão: 00  
Data: 25/01/2016

