













	CÓD.	FERRAGEM	QTDE.
A	1260	 7,0X70	02
B	8020	 7,0X130	04
C	4367	 1/4X130	04
D	1802	 CAVILHA 6x30	05
E	4164	 PORCA ELIPTICA	08
F	248	 CHAVE ALLEN	01
G	107	 PREGOS 10X10	42
H	4191	 TAMPA P/ ESTRUTURAL TABACO	14
H	1493	 TAMPA P/ ESTRUTURAL BRANCO	14
H	8170	 TAMPA P/ ESTRUTURAL TECA ITALIA	14
H	14978	 TAMPA P/ ESTRUTURAL CARVALLE	14
I	58	 kappesberg	01
J	4214	 3,5x14 CHATO	02

L	85	 "L" DE METAL	01
M	8572	 SARRA 100 X 100 TECA ITALIA	02
M	15507	 SARRA 100 X 100 CARVALLE	02
M	8021	 SARRA 100 X 100 BRANCO	02
M	8022	 SARRA 100 X 100 TABACO	02
N	4190	 1/4X70	04
O	149	 PREGOS 13x15	02
P	1901	 SAPATA DESLIZADORA PRETA	02
Q	22151	 LASTROS 70x5x1	20
R	1318	 TRAVESSAS	04
S	12348	 SUPORTE PARA LASTRO	08
T	5256	 CHATO 4,0X20	48

"GARANTIA POR DEFEITO DE FABRICAÇÃO 3 MESES."

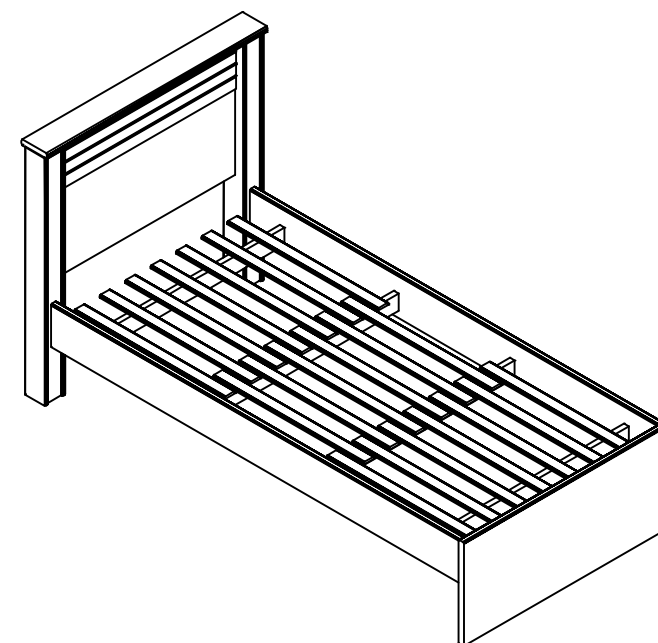

12817-TRAVESSA DA CABECEIRA
12818-LATERAL DA CAMA
12819-PEÇA LARGA DA CABECEIRA
12820-PEÇA ESTREITA DA CABECEIRA
12821-PESEIRA
12822-PEÇA MENOR DO PÉ ALTO
12823-PEÇA MAIOR DO PÉ ALTO EXTERNA
12824-PEÇA MAIOR DO PÉ ALTO INTERNA

↑
"OBS: Para solicitar assistência técnica, utilize o código da ferragem indicada."

←
"OBS: Para solicitar assistência técnica, utilize o código das peças indicada."

OBS.: COLOCAR 1 "L" DE METAL NA CABECEIRA PARA FIXAR A TRAVESSA

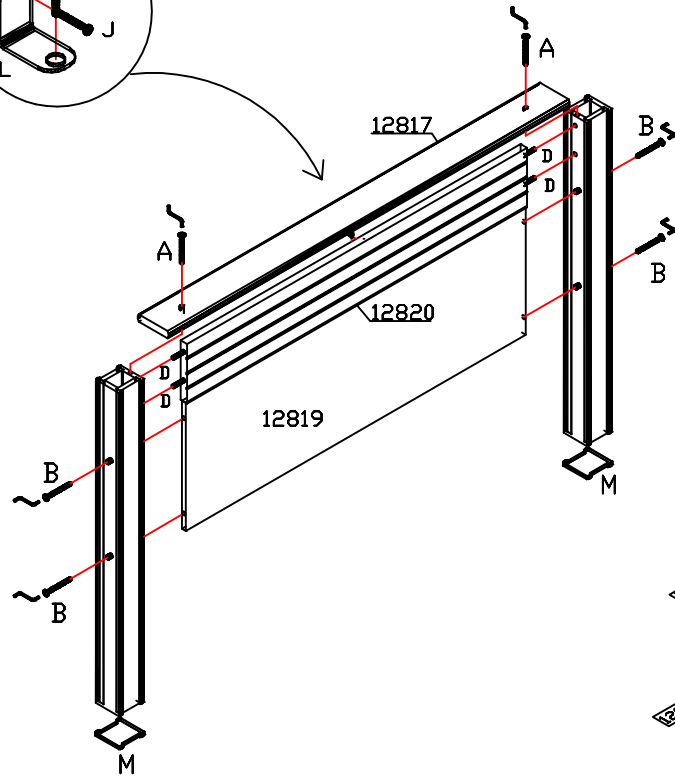
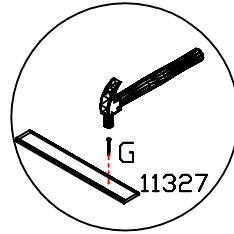
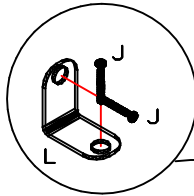

DETALHE DA MONTAGEM DA CABECEIRA

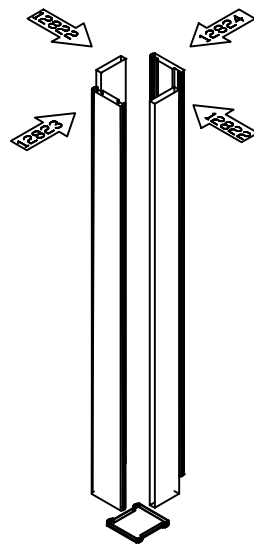

DETALHE DA MONTAGEM DOS PÉS

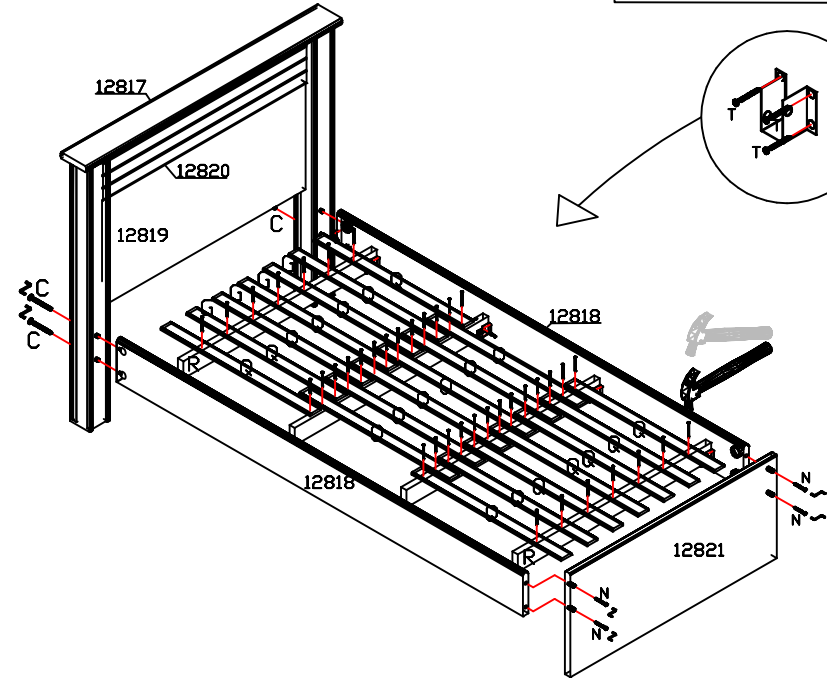

FIXAR O APOIO DO LASTRO "S" NA LATERAL DA CAMA COM O PARAFUSO "T" E EM SEGUIDA FIXAR O LASTRO NO APOIO.

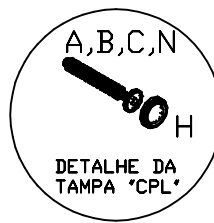
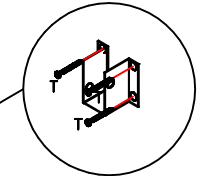

DETALHE DA TAMPA "CPL"

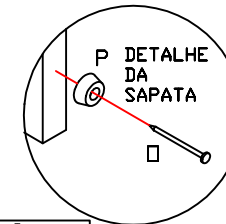

DETALHE DA SAPATA

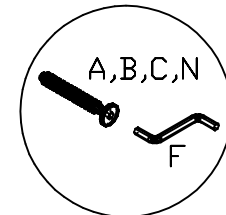

A, B, C, N

F