

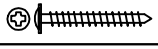

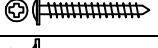

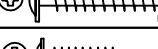

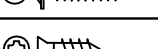





|   | CÓD.  | FERRAGEM  | QTDE |
|---|-------|---|------|
| A | 2592  |  ZINCADO BRANCO 4,0x40       | 16   |
| A | 4404  |  BRANCO 4,0x40               | 16   |
| A | 4042  |  PRETO 4,0x40                | 16   |
| B | 95    |  FLANGEADO 5,0x50            | 01   |
| C | 14773 |  3,5x25                      | 04   |
| D | 4214  |  3,5x14                      | 14   |
| E | 4207  |  PARAFUSO / DOBRADIÇA 3,0x14 | 24   |
| F | 4207  |  DOBRADIÇA 26MM              | 06   |
| G | 4207  |  CALÇO 3MM                   | 06   |
| H | 1802  |  CAVILHA 6x30                | 38   |
| I | 1901  |  SAPATA DESLIZADORA PRETA    | 04   |
| J | 7981  |  PUXADOR                     | 02   |
| K | 41    |  COLA BRANCA               | 01   |
| L | 107   |  PREGOS 10x10              | 87   |
| M | 149   |  PREGOS 13x15              | 05   |
| N | 529   |  BUCHA 8MM                 | 01   |
| O | 85    |  'L' DE METAL              | 04   |
| P | 568   |  'L' PLÁSTICO              | 01   |
| Q | 58    | <b>kappesberg</b>   | 01   |

**kappesberg** móveis  
www.kappesberg.com.br

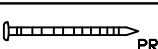
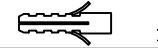
Rua da Emancipação 2000 - TUPANDI - RS  
FONE (051) 3635-8800  
www.kappesberg.com.br

REF.: S4008

RELAÇÃO DE PEÇAS

17904-LATERAL ESQUERDA  
17905-LATERAL DIREITA  
17906-BASE  
17907-CHAPÉU  
17908-RODAPÉ  
17909-PRATELEIRA  
17910-RODAFORRO  
17911-PORTA  
17912-COSTA

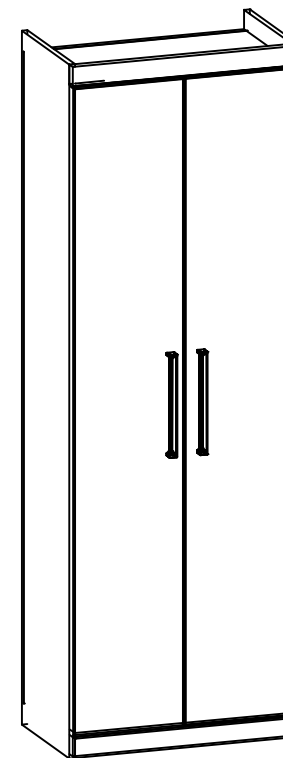

⚠️ OBS: Para solicitar assistência técnica, utilize o código das peças indicada.

"GARANTIA POR DEFEITO DE FABRICAÇÃO DE 3 MESES."

“OBS: Para prender o móvel na parede, prenda o suporte plástico “P” no chapéu, com os parafusos “D” e depois na parede com o parafuso “B” e bucha “N”.

### 1º PASSO

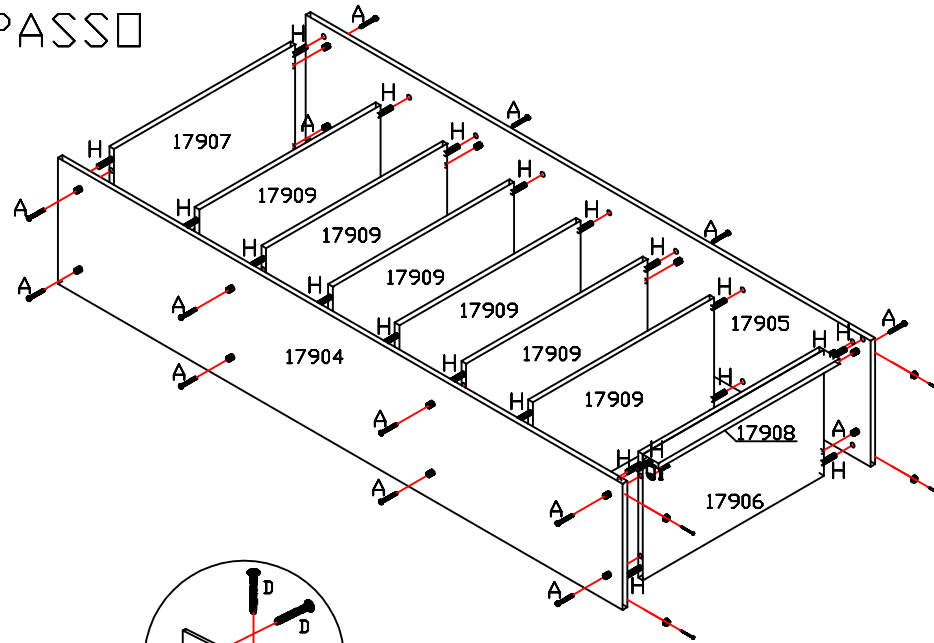

“OBS: Prender o rodaforno com dois “L” de metal.

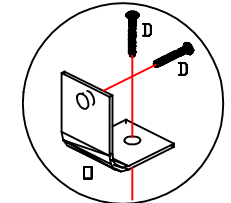

“L” DE METAL

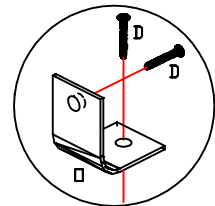

“L” DE METAL

“OBS: Prender o rodapé com dois “L” de metal.

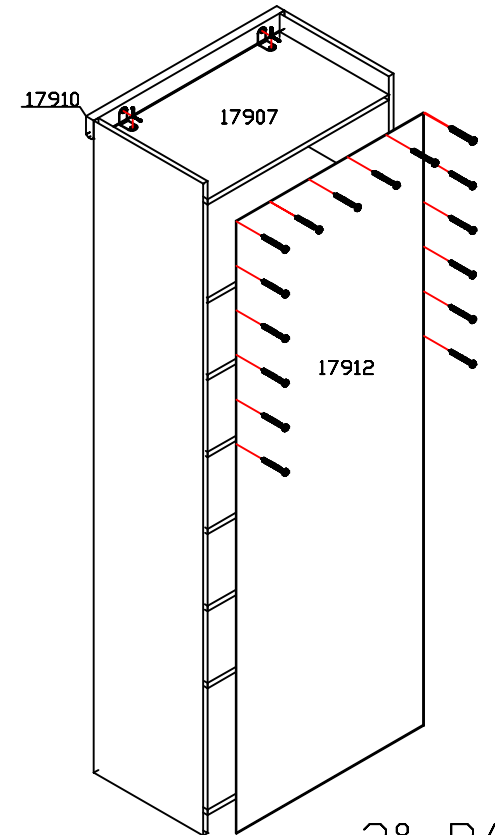
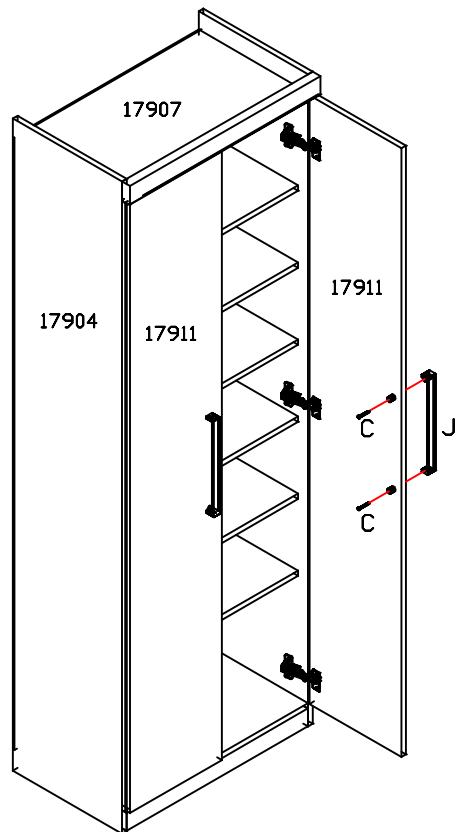
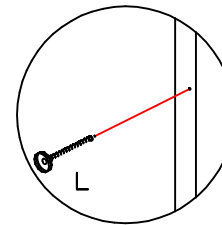
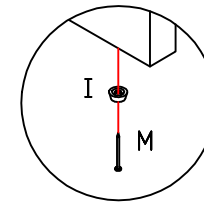

### 2º PASSO

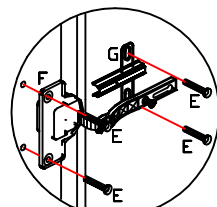

DOBRADIÇA

### 3º PASSO