

Kappesberg

www.kappesberg.com.br

Móveis





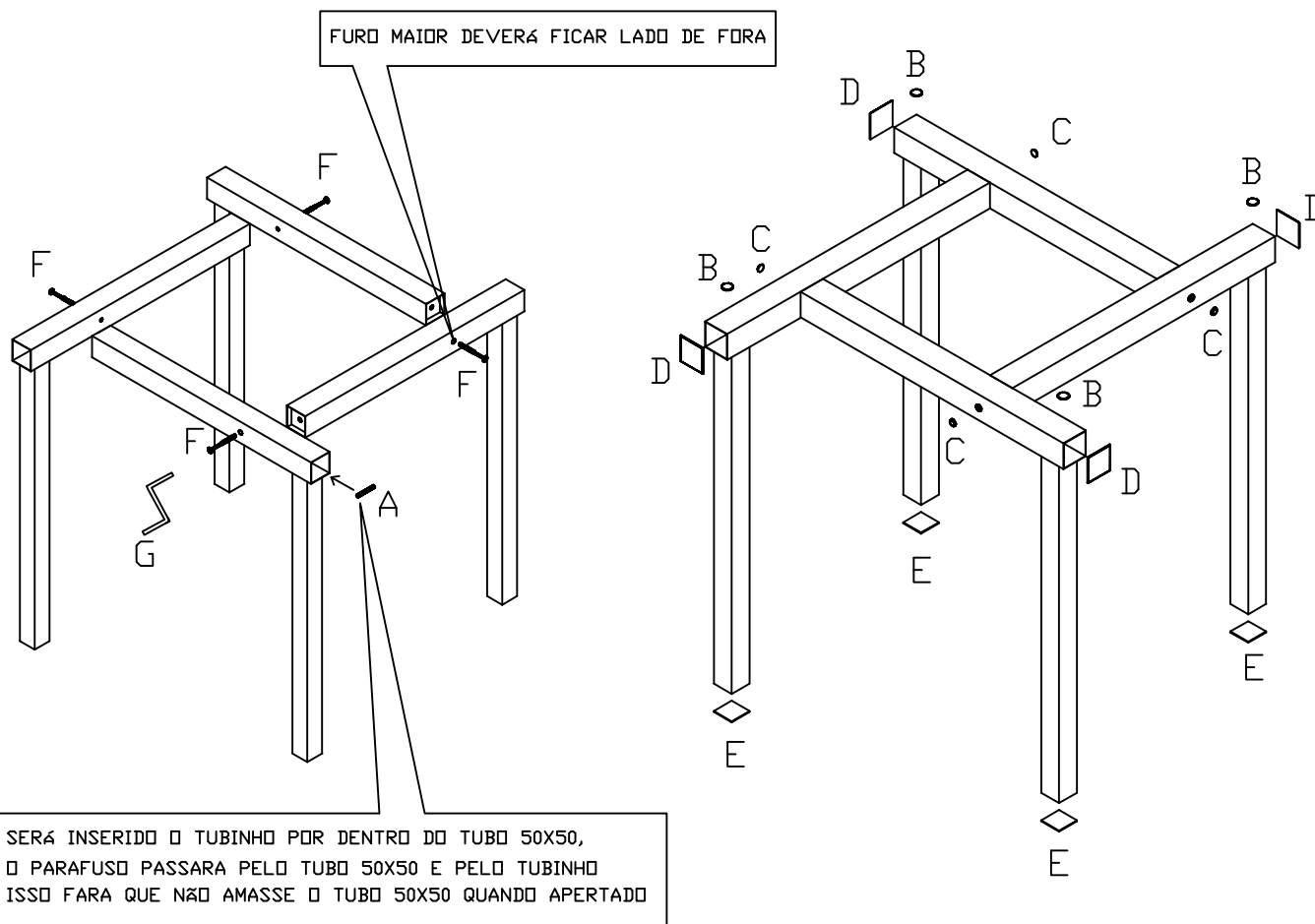

RUA DA EMANCIPAÇÃO Nº2000 - TUPANDI-RS

Fone (51)3635-8800

Ref.: M032CR

Obs: para assistência.Favor solicitar o numero ou cód. do item

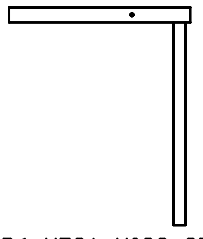

	cód.	descrição	Quant.
A	031994	 AFASTADOR DIAM. 10X47 P/ MESA M032	04
B	009623	 batente de silicone 19mm	04
C	009594	 TAMPA CPL CROMADA 12,5 A 13MM	04
D	031329	 PONT. INT. 50X50 1.06-1.20 CR	04
E	009593	 40X40 PRETA	04
F	004410	 PESTRUTURAL 1/4X80 C/G CAB 13 ALLEN	04
G	000248	 CHAVETA ALLEN ZETA 1/4mm	01
H	A109	 PÉ MESA M032-CR	04

Cuidados com a conservação do cromado:

- *Limpar somente com pano seco (flanela)
- *Evitar limpar com água, pois pode ocorrer o acúmulo de líquido em regiões específicas da peça.
- *Não utilizar produtos de limpeza que possuem cloro em sua formação.
- *Encerar no mínimo 1 vez por mês, com cera de base de silicone 1.