

Medidas são externas e podem variar mais ou menos 10mm

PRODUTOS NÃO PODEM MOLHAR NEM SER EXPOSTOS AO SOL OU EM LUGARES ÚMIDOS

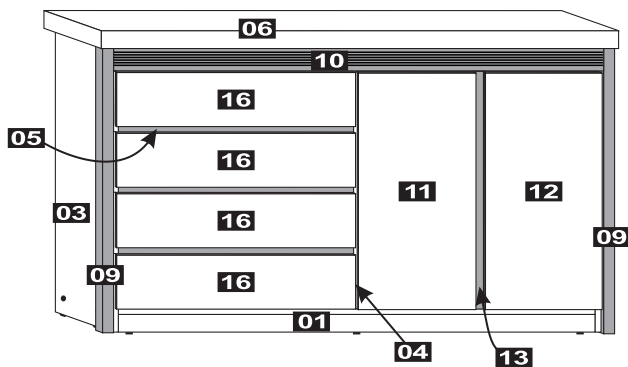

Limpar com pano seco, não usar produtos químicos, abrasivos ou pontiagudos

FRONTÃO  
LADO FRISADO



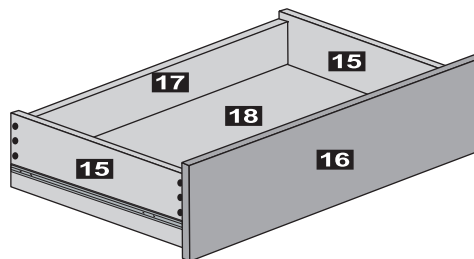
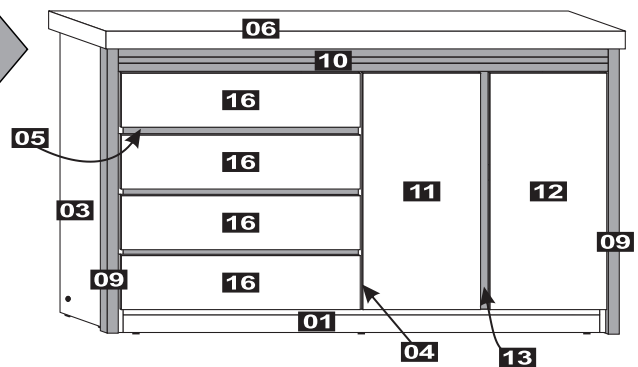











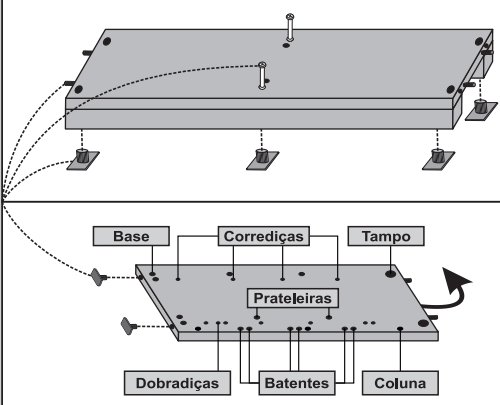
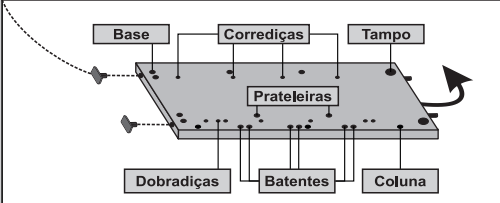

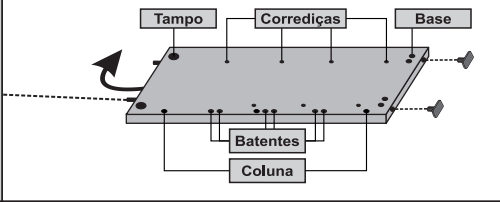

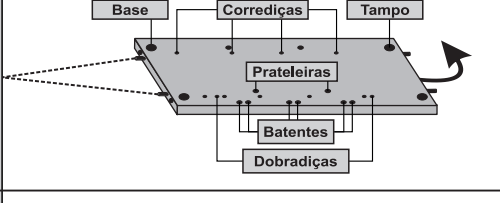
FRONTÃO  
LADO FRISO / MOLD

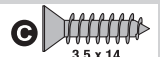



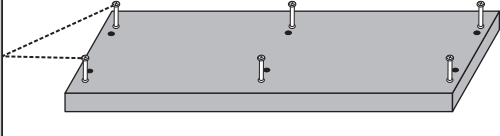

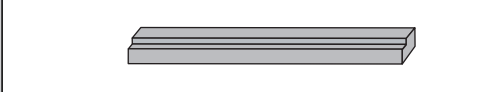
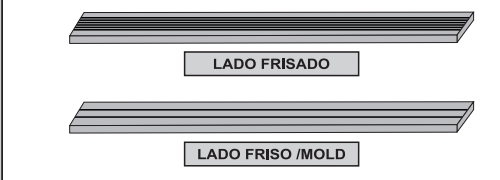

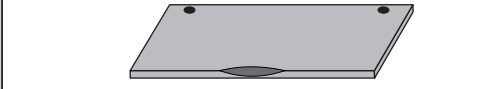

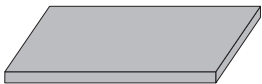
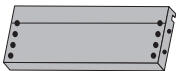
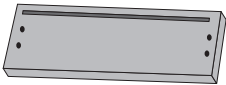

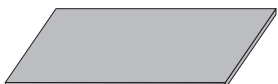

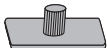

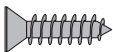

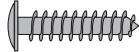

SEQ.	Q2 VOLUMES	DESENHO DOS VOLUMES	MEDIDA A x L x C	M <sup>3</sup>	PESO	CÓDIGO
1/2	BASE					10524
2/2	GAVETA					10703
<b>TOTAL</b>						

MEDIDAS SÃO EXPRESSAS EM MM - PESO EM KG - VOLUME EM M<sup>3</sup>

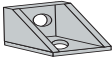
Dependendo do fornecedor de chapas de MDF, o peso pode variar.

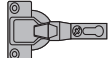
FIXAR AS FERRAGENS	DESENHO DAS PEÇAS	ORD.	QTD.	NOME DA PEÇA	MEDIDA (mm)	MDF (mm)	ESTÁ NO VOLUME	CÓDIGO
<b>FIXAR SAPATAS E CAVILHAS NA BASE E LATERAIS</b>   		01	01	BASE CO-1385 /410	1385 x 410	15	BASE	10348
		02	01	LATERAL DIREITA CO-1015 /410	1015 x 410	15	BASE	10336
 		03	01	LATERAL ESQUERDA CO-1015 /410	1015 x 410	15	BASE	10337
		04	01	DIVISÃO CO-975 /405	975 x 405	15	BASE	07531
  		05	03	BATENTE GAVETA CO-685 /55	685 x 55	15	GAVETA	10349
		06	01	TAMPO CO-1455 /445	1455 x 445	25	BASE	10350
		07	03	FUNDO (F3) CO-1410 /323	1410 x 323	03	BASE	10351
		08	02	PERFIL H (F3) CO-1385 /35	1385 x 35	12	BASE	10352
		09	02	COLUNA LATERAL CO-1015 /35	1015 x 35	25	BASE	10341
<b>ANTES DE FIXAR A CANTONEIRA, VERIFICAR QUAL SERÁ O LADO EXTERNO DO FRONTÃO</b> <b>LADO FRISADO</b> OU <b>LADO FRISO /MOLD</b>		10	01	FRONTÃO CO-1397 /90	1397 x 90	15	BASE	10353
		11	01	PORTA RETA CO-875 /335	875 x 335	15	GAVETA	10766
		12	01	PORTA PUXADOR CO-875 /335	875 x 335	15	GAVETA	10767

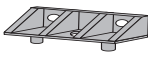
FIXAR AS FERRAGENS	DESENHO DAS PEÇAS	ORD.	QTD.	NOME DA PEÇA	MEDIDA (mm)	MDF (mm)	ESTÁ NO VOLUME	CÓDIGO
		13	01	BATENTE PORTA CO-875 /55	875 x 55	15	GAVETA	10768
		14	02	PRATELEIRA CO-685 /395	685 x 395	15	GAVETA	10765
		15	08	LATERAL GAVETA (F6) CO-395 /160	395 x 160	15	GAVETA	06381
		16	04	FRENTE GAVETA (F6) CO-690 /200	690 x 200	15	GAVETA	10763
		17	04	TRASEIRO GAVETA CO-630 /130	630 x 130	15	GAVETA	10355
		18	04	FUNDO GAVETA (F6) CO-645 /402	645 x 402	06	GAVETA	10764

ORD.	DESENHO DA FERRAGEM	BASE	NOME DA FERRAGEM	PARA FIXAR	CÓDIGO
A		10	SAPATA COM PINO	Base e laterais ou nos pés	00645
B		4P	CORREDIÇA TELESCÓPICA 400 mm	Gavetas	00006
C		124	PARAF. 3,5 x 14 (CAB. CHATA)	Corrediças, cantoneiras plásticas, calços, dobradiças, uniões e suportes triangulares	07857
D		04	BUCHA CILÍNDRICA 12 x 12	Laterais na base	07927
E		04	PARAF. 5 x 50 (CAB. FLANG.)	Laterais na base	07856
F		40	CAVILHA 6 x 30	Base, divisão, batentes de gavetas, tampo nas laterais e gavetas	01910
G	TAMBOR  PINO 	08	CONJUNTO MINIFIX	Divisão e tampo nas laterais	01911
H		50	PARAF. 3,5 x 16 (CAB. FLANG.)	Fundos da cômoda e de gavetas	07858
I		22	PARAF. 4 x 30 (CAB. CHATA)	Colunas laterais e traseiros de gavetas	07860
J		10	CANTONEIRA PLÁSTICA	Batentes de gavetas centrais e frontão	10474
K		08	SUPORTE PRATELEIRA	Prateleiras	06824
L		04	CALÇO "A" 3mm	Portas	02421
M		04	DOBRADIÇA 35mm	Portas	01592
N		04	PARAF. 4 x 25 (CAB. FLANG.)	Batente na porta	07875
O		16	UNIÃO	Gavetas	03205
P		08	SUP. TRIANGULAR	Fundos de gavetas	02423

# AS VEZES OS FUROS DAS CORREDIÇAS NÃO BATEM COM AS MARCAÇÕES

Fixar as corrediças alinhadas com os furos de marcações e com a borda da frente da lateral esquerda e divisão

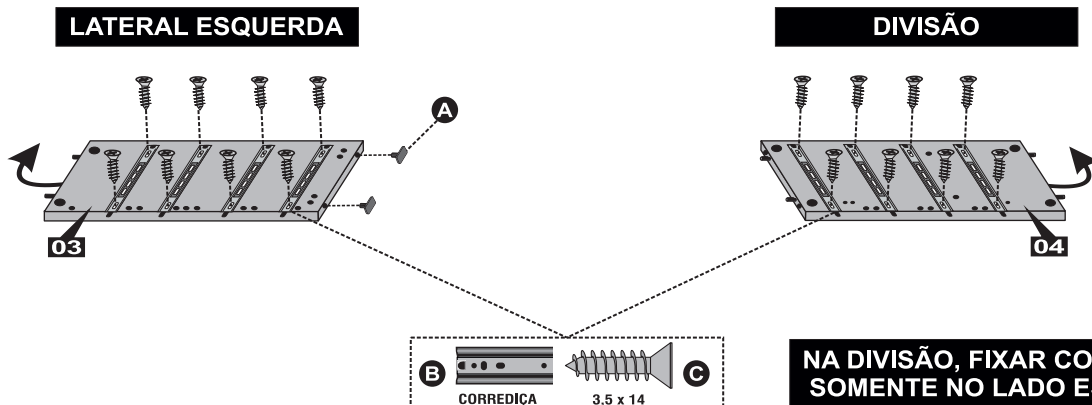

**01** Fixar as laterais na base.

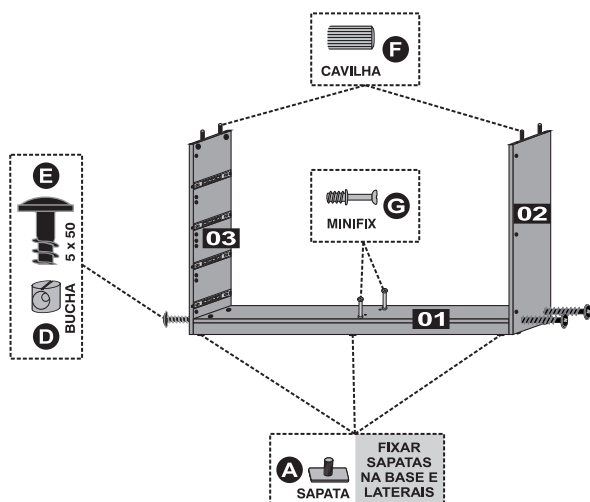

**02** Fixar a divisão, encaixar os batentes nela e na lateral esquerda, em seguida fixar o tampo.

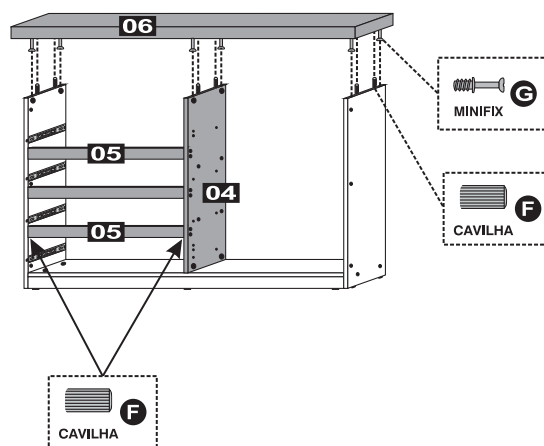

**03** Fixar os fundos unindo-os com o perfil H.

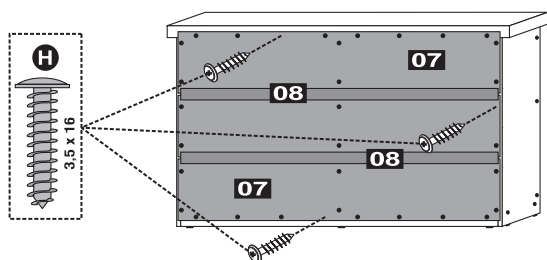

**04** Fixar o batente central na lateral esquerda e na divisão usando cantoneiras plásticas.

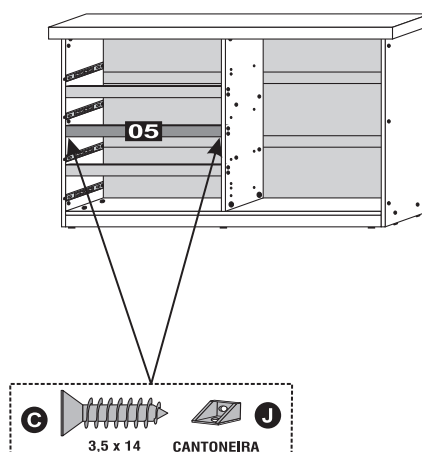

**05** Fixar as colunas laterais.

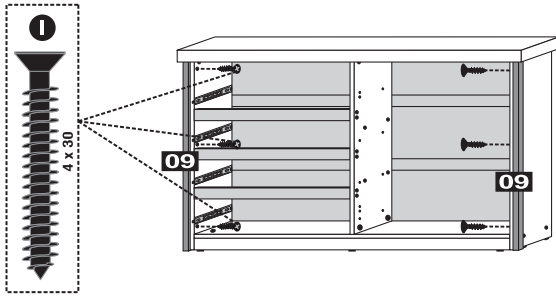

**06** Antes de fixar as cantoneiras, verificar qual será o lado externo do frontão.

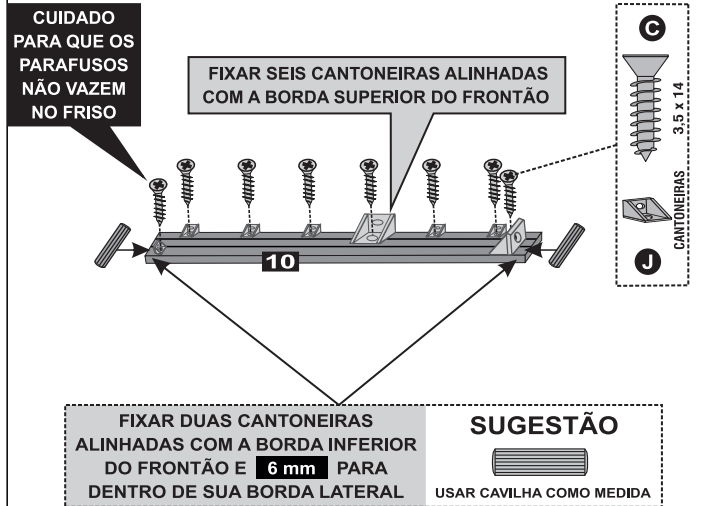

**07** Fixar o frontão encostado nas laterais, divisão e tampo.

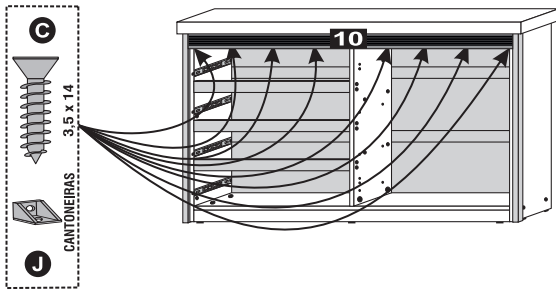

**08** Fixar os suportes prateleiras e os calços na divisão e lateral direita.

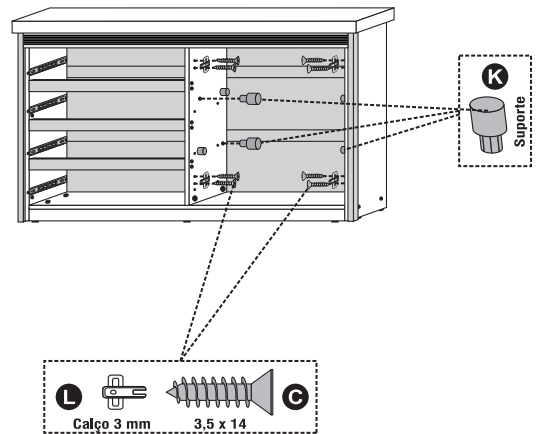

**09** Fixar as dobradiças bem alinhadas nas portas.

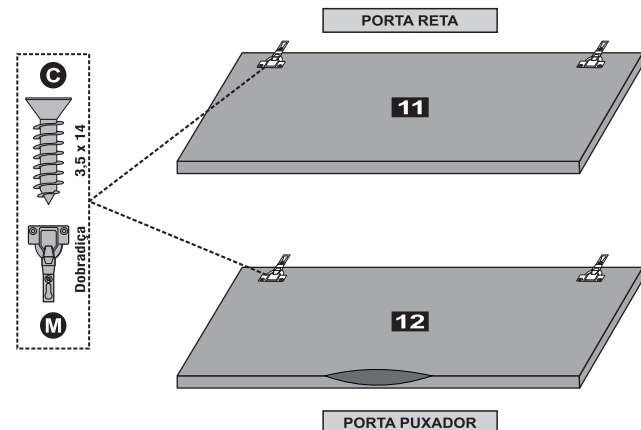

**10** Encaixar o batente e fixá-lo centralizado na porta reta.

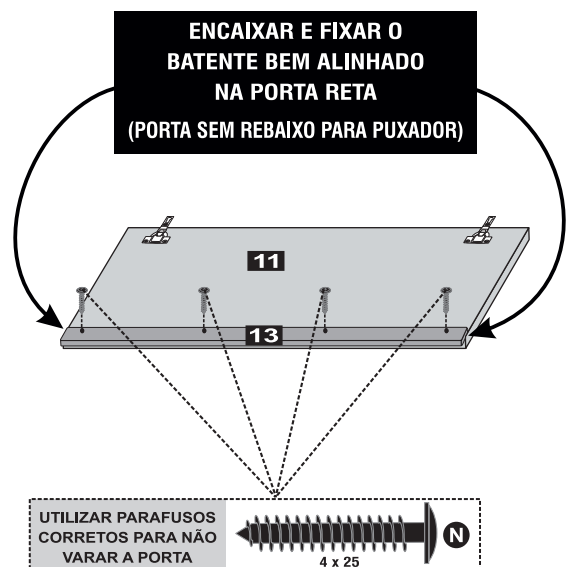

**11** Colocar as prateleiras e fixar as portas nos calços.

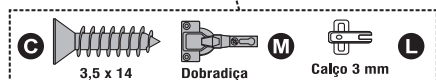
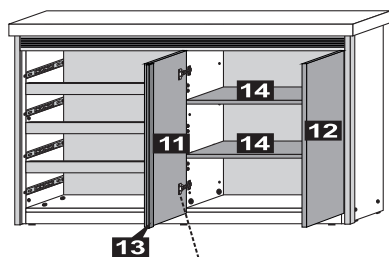

**12** Fixar as uniões e cavilhas nas laterais **fazendo par.**

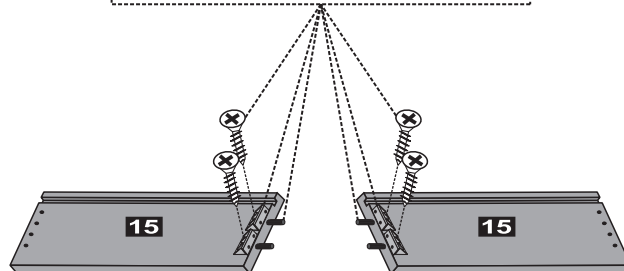

**LADO ESQUERDO**

**LADO DIREITO**

**13** Montar as gavetas.

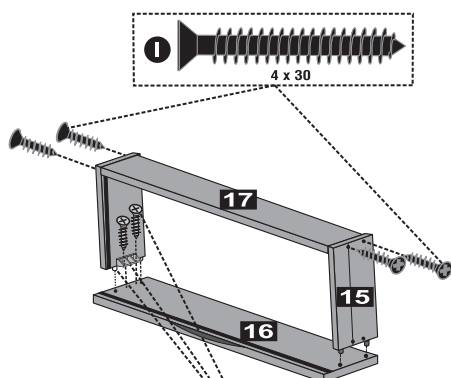

**14** Fixar os fundos e suportes triangulares nas gavetas.

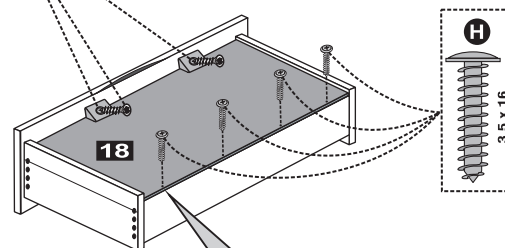
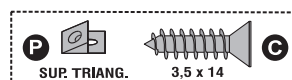

AJUSTAR BEM OS FUNDOS COLOCANDO A GAVETA NO ESQUADRO E FIXAR OS PARAFUSOS  $\pm 60$  mm AFASTADOS DAS BORDAS DO TRASEIRO PARA NÃO RACHAR.

**15** Fixar as corredeças nas linhas de marcações das laterais encostadas na frente de gaveta.

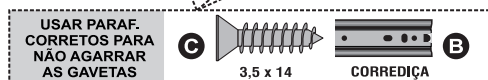
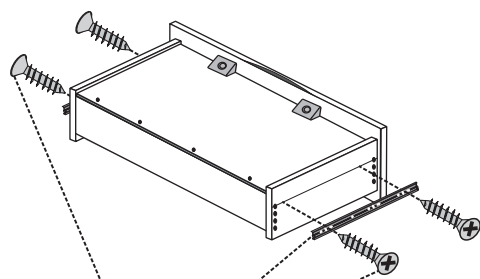

**16** Colocar as gavetas na cômoda.

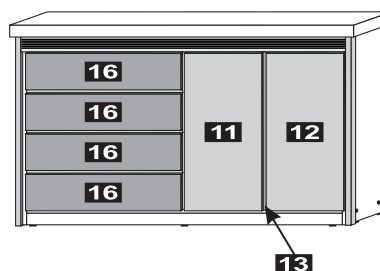

**Solicitar Assist. Técnica pelo nome e código das peças e das ferragens, informando cor e número do lote.**

Montador, obrigado pelo cuidado com nossos produtos. Deixe este manual com o consumidor.  
Quaisquer dúvidas na montagem, falar com nosso controle de qualidade (32) 3539-7700 - tecnica@moveisbettio.com.br