

# MANUAL DE MONTAGEM

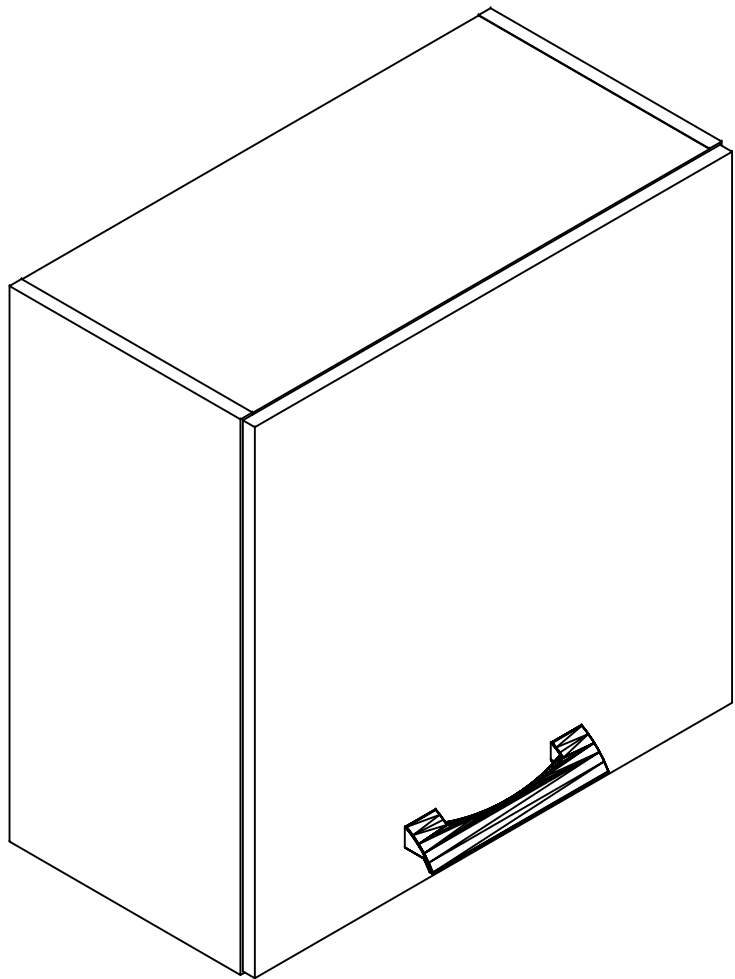





**Parabéns, você acaba de adquirir um produto Kappesberg!**



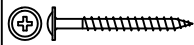
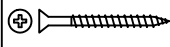



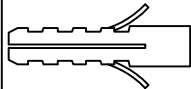

A Kappesberg é uma marca que cresceu e se desenvolveu com a população brasileira e de todos os países para onde exporta, e ao longo destes anos participa do seu dia-a-dia. É por isso que o design hoje é parte da sua vida, a qualidade de cada móvel é um compromisso diário e a inovação vem para oferecer ao cliente a confiança nessa grande parceria.

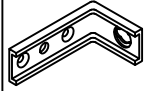

**Garantia de 03 (três) meses,  
por defeito de fabricação.**

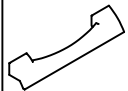
Lista de peças						
Código de assistência	Descrição	Quant.	Compr. (mm)	Larg. (mm)	Espes. (mm)	Caixa/ volume
01	Lateral direita	1	600	288	15	A
02	Lateral esquerda	1	600	288	15	A
03	Porta	1	595	595	15	A
04	Base	1	570	288	15	A
05	Chapéu	1	570	288	15	A
06	Prateleira	1	570	256	15	A
07	Costa	1	590	590	3	A

Ferragem			
	Código de assistência	Descrição	Quant.
A	95	 Parafuso flange 5,0x50 zincado branco	2
B	226	 Parafuso chato 4,0x40 bicromatizado	8
C	14773	 Parafuso flange 3,5x25 zincado branco	2
D	491	 Parafuso chato 4,0x25 bicromatizado	3
E	4214	 Parafuso chato 3,5x14 cabeça rebaixada	4
F	107	 Prego 10 x 10	25
G	1802	 Cavilha 6x30mm	12
H	40534	 Batente de silicone com logo "K"	2
I	529	 Buchas invasa	2

J	17024	 Suporte aéreo metalizado zincado branco	2
K	6959	 Capa para suporte aéreo metal branca	2
L	7787	 Dobradiça reta 35	2
M	7787	 Calço para dobradiça	2
N	7787	 Parafuso panela 4,0x14 para dobradiça	8
O	31875	 Puxador 411 (pz03) onix 160mm	1
P	31998	 Tapa furo adesivo Nature	8
Q	58	 Etiqueta marca "Kappesberg"	1
R	41	 Cola branca em bisnaga (10g)	1



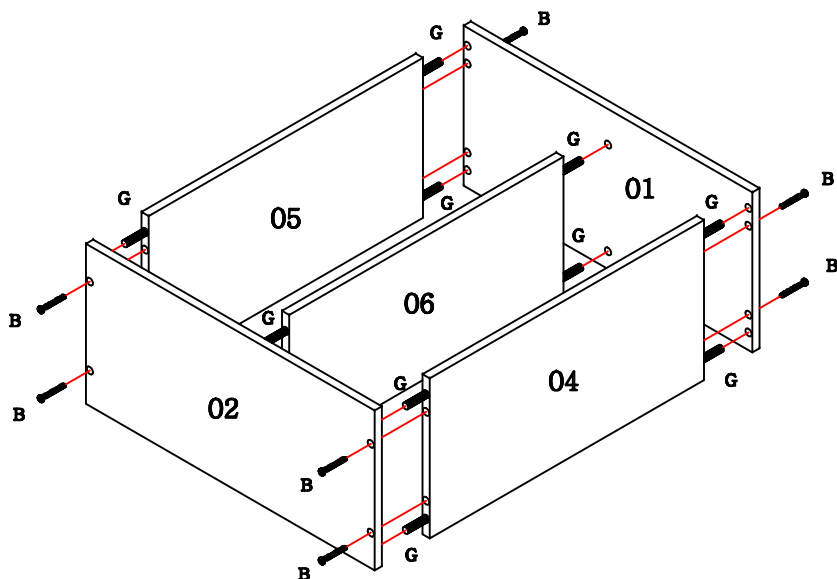

As batentes de silicone "H" são colocadas na porta, para suavizar eventuais impactos.

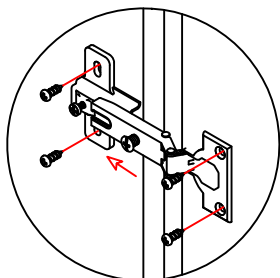

A dobradiça "L" deve ser encaixada no calço "M" e estes colocados com os parafusos "N", observando o procedimento a cima.

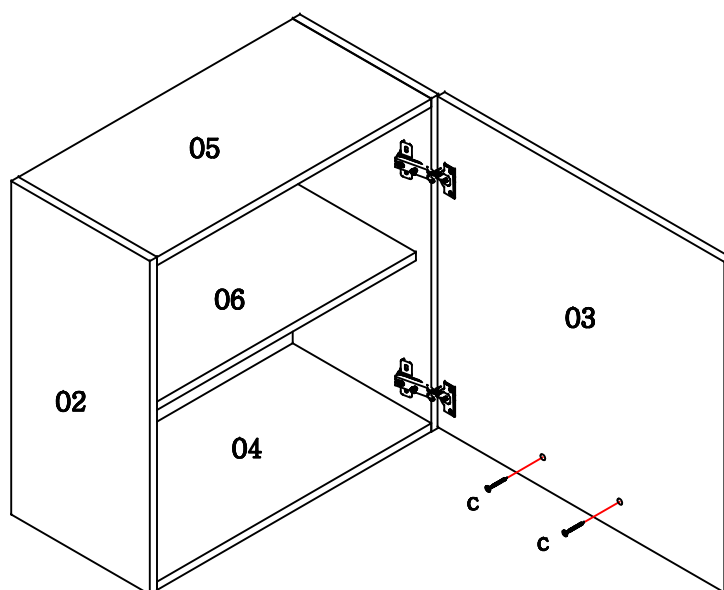

Ao fixar a costa, recomenda-se um espaçamento de aproximadamente 10 cm entre os pregos.

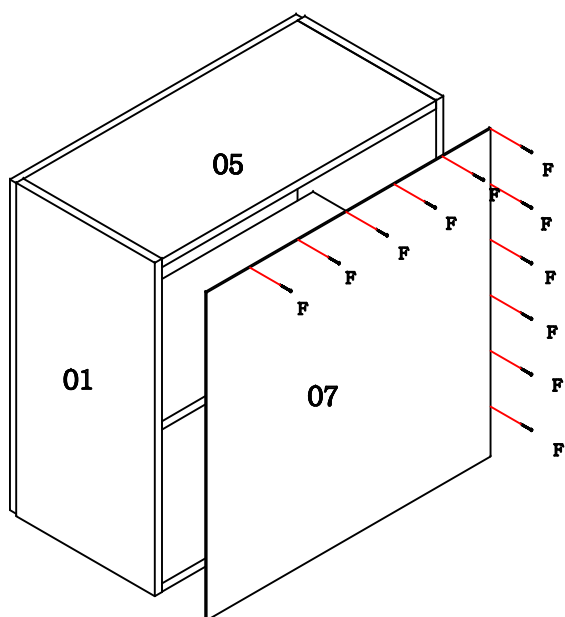

Utilize o parafuso "D" para fixar um módulo em outro.

Para fixar o aéreo na parede:

- Em cada lateral fixe um suporte aéreo metalizado "J" com o parafuso "E" e na parede com o parafuso "A" e com a bucha "I".
- Coloque uma capa "K" em cada suporte "J".