

MANUAL DE MONTAGEM

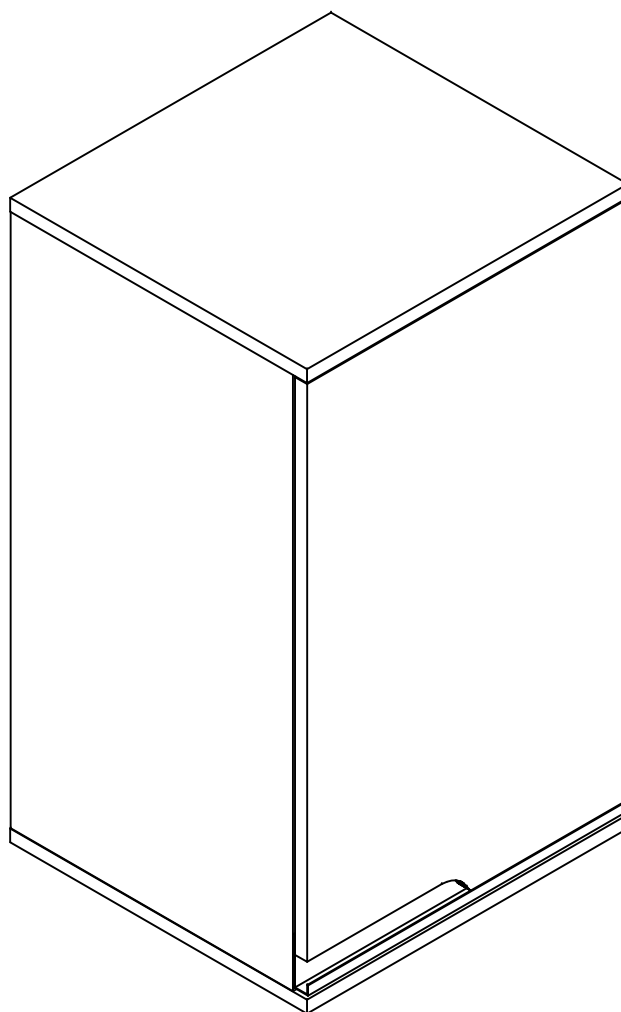







Parabéns, você acaba de adquirir um produto Kappesberg!

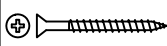





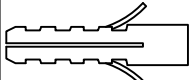



A Kappesberg é uma marca que cresceu e se desenvolveu com a população brasileira e de todos os países para onde exporta, e ao longo destes anos participa do seu dia-a-dia. É por isso que o design hoje é parte da sua vida, a qualidade de cada móvel é um compromisso diário e a inovação vem para oferecer ao cliente a confiança nessa grande parceria.



**Garantia de 03 (três) meses,
por defeito de fabricação.**

Lista de peças						
Código de assistência	Descrição	Quant.	Compr. (mm)	Larg. (mm)	Espes. (mm)	Caixa/ volume
01	Lateral direita	1	666	352	15	A
02	Lateral esquerda	1	666	352	15	A
03	Prateleira	1	369	288	15	A
04	Base	1	400	370	15	A
05	Chapéu	1	400	370	15	A
06	Porta	1	659	396	15	A
07	Costa	1	686	390	3	A

Ferragem			
	Código de assistência	Descrição	Quant.
A	95	 Parafuso flange 5,0x50 zincado branco	2
B	226	 Parafuso chato 4,0x40 bicromatizado	12
C	25827	 Parafuso flange 3,5x14 zincado branco	2
D	491	 Parafuso chato 4,0x25 bicromatizado	3
E	4214	 Parafuso chato 3,5x14 cabeça rebaixada	4
F	107	 Prego 10 x 10	30
G	1802	 Cavilha 6x30mm	12
H	40534	 Batente de silicone com logo "K"	2
I	529	 Bucha invasa	2
J	17024	 Suporte aéreo metalizado zincado branco	2

K	6959	 Capa para suporte aéreo metal branco	2
L	7787	 Dobradiça reta 35	2
M	7787	 Calço para dobradiça	2
N	7787	 Parafuso panela 4,0x14 para dobradiça	8
O	31275	 Puxador solaris 396mm Carvalle	1
O	31274	 Puxador solaris 396mm Branco	1
O	31599	 Puxador solaris 396mm Aspen	1
P	14720	 Tapa furo adesivo Carvalle	12
Q	58	 Etiqueta marca "Kappesberg"	1
R	41	 Cola branca em bisnaga (10g)	1



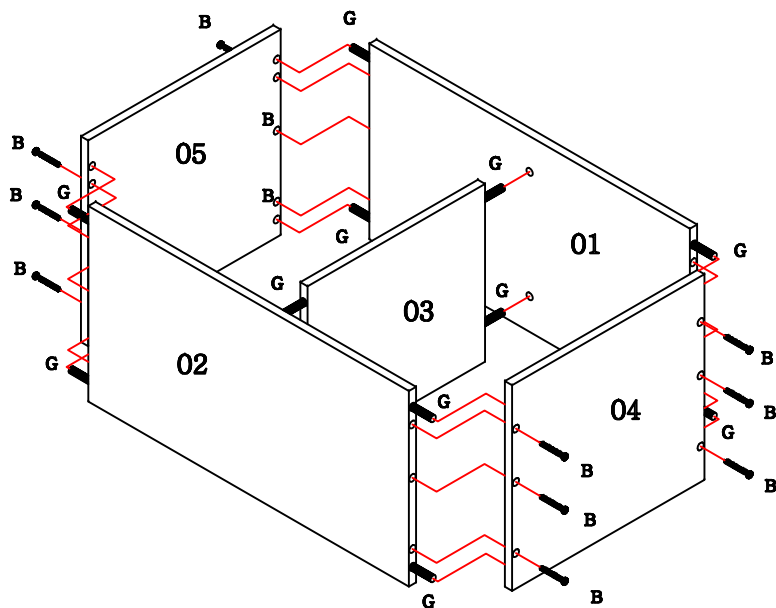

Utilize o parafuso "D" para fixar um módulo em outro.

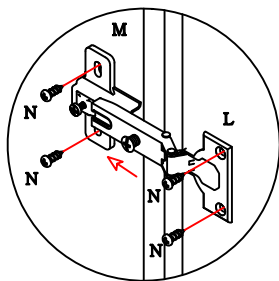

A dobradiça "L" deve ser encaixada no calço "M" e estes colocados com os parafusos "N", observando o procedimento a cima.

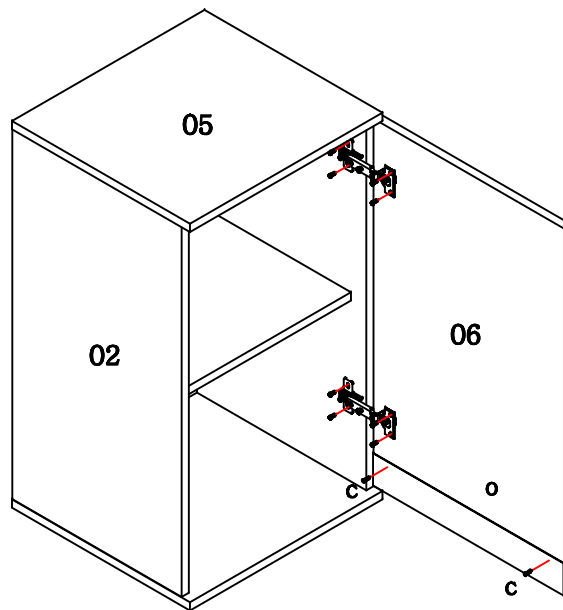

As batentes de silicone "H" são colocadas na porta, para suavizar eventuais impactos.

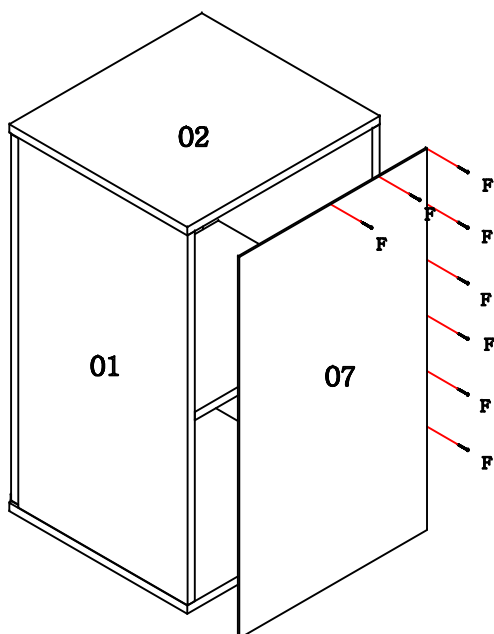

Ao fixar a costa, recomenda-se um espaçamento de aproximadamente 10 cm entre os pregos.

- Para fixar o módulo na parede:
- Nas laterais fixe um suporte aéreo metalizado "J" com o parafuso "E" e na parede com o parafuso "A" e com a bucha "I".
 - Coloque uma capa "K" nos suportes "J".