











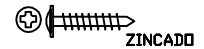















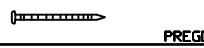
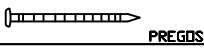









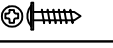
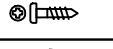



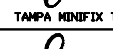
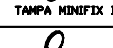

Rua da Emancipação, 2000 - Tupandi - RS

Fone: (51) 3635-8800
www.kappesberg.com.br

REF.: S742

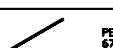
"OBS: Para solicitar assistência técnica, utilize o código da ferragem indicada."

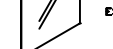
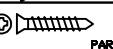
	CÓD.	FERRAGEM	QTDE
A	4042	 ZINCADO PRETO 4,0x40	35
A	4404	 PINTADO BRANCO 4,0x40	35
A	2592	 ZINCADO BRANCO 4,0x40	35
B	14773	 ZINCADO 3,5x25	04
C	4214	 3,5x14	63
D	1446	 SUPORTE ROLÇO PARA CABIDEIRO DE PLÁSTICO	04
E	118	 SUPORTE PRATELEIRA	04
F	226	 CHATO 4,0x40	03
G	9351	 PUXADOR ARUBA PRETO	01
G	9408	 PUXADOR ARUBA BRANCO	01
G	25677	 PUXADOR ARUBA MOKA	01
H	9330	 PUXADOR DE METAL PRETO BRILHANTE	01
H	9409	 PUXADOR DE METAL BRANCO BRILHANTE	01
H	19695	 PUXADOR DE METAL MOKA BRILHANTE	01
I	30142	 PUXADOR 32mm CROMADO	02
J	1802	 CAVILHA 6x30	43
K	1925	 CAVILHA 6x50	03
L	1901	 SAPATA DESLIZADORA PRETA	08
M	899	 CANTONEIRA METAL	03
N	41	 COLA BRANCA	01
□	107	 PREGOS 10x10	101
P	149	 PREGOS 13x15	09
Q	1423	 FIXADOR DE COSTA	25

R	85	 'L' DE METAL	06
S	58	 kappesberg	01
T	5288	 CORREDORA METÁLICA 400MM	02
U	35935	 ROLÇO OBLONGO FRISADO 680mm	02
V	2170	 TAMBOR MINIFIX	02
X	2170	 PARAFUSO MINIFIX	02
Z	1178	 FLANGEADO CHATO 3,5x15	02
W	1828	 PARAFUSO PANELA 3,5x14	08
Y	4860	 ROLETE SEM REGULAGEM	02
AA	4860	 ROLETE COM REGULAGEM	02
AB	4860	 GUIA METÁLICO	04
AC	8090	 TAMPA MINIFIX TEÇA ITALIA	02
AC	2347	 TAMPA MINIFIX BRANCA	02
AC	14855	 TAMPA MINIFIX CARVALLE	02
AD	9322	 PERFIL DE ALUMÍNIO 140,6cm	02
AE	9325	 PERFIL DE PLÁSTICO 140,6cm	02
AF	9407	 BARRA DE METAL BRANCA 2117mm	04
AF	9327	 BARRA DE METAL PRETA 2117mm	04
AF	19841	 BARRA DE METAL MOKA 2117mm	04
AF	16078	 BARRA DE METAL CARVALLE 2117mm	04
AG	40534	 GOTAS DE SILICONE PARA AS PORTAS	02
AH	9338	 PERFIL T 677mm	02
AI	9337	 ESPELHO 693 x 669 mm	03
AJ	5256	 PARAFUSO CHATO 4,0x20	04
AK	18458	 SUPORTE TRIANGULAR PRETO	04

REF.: S742

Rua da Emancipação, 2000 - Tupandi - RS

Fone: (51) 3635-8800

www.kappesberg.com.br

RELAÇÃO DE PEÇAS

- 17331-LATERAL ESQUERDA
- 17332-LATERAL DIREITA
- 17333-DIVISÓRIA
- 17334-CHAPÉU
- 17335-BASE
- 17336-BASE DO MALEIRO
- 17337-PRATELEIRA
- 17338-PRATELEIRA DO CALCEIRO
- 17339-RODAPÉ DIANTEIRO
- 17340-RODAPÉ TRASEIRO
- 17341-RODAPÉ INTERNO
- 17342-RODAFORRO
- 17343-TAMPO DE GAVETA
- 17344-PILASTRAS
- 17345-FRENTE DE GAVETA
- 17346-LATERAL DE GAVETA
- 17347-CABECEIRA DE GAVETA
- 17348-FUNDO DE GAVETA
- 17349-COSTA
- 17350-COSTA DO MALEIRO
- 17351-PORTAS DO ESPELHOS
- 17352-PORTAS COM FRISOS

GARANTIA POR DEFEITOS DE
FABRICAÇÃO DE 03 MESES.

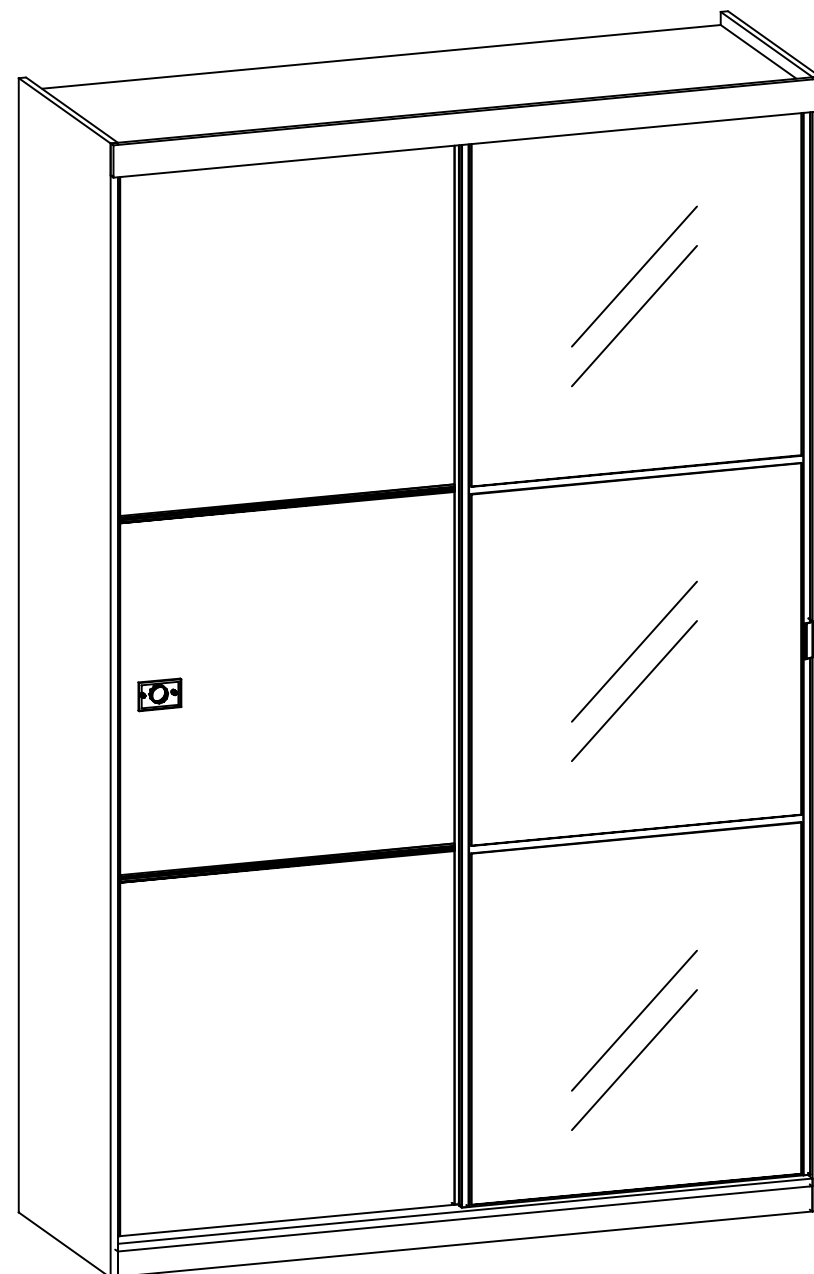

↑
"OBS: Para
solicitar
assistência técnica,
utilize o código das
peças indicada."

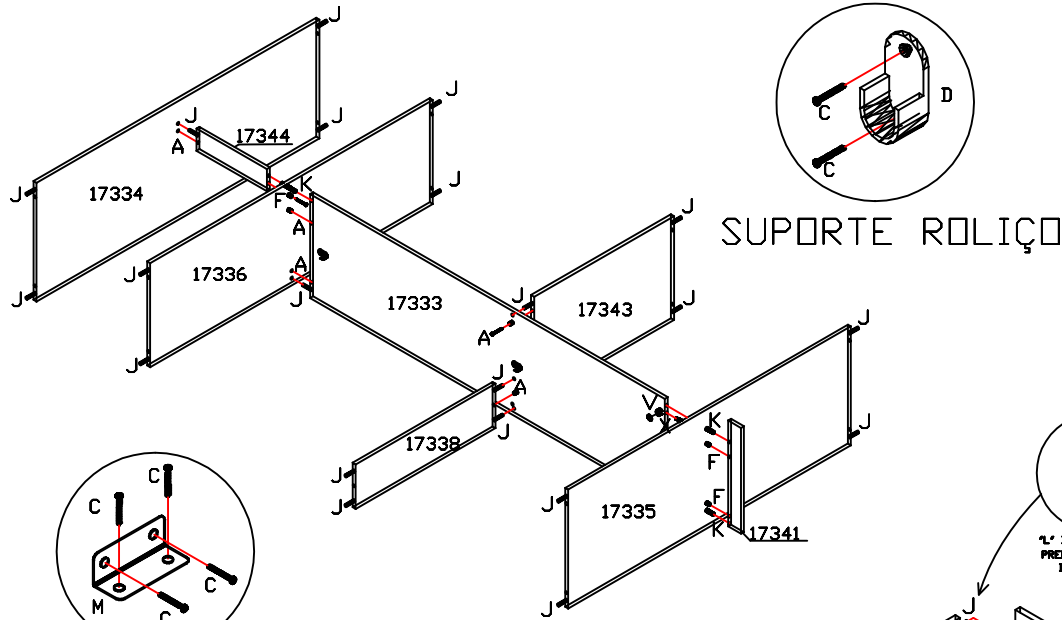

SUPORE ROLIÇO

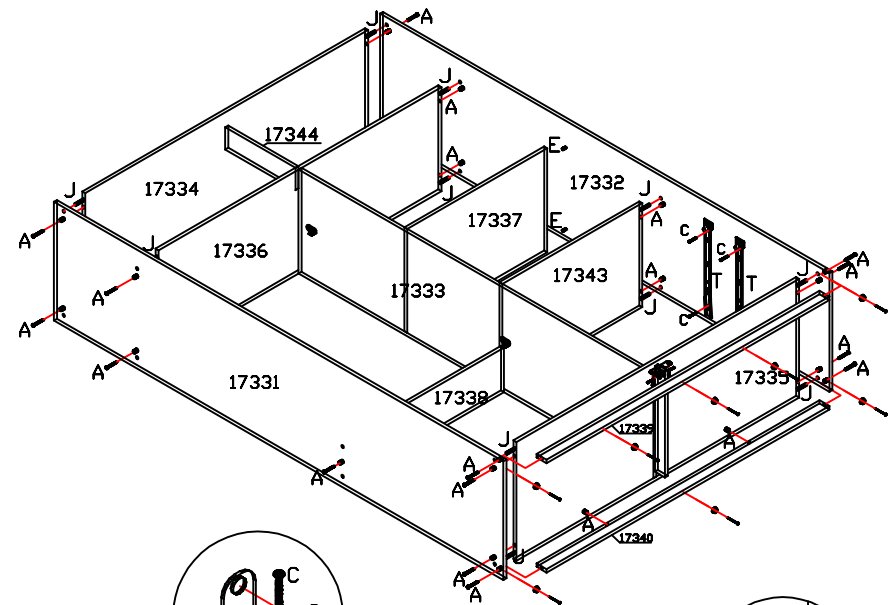

"L" DE METAL PARA PRENDER A FRENTE DE GAVETA

CANTONEIRA DE METAL PARA FIXAR O RODAFORRO

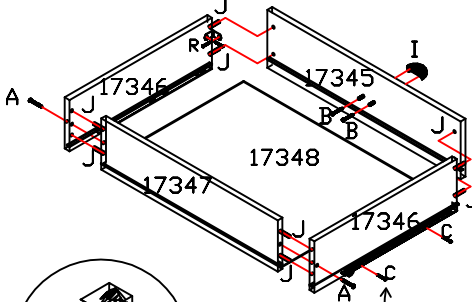
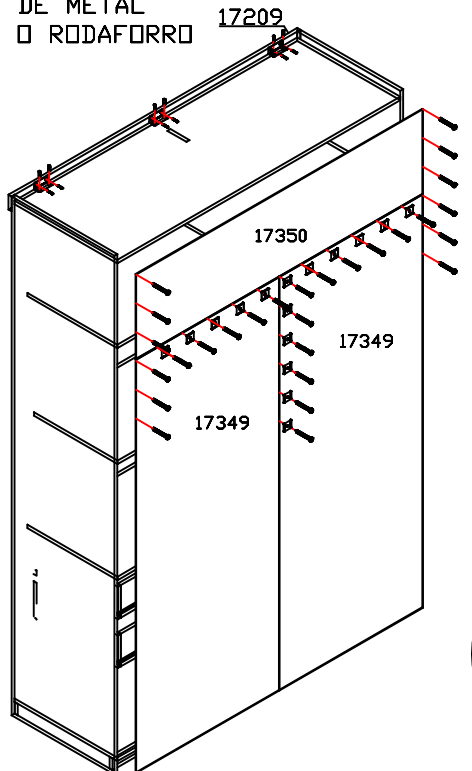

"L" DE METAL PARA PRENDER A FRENTE DE GAVETA

"Dica: Colocar os parafusos da corredeira pelo lado e não por baixo."

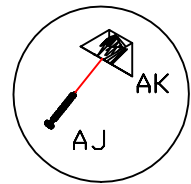

DETALHE DO SUPORTE DE GAVETA ESTE DEVE SER FIXADO ABAIXO DO FUNDO DE GAVETA DOIS NA FRENTE E DOIS ATRAS APÓS A GAVETA ESTAR MONTADA



"L" DE METAL PARA PRENDER O RODAPÉ FRONTAL

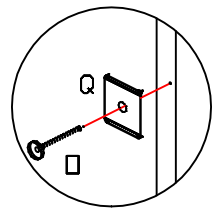
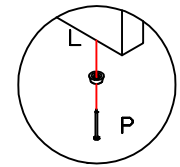

□ puxador da porta sem espelhos "G" é fixado com o parafuso "Z"

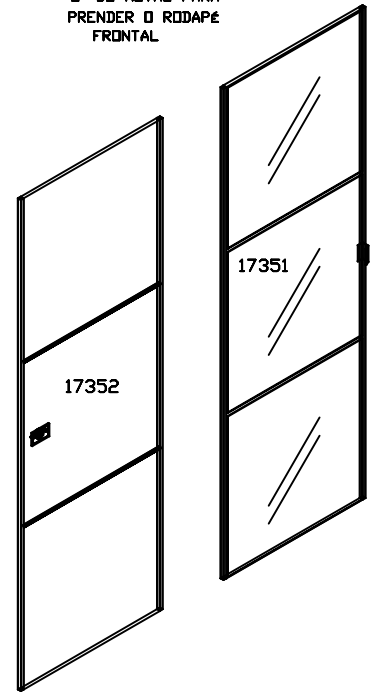

□ puxador da porta com espelhos "H" é fixado com o parafuso "C"

IMPORTANTE

S742

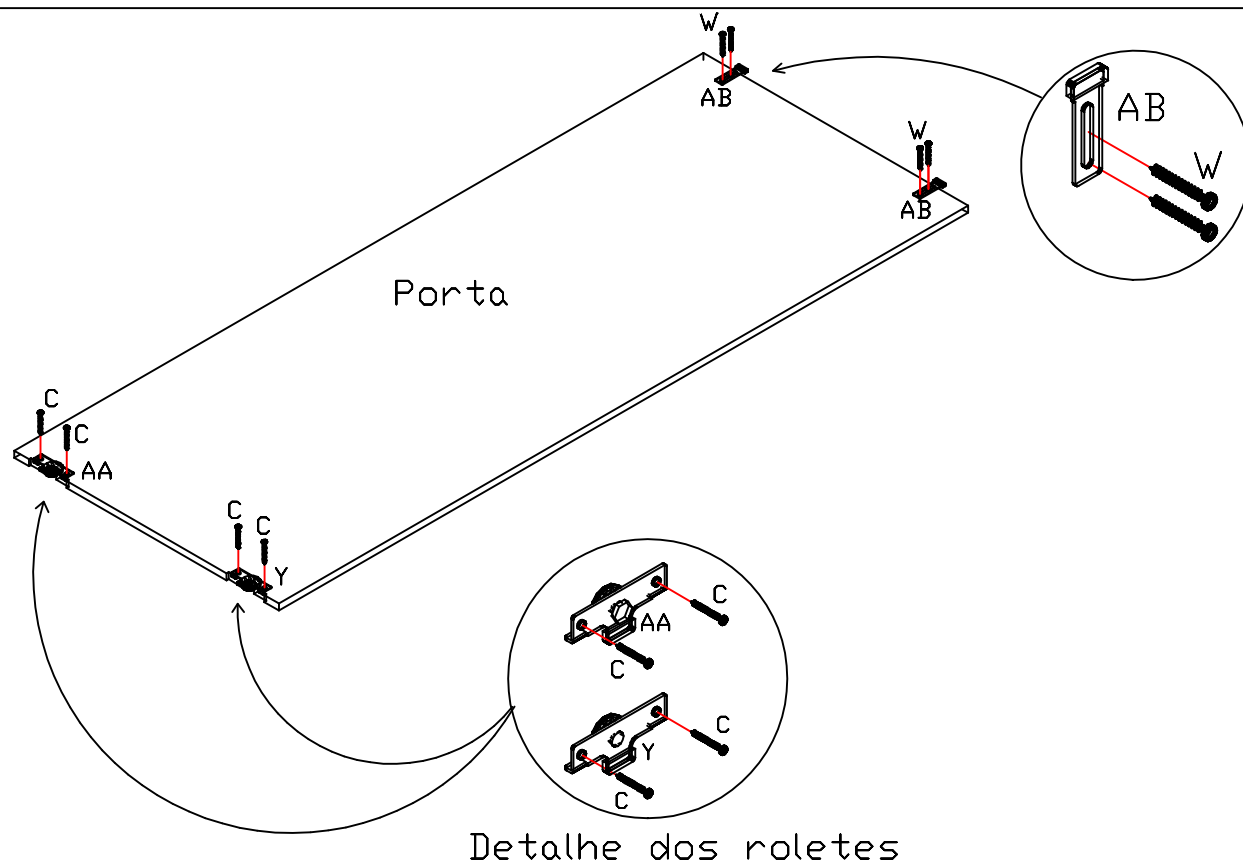

Detalhe dos roletes

Para melhor montar as portas coloque o rolete com regulagem "AA" no lado do puxador e o rolete sem regulagem "Y" no lado oposto do puxador. Os guias "AB" devem ser fixados com um parafuso "W", mais não deve ser apertado antes de encaixar a porta no trilho de alumínio. Após encaixar a porta no móvel levante o guia "AB" p/ dentro do trilho, mais não o precione demais contra o trilho (deixar uma folga entre o guia e o trilho, para que a porta deslize melhor) que está no chapéu e aperte bem o parafuso. Em seguida coloque o segundo parafuso em cada guia.

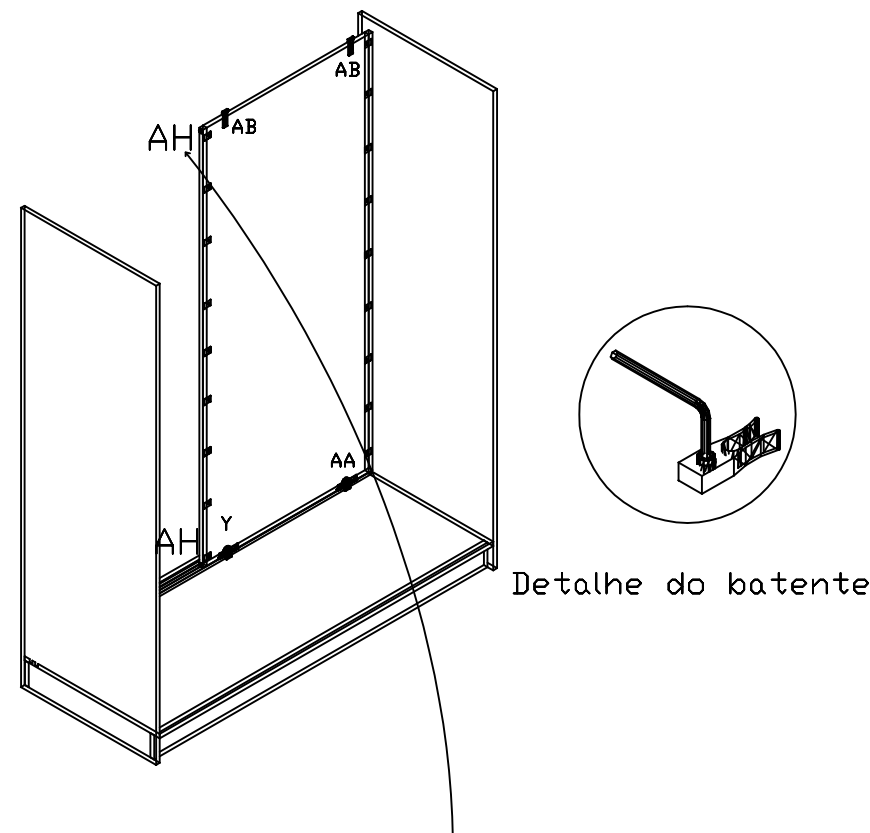

Detalhe do batente

Obs: No acessório contem 2 Gotas de Silicone "AH" que devem ser colodas nas portas, para que as mesmas não batam com tanta força nas laterais e uma na outra.

- ① As portas não devem bater nas laterais do roupeiro. Devem parar 2mm antes. Para isso regule o batente plástico que está colocado dentro dos trilhos de alumínio do chapéu.
- ② A porta não pode bater no puxador da outra porta. Ajuste o batente.