



JCM
movelaria

CÔMODA LÍDIA LÍDIA CHEST OF DRAWERS CÓMODA LÍDIA



ENCONTRE UM MONTADOR
FAÇA SEU ORÇAMENTO ▶ BAIXE O APP

Cupom: JCM30



Indicamos que a montagem dos produtos seja realizada com parafusadeira eléctrica e por um montador profissional.
We recommend that a professional furniture assembler assemble the product by using a cordless screwdriver.
Se recomienda que un montador de muebles profesional realice el montaje del producto con un destornillador eléctrico.

AVISO: Não nos comprometemos pelo mal-uso, montagem e fixação do produto à parede. Portanto, não somos responsáveis por danos e quedas do produto, eletrônicos e pertences neles contidos. É importante o uso de brocas e ferramentas compatíveis na montagem.
NOTICE: The company is not responsible for the misuse, assembly, and wall fixation, as well as the damages and falls that the products, electronics, and belongings therein might suffer. It is important to use suitable drills and tools to assemble the product.
ATENCIÓN: La empresa no se responsabiliza del mal uso, montaje y fijación del producto a la pared, así como de daños y caídas del producto, electrónicos u objetos. Es importante el uso de taladros y herramientas compatibles con el montaje.

Dica: para evitar possíveis avarias, use a embalagem do produto como apoio durante a montagem.
Tip: to avoid damages, use the product packaging as a base during the assembly.
Pista: para evitar daños, use el envase del producto como apoyo durante el montaje.

RELAÇÃO DE FERRAGENS | HARDWARE LIST | LISTADO DE HERRAJES

CAVILHA 6x30	(A)	6x30 DOWEL	(A)	CLAVIJA 6x30	(A)		24
CONECTOR 2 FUROS	(B)	2-HOLE CORNER BRACKET	(B)	SOPORTE ANGULAR 2 AGUJEROS	(B)		08
PARAFUSO 3,5x14	(C)	3.5x14 SCREW	(C)	TORNILLO 3,5x14	(C)		32
PARAFUSO 4x25	(D)	4x25 SCREW	(D)	TORNILLO 4x25	(D)		08
PARAFUSO 3,5x14 FLANG.	(E)	3.5x14 FLANGE SCREW	(E)	TORNILLO TIPO FLANGE 3,5x14	(E)		28
PARAFUSO 5x40	(F)	5x40 SCREW	(F)	TORNILLO 5x40	(F)		16
PARAFUSO MINIFIX	(G)	MINIFIX BOLT	(G)	PERNO MINIFIX	(G)		04
PREGO 8x8 C/C	(H)	8x8 NAIL	(H)	CLAVO 8x8	(H)		55
TAMBOR MINIFIX	(I)	MINIFIX CAM LOCK	(I)	CAJA DEL MINIFIX	(I)		04

RELAÇÃO DE PEÇAS | PARTS LIST | LISTADO DE PARTES

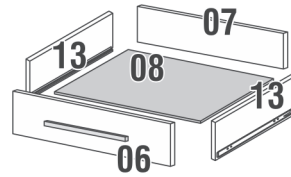
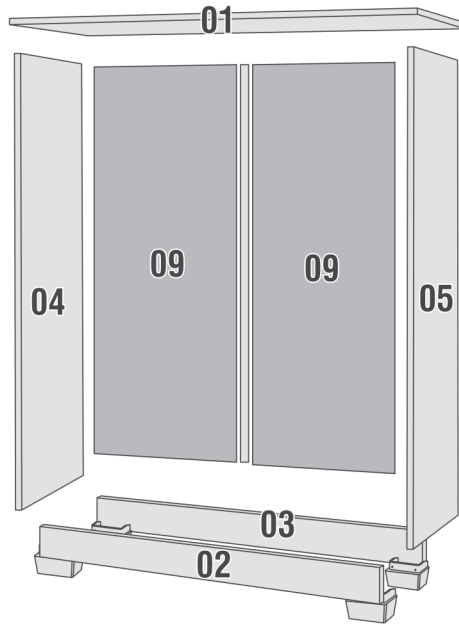

01 TAMPO
TOP
TAPA 1PC
1PC
1PZA



06 FRETE GAVETA
DRAWER FRONT
FRENTE DEL CAJÓN 4PCS
4PCS
4PZAS



02 RÉGUA PÉ FRONTAL
FRONT TOE
ZÓCALO FRONTAL 1PC
1PC
1PZA



07 TRASEIRO GAVETA
DRAWER BACK
TRASERA DEL CAJÓN 4PCS
4PCS
4PZAS



03 RÉGUA PÉ TRASEIRO
BACK TOE
ZÓCALO TRASERO 1PC
1PC
1PZA



08 FUNDO GAVETA
DRAWER BOTTOM
FONDO DEL CAJÓN 4PCS
4PCS
4PZAS



04 LATERAL ESQUERDA
LEFT SIDE
LATERAL IZQUIERDO 1PC
1PC
1PZA



13 LATERAL GAVETA
DRAWER SIDE
LATERAL DEL CAJÓN 8PCS
8PCS
8PZAS



05 LATERAL DIREITA
RIGHT SIDE
LATERAL DERECHO 1PC
1PC
1PZA

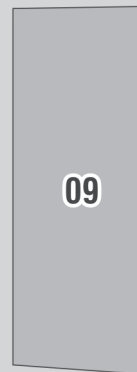

09 COSTAS GAVETAS
BACK PANELS
PANELES TRASEROS 2PCS
2PCS
2PZAS



06 PÉ
FEET
PATAS 4PCS
4PCS
4PZAS

IMPORTANTE | NOTE | ¡ATENCIÓN!
FAÇA A MONTAGEM COM A CÔMODA DEITADA COM AS COSTAS PARA O CHÃO.
ASSEMBLE THE DRESSER WITH ITS BACK FACING THE FLOOR.
MONTE LA CÔMODA CON SU TRASERA TUMBADA EN EL SUELO.

- Passo 01** ENCAIXE AS PEÇAS 4 E 5 NA PEÇA 1 COM MINIFIX (G+I), JÁ COLOCANDO AS CORREDIÇAS COM PARAFUSO 3,5x14 (C).
Step 01 ATTACH PARTS 4 AND 5 TO PART 1 WITH MINIFIX (G+I), AND ALSO FASTEN THE SLIDES WITH 3.5x14 SCREWS (C).
Paso 01 ENCAJE LAS PARTES 4 Y 5 EN LA PARTE 1 CON MINIFIX (G+I), Y FIJE LAS CORREDERAS CON TORNILLOS 3,5x14 @.

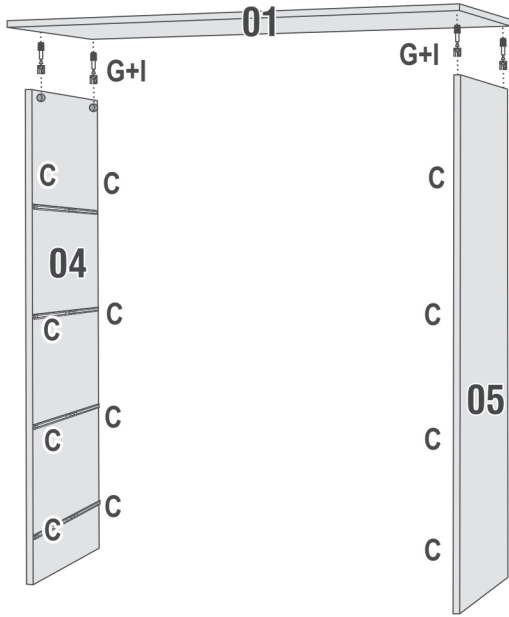

C = 16 G = 4 I = 4

- Passo 02** PARAFUSE AS PEÇAS 2 E 3 NAS PEÇAS 4 E 5 COM PARAFUSO 5x40 (F).
Step 02 ATTACH PARTS 2 AND 3 TO PARTS 4 AND 5 WITH 5x40 SCREWS (F).
Paso 02 FIJE LAS PARTES 2 Y 3 A LAS PARTES 4 Y 5 CON TORNILLOS 5x40 (F).

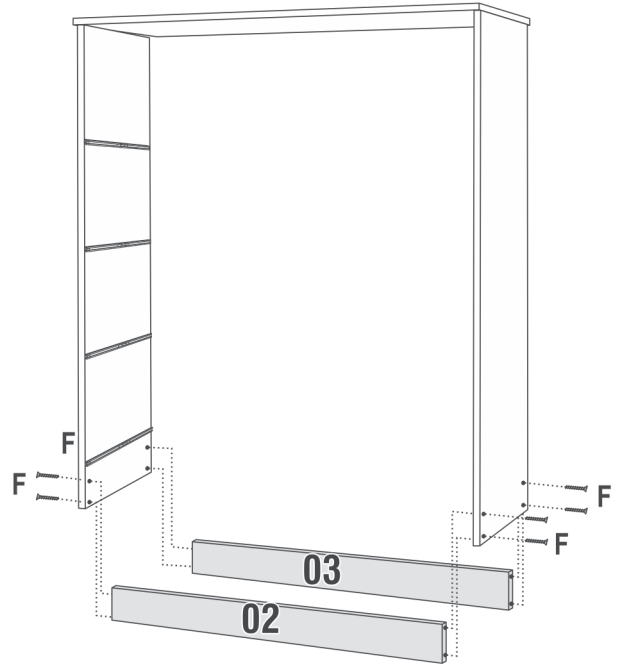

F = 8

- Passo 03** PARAFUSE OS PÉS COM PARAFUSO 3,5x14 FLANGEADO (E).
Step 03 FASTEN THE FEET WITH 3.5x14 FLANGE SCREWS (E).
Paso 03 ATORNILLE LAS PATAS CON TORNILLOS TIPO FLANGE 3,5x14 (E).

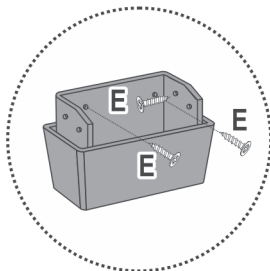
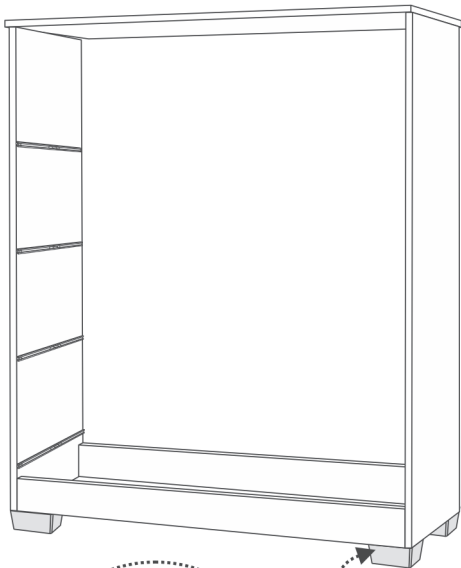

E = 12

- Passo 04** PREGUE AS COSTAS COM PREGO 8x8 (H).
Step 04 FASTEN THE BACK PANELS WITH 8x8 NAILS (H).
Paso 04 FIJE LOS PANELES TRASEROS CON CLAVOS 8x8 (H).

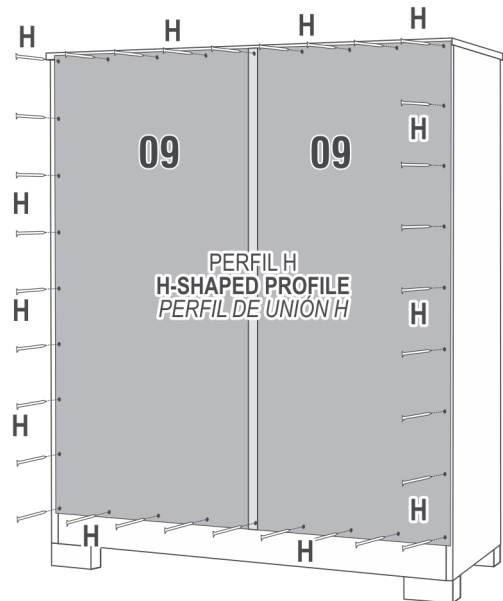

VISTA TRASEIRA
BACK VIEW
 VISTA TRASERA



H = 39

Passo 05 MONTE AS GAVETAS COM AS RESPECTIVAS FERRAGENS.

Step 05 ASSEMBLE THE DRAWERS WITH THEIR HARDWARE.

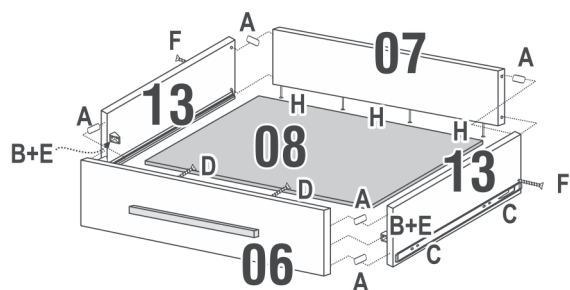
Paso 05 ARME LOS CAJONES CON SUS HERRAJES.



A = 24  B = 08  C = 16 

D = 08  E = 16  F = 08 

H = 16 

Passo 06 COLOQUE AS GAVETAS MONTADAS.

Step 06 INSERT THE DRAWERS ASSEMBLED.

Paso 06 PONGA LOS CAJONES YA ARMADOS.



Passo 07 PRODUTO MONTADO.

Step 07 PRODUCT ASSEMBLED.

Paso 07 PRODUCTO ARMADO.

