

Sr Montador:
- Confira todas as peças das embalagens com a lista de peças contida neste manual;
- Separe os acessórios, confira as medidas dos parafusos com a escala;
- Siga todas as orientações deste manual de montagem para ter o direito à garantia do produto;
- Indicamos que a montagem seja feita por um profissional mediante a leitura e orientação desse manual de montagem

Mr. Assembler:
- Check all parts of the packages with the parts list contained in this manual;
- Separate the accessories, check the measurements of the screws with the scale above;
- Follow all the instructions in this assembly manual to be entitled to product warranty;
- We indicate the assembly by a professional according to the reading and orientation contained in the assembly scheme

Sr Montador:
- Verifique que todas las piezas de la lista están incluidas en el embalage;
- Separe los accesorios, confirme las medidas de los tornillos de acuerdo con la escala;
- Siga todas las instrucciones de este manual de armado para tener derecho a la garantía del producto;
- Indicamos el armado por un profesional según la lectura y orientación contenida en el esquema de armado



Código da Peça
Piece Code
Código de la Pieza
-00000 0 00 -00
Padrões de Cor
Color default
Padrón de Color

Vídeo de Montagem
Assembly

Tabela de Cor	
Grafite	11

Guarde a etiqueta colada na embalagem do produto lá estão informações importantes do seu produto, caso necessite de assistência técnica você precisa informar o número do lote contido na etiqueta.

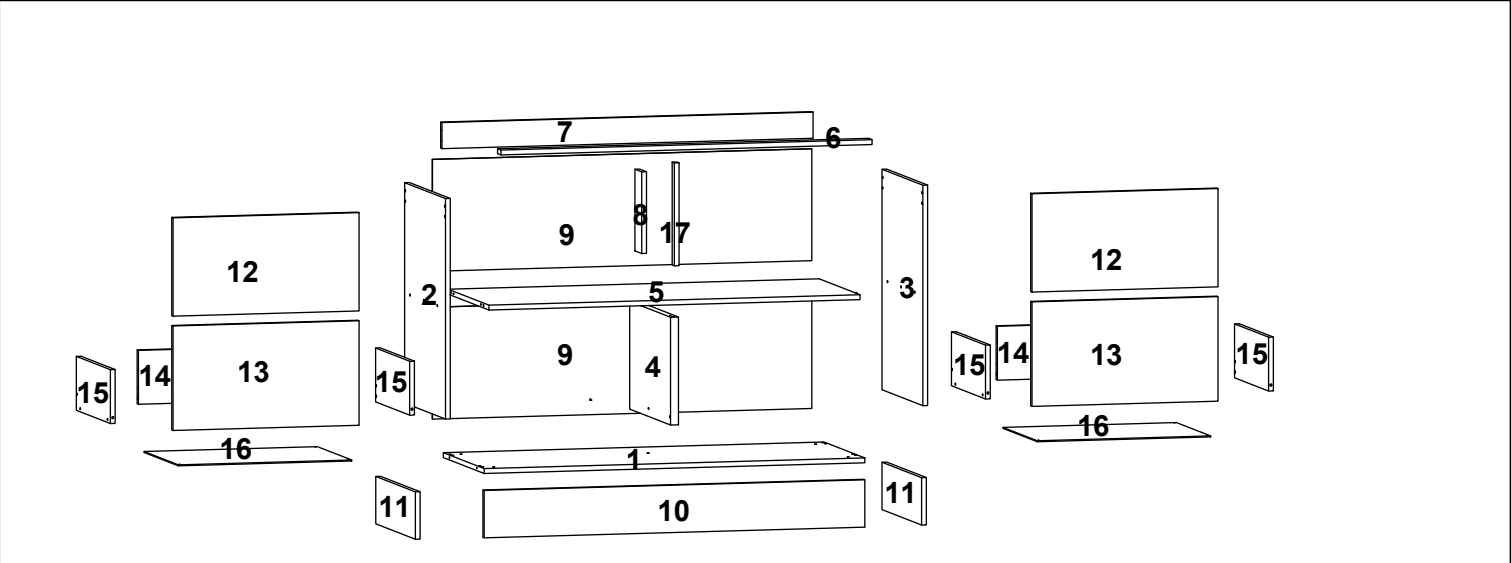

CÓDIGO	SEQ	DESCRICAO	DESCRIPTION	DESCRIPCIÓN	QTD	COMP	LARG	ESP
12536103	1	Base	Base	Base	1	1200	480	15
12536110	2	Lateral Esquerda	Left Side	Lado Izquierdo	1	675	480	15
12536109	3	Lateral Direita	Right Side	Lado Derecho	1	675	480	15
12536105	4	Divisoria	Division	Divison	1	330	480	15
12536113	5	Prateleira	Shelf	Estante	1	1169	480	15
12536116	6	Vista Frontal	Front Sight	Vista Frontal	1	1169	40	15
12536117	7	Vista Traseira	Back Sight	Vista Trasera	1	1169	40	15
12536119	8	Batente Traseiro	Back Column	Batiente Trasero	1	317	80	15
12536107	9	Fundo	Bottom	Fondo	2	196	343	3
12536114	10	Rodape Frontal	Front Baseboard	Zocalo Frontal	1	1200	145	15
12536115	11	Rodape Lateral	Side Baseboard	Zocalo de Lado	2	465	145	15
12536112	12	Porta	Door	Puerta	2	301	587	15
12536106	13	Frente Gaveta	Front of Drawer	Frente de Cajón	2	587	315	15
12536104	14	Contra Fundo Gaveta	Back of Drawer	Trasera de Cajón	2	422	165	15
12536111	15	Lateral Gaveta	Side of Drawer	Lado de Cajón	4	400	165	15
12536108	16	Fundo Gaveta	Drawer Bottom	Fondo de Cajón	2	551	403	3
12536118	17	Batente Frontal	Front Column	Batiente Frontal	1	317	40	15

Aspecto Final - Imagens ilustrativa
Final Aspect - Illustrative images
Aspecto final - Imágenes ilustrativas

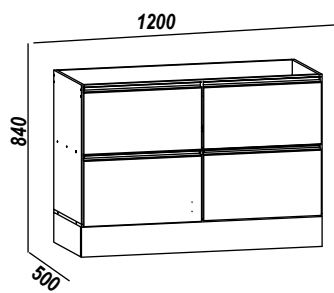

Medida Final /Final Measure

Medidas Internas
Internal Measures

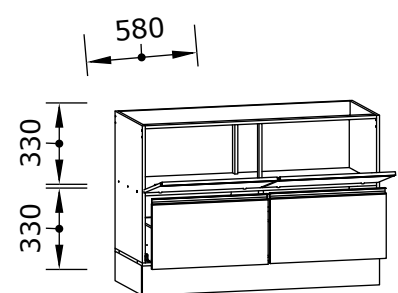

Desenho - Apds - Edição - A4 - Data - 23/02/2023

Pesos Suportados
Supported Weights
Pesos admitidos

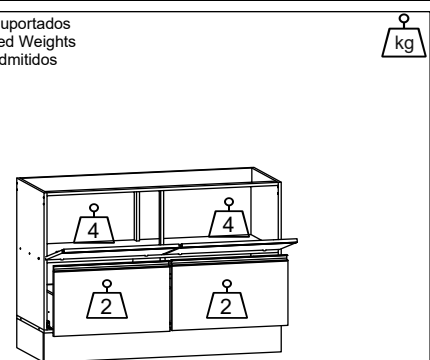

Os pesos indicados devem ser distribuídos em toda a peça
The weights indicated should be distributed throughout the piece
Los pesos indicados deben distribuirse por toda la pieza

Utilizar a régua para medir os componentes



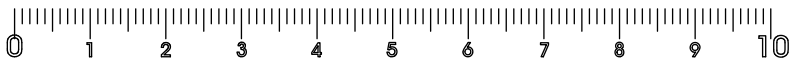









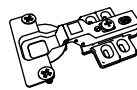

Utilice la medida abajo para medir los componentes
Use the ruler in order to measure the following components

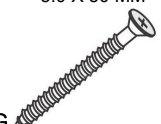

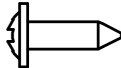
Passos da Montagem

Pasos del montaje / Mounting Steps

Todos os parafusos da tabela são do tipo Philips
All screws in the table are Philips type.
Todos los tornillos de la mesa son tipo Philips.

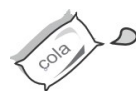
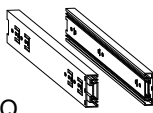
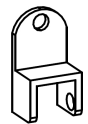
Parafuso Chato 4,5x45mm  A 24X	Parafuso Chato 4.0x14mm  B 108X	Cavilha madeira 6x30mm  C 16X	Prego 10x10mm  D 48X	Dobraçã Metal 35Ø  E 4X	Parafuso Chato 3,5X25MM  F 8X	PARAFUSO CHATO 5.0 X 50 MM  G 5X
Junção de Fundo 12x12mm  H 8X	Logo 35x15mm  I 1X	Parafuso Flangeado 4,0x14mm  J 18X	Pé plástico Cinza 145x42mm  K 5X	kit Pistão a Gás 60n Inverso  L 2X	Cantoneira Metal 18x18mm  M 12X	Puxador Perfil 587mm  N 4X
Fixador Rodape PVC 40x42x16mm  Branco 6X	Sache de Cola 10Gr  P 1X	Corrediça 400mm Telescópica Light  Q 2X	Suporte Plastico Caderinha de 15mm  R 2X			

PASSO 1

PASO/STEP

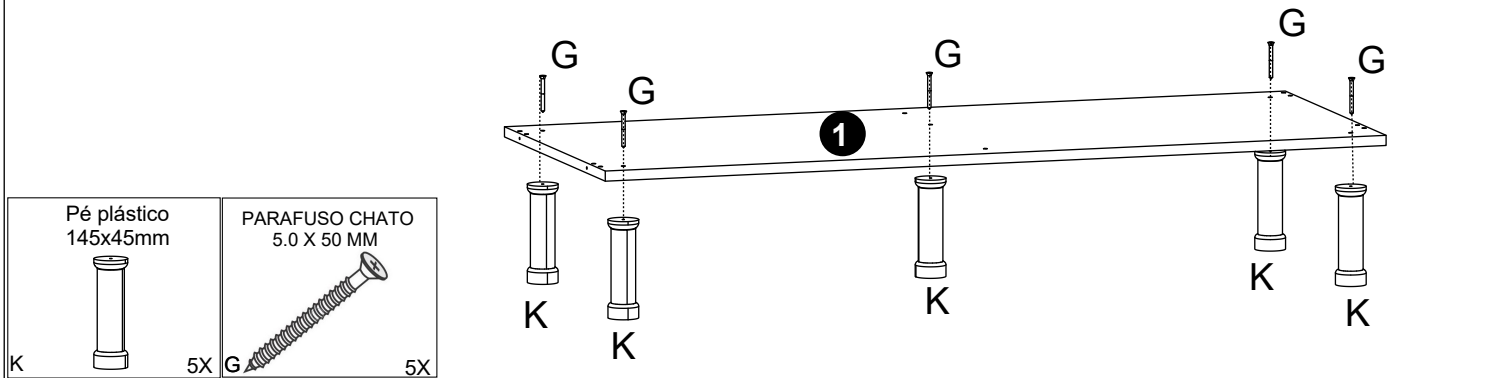

PASSO 2

PASO/STEP

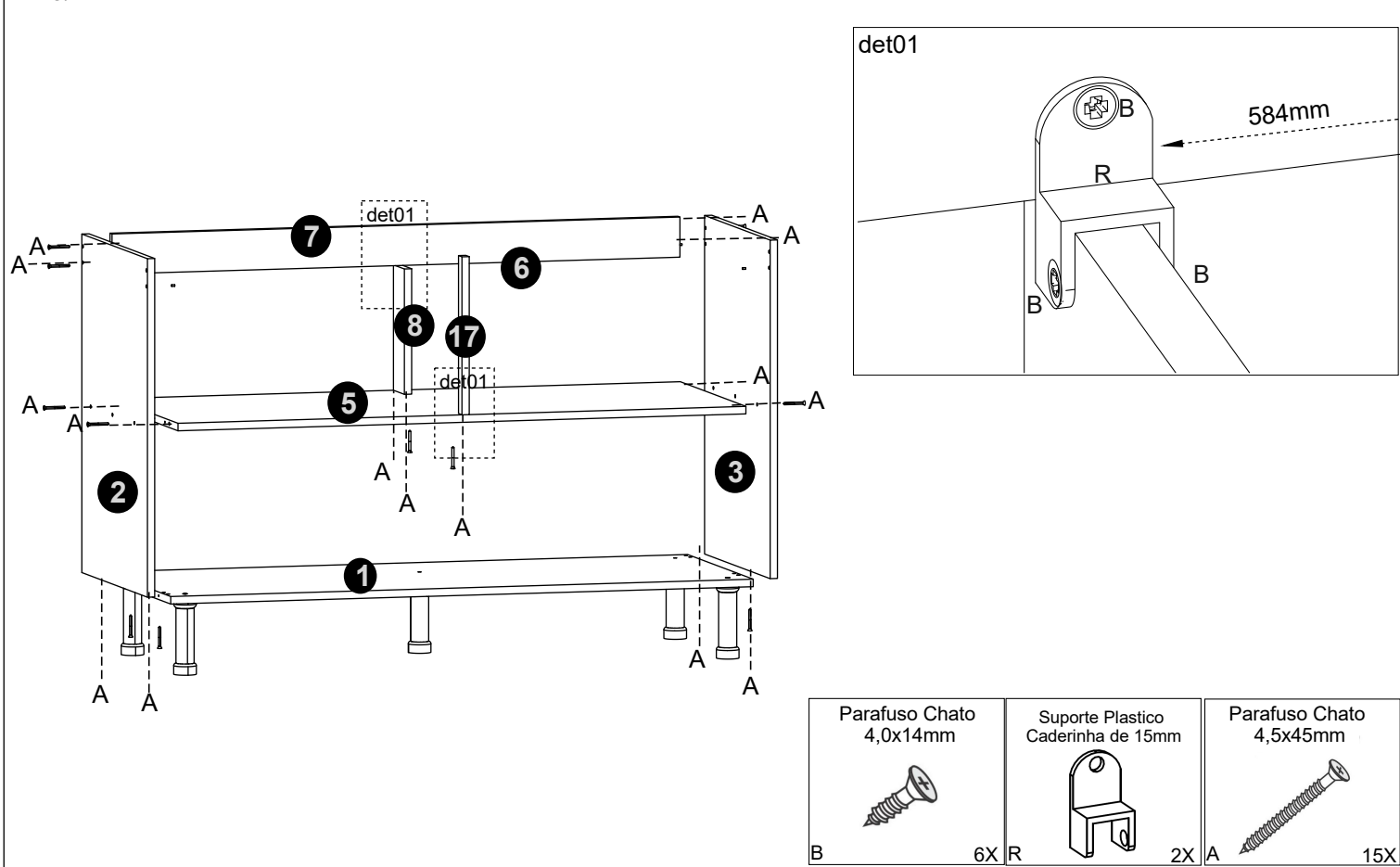

PASSO 3
PASO/STEP

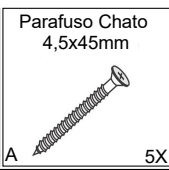
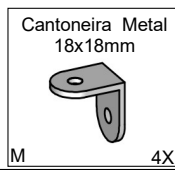
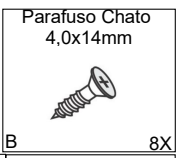
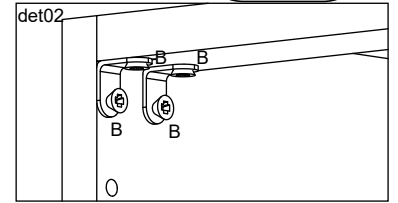
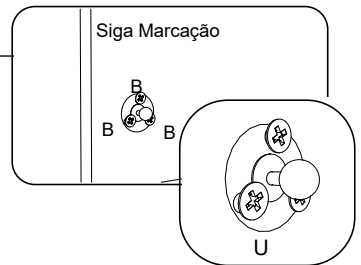
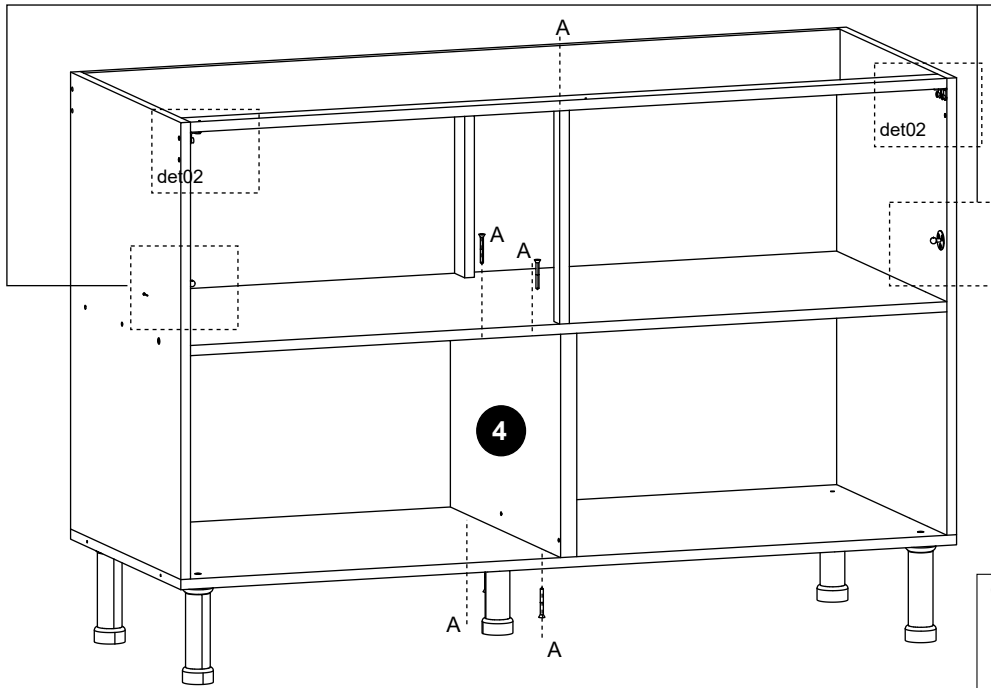

PASSO 4
PASO/STEP

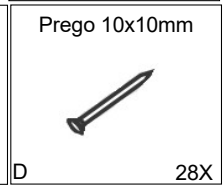
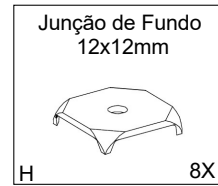
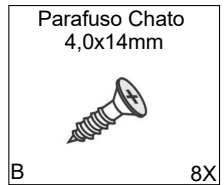
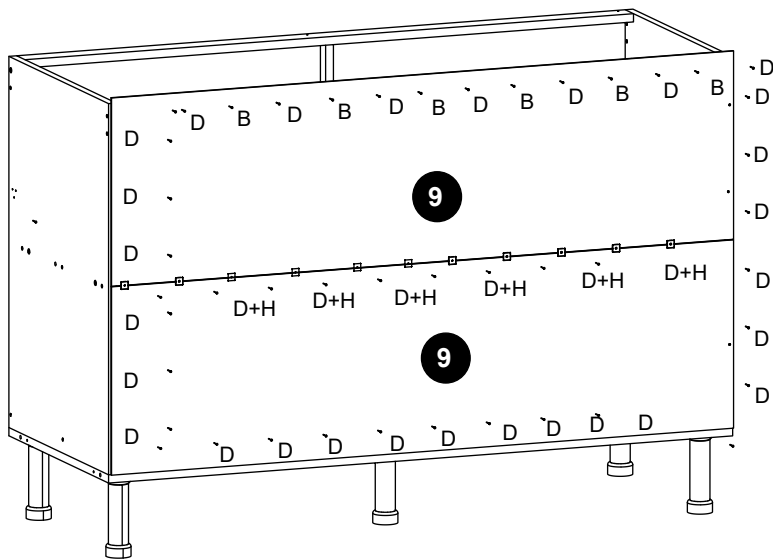

PASSO 5
PASO/STEP

Preparação fixador do Rodapé

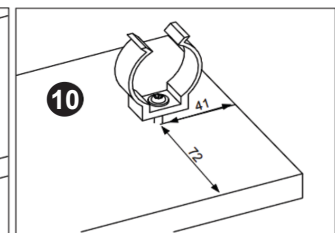
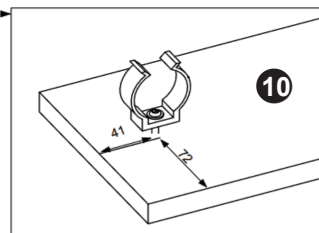
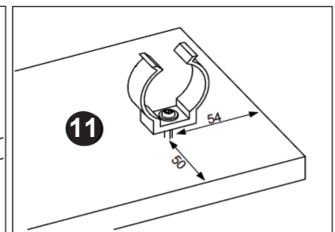
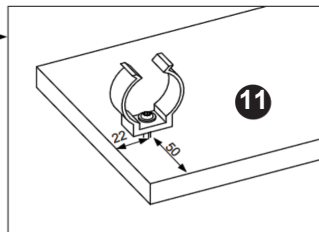
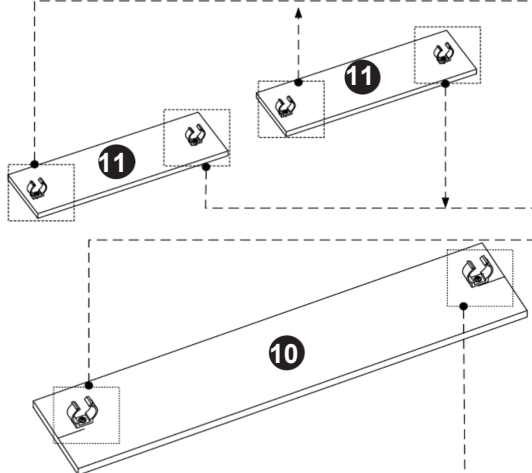

Use trena e Lápis para as marcações seguindo esquema acima e fixe o acessório usando parafuso

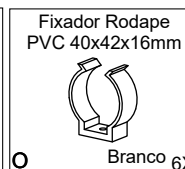
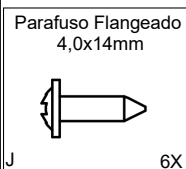

Passo 6
Paso /Step

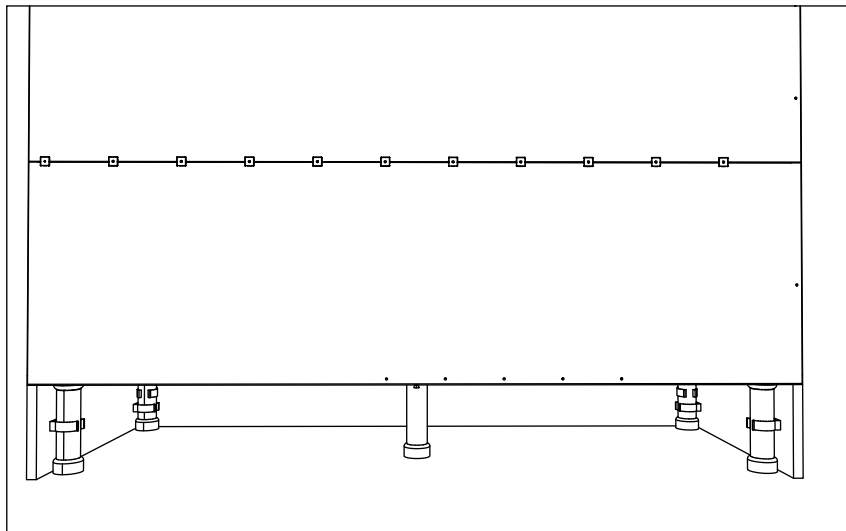

Encaixe os rodapé lateral primeiro, e depois fixe o rodapé da frente.

Fit the side skirting first, then fix the front skirting

Coloque primero el zócalo lateral y luego fije el zócalo delantero.

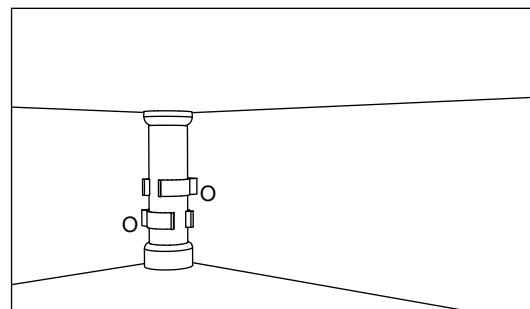

Passo 7
Paso /Step

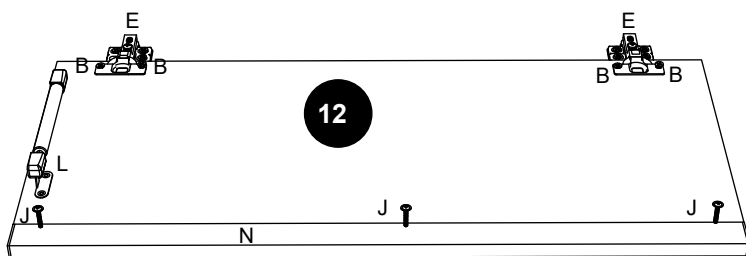

Parafuso Flangeado 4,0x14mm

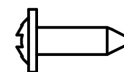

J

6X

Parafuso Chato 4,0x14mm



B

8X

kit Pistão a Gás 60n Inverso



L

2X

Puxador Perfil 589mm



N

2X

Dobradiça Metal 35Ø



E

4X

Passo 8
Paso /Step

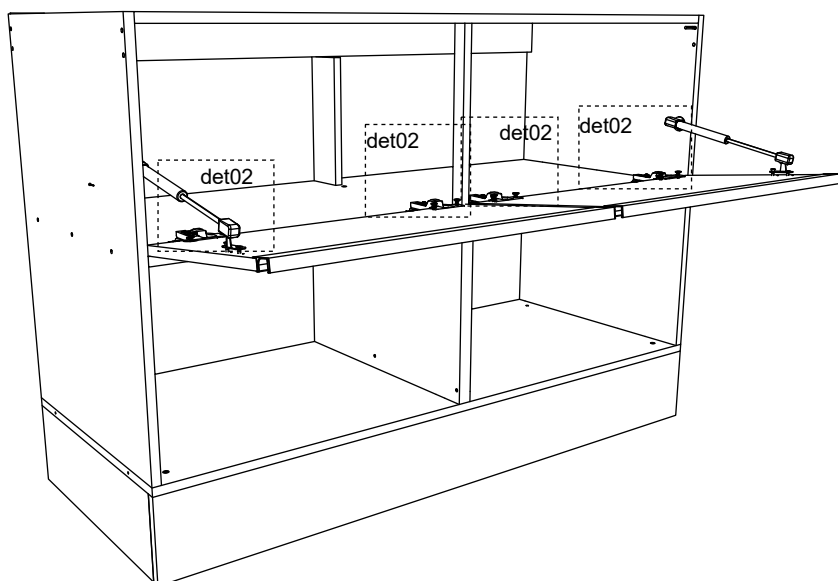

det02

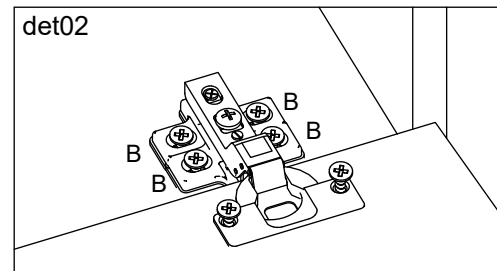

Fixação do Pistão (L).

Piston Fixing (L).

Fijación Pistón (L).

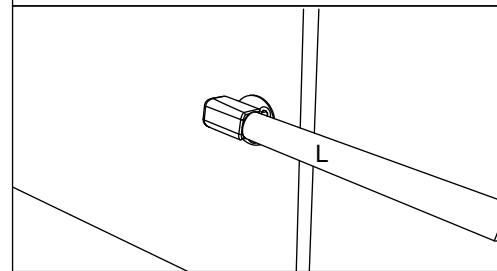

Parafuso Chato 4,0x14mm



B

16X

kit Pistão a Gás 60n Inverso



L

2X

Passo 9
Paso /Step

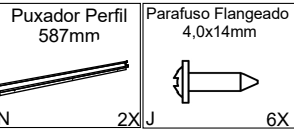

Montagem das Gavetas Assembly of Drawers Montaje de los cajones

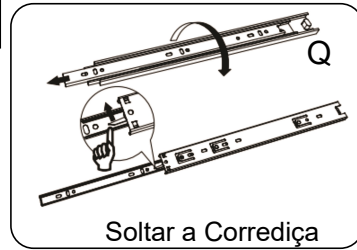

Lateral de Gaveta menor
(no contra fundo 1 cavilha de cada lado)

Lateral de Gaveta Maior
(no contra fundo 2 cavilha de cada lado)

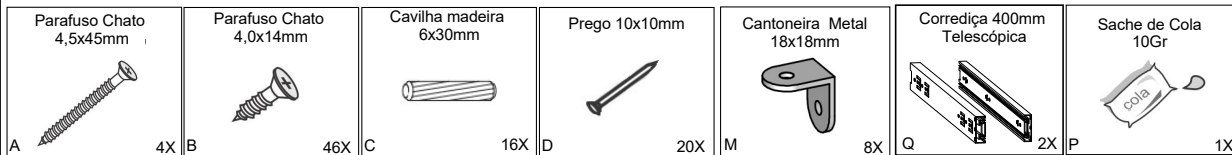
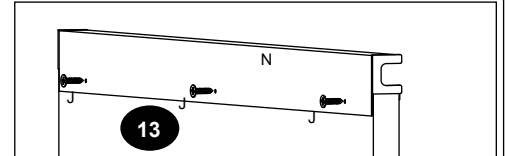
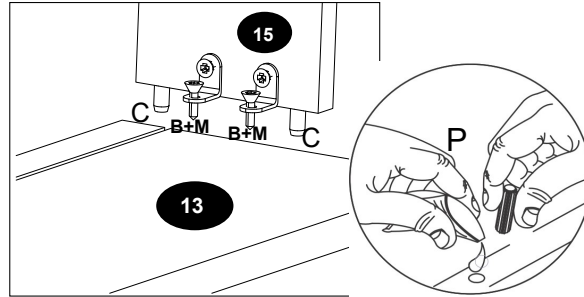
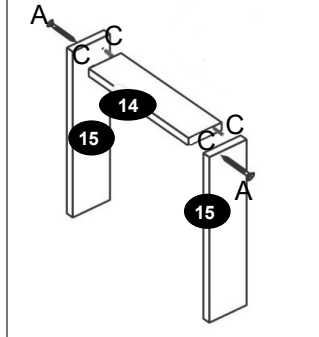
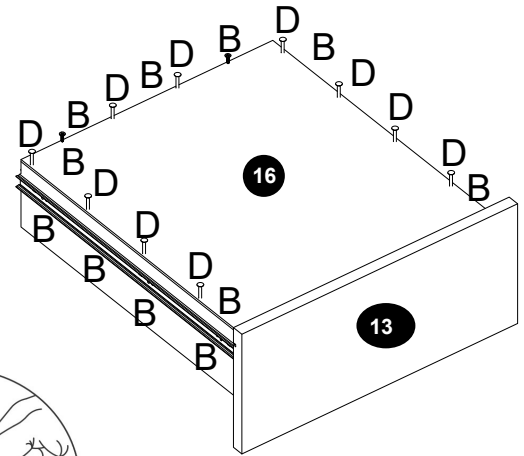

Passo 10
Paso /Step

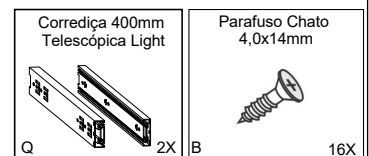
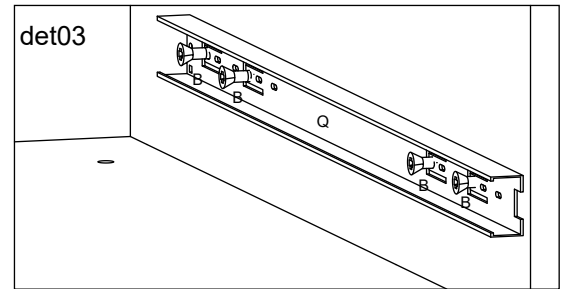
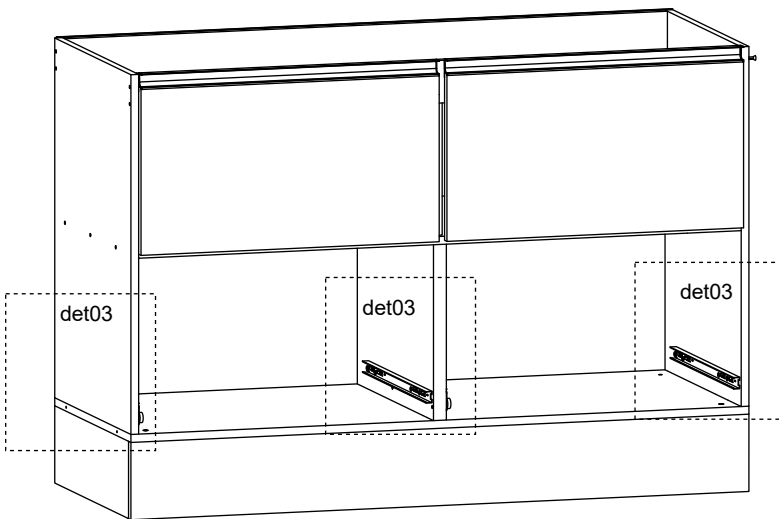

Passo 11
Paso /Step

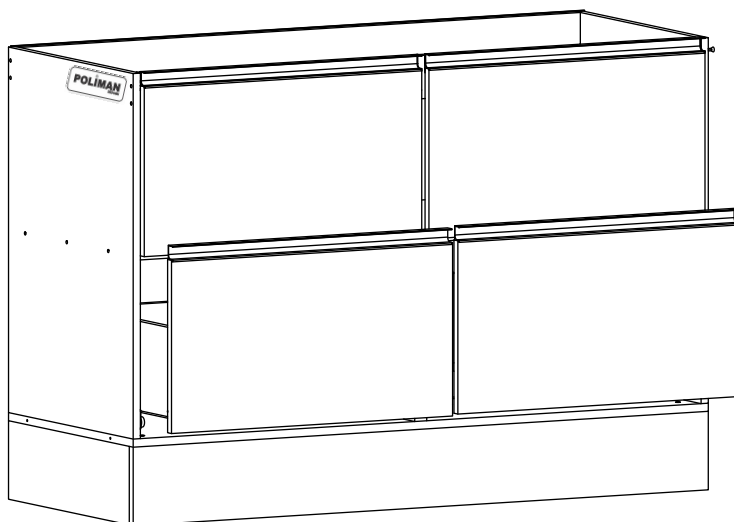

Encaixe as gavetas
Fit the drawers
Encajar los cajones

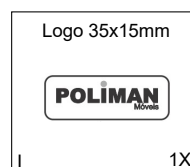

Use parafuso F para unir sempre os módulos.
Use screw F to join always modules
Utilice el tornillo F para unir siempre módulos.

Termo de Garantia / Renúncia de Garantia / Warranty Term



sac@poliaman.ind.br



Data de Emissão
Fecha de Expedición
Date of Issue _____

Cliente / Client _____

Vendedor /Loja
Vendedor/ Tienda
Seller/ Store

Dicas de conservação / Dicas para Conservación / Conservation Tips

Para limpar ou tirar manchas, utilize uma flanela umedecida em solução de água e álcool, na mesma proporção *Evite exposição ao sol.	Para limpiar o retirar manchas, utilice un paño humedecido en una solución de agua y alcohol, en la misma proporción. *Evite la exposición directa al sol..	To clean or remove stains, use a flannel moistened with water and alcohol solution in the same proportion. *Avoid sun exposure.
---	--	--

Poliman Indústria e Comércio de Móveis Ltda., garante este produto (peças e mão de obra, por defeitos de fabricação), pelo prazo de noventa dias a partir da data de emissão da nota fiscal de venda do produto ao consumidor.

Poliman Indústria e Comércio de Móveis Ltda. Garantiza este producto (piezas y mano de obra debido a defectos de fabricación), por un período de noventa días a partir de la fecha de emisión de la factura de venta del producto al consumidor.

Poliman Indústria e Comércio de Móveis Ltda. Warrants this product (parts and labor due to manufacturing defects), for a period of ninety days from the date of issuance of the sales invoice of the product to the consumer.

Termo de Garantia Contratual/ Documento de Garantía Contractual/ Contractual Warranty Term

- 1) Apresentar este certificado de garantia acompanhado do recibo de compra do local de aquisição do produto.
- 1) Presente este certificado de garantía junto con el recibo de compra del establecimiento.
- 1) Submit this certificate of guarantee accompanied by the purchase receipt of the place of purchase of the product.
- 2) Esta garantia perderá sua validade mesmo dentro do prazo acima estipulado se:
- 2) Esta garantía perderá su validez, incluso dentro del plazo arriba estipulado en los siguientes casos:
- 2) This warranty will lose its validity even within the above time limit if:
 - O produto apresentar danos por mau trato, acidente, uso diferente do indicado ou uso em condições ambientais deficientes (contato direto com água, fogo, etc.);
 - Si el producto está dañado por abuso, accidente, mal uso, uso diferente al indicado o utilizado en condiciones ambientales deficientes (contacto directo con agua, fuego, etc.);
 - The product presents damages due to ill-treatment, accident, use other than the indicated one or use in terms of environment deficient (direct contact with water, fire, etc.);
 - Os vidros e espelhos quebrarem ou trincarem após a entrega e montagem dos produtos;
 - Cuando los vidrios y espejos se rompan se rallen después de la entrega y el montaje de los productos;
 - Glasses and mirrors break after delivery and assembly of the products;
 - Quando o produto não for montado por profissionais devidamente treinados pelo revendedor;
 - Cuando el producto no sea instalado por profesionales debidamente entrenados por el concesionario;
 - When the products is not assembled by professionals properly trained by the dealer
 - Dobradiças, corrediças e puxadores somente terão sua garantia quando apresentarem defeitos de fabricação.
 - Bisagras, correderas y tiradores sólo tendrán garantía cuando presenten defectos de fabricación.
 - Hinges, slides and handles are only warranted when they have manufacturing defects
 - O consumidor exceder o limite de peso estipulado para cada parte do produto, conforme especificado no Manual de Montagem.
 - Cuando el consumidor supere el límite de peso estipulado para cada uno de los productos, tal como se especifica en el Manual de Instalación.
 - The consumer exceeds the stipulated weight limit for each part of the product as specified in the Assembly Manual.
- 3) Todo e qualquer produto com avarias deverá ser feito vistoria por parte do técnico autorizado pelo revendedor e indústria. Em hipótese alguma será realizada a troca total do produto.
- 3) Cualquier producto con daños debe ser inspeccionado por un técnico autorizado por el distribuidor y la fábrica. En ningún caso se llevará a cabo el cambio completo del producto.
- 3) Any product with faults should be inspected by the dealer authorized technician and industry. Under no circumstances will the total exchange of the product be carried out

Código Defesa do Consumidor / Código de Defensa del Consumidor / Consumer Defense Code

<p align="center">ATENDIMENTO DE PEÇAS</p> <p>Art. 18. Os fornecedores de produtos de consumo duráveis ou não duráveis respondem solidariamente pelos vícios de qualidade ou quantidade que os tornem impróprios ou inadequados ao consumo a que se destinam ou lhes diminuam o valor, assim como por aqueles decorrentes da disparidade, com a indicações constantes do recipiente, da embalagem, rotulagem ou mensagem publicitária, respeitadas as variações decorrentes de sua natureza, podendo o consumidor exigir a substituição das partes viciadas.</p> <p>§ 1º Não sendo o vício sanado no prazo máximo de trinta dias, pode o consumidor exigir, alternativamente e à sua escolha:</p> <p>I - a substituição do produto por outro da mesma espécie, em perfeitas condições de uso; II - a restituição imediata da quantia paga, monetariamente atualizada, sem prejuízo de eventuais perdas e danos; III - o abatimento proporcional do preço.</p>	<p align="center">REPOSICIÓN DE PIEZAS</p> <p>ART. 18. Los proveedores de productos de consumo duraderos o no duraderos responden, solidariamente, de los vicios de calidad o cantidad que los tornen improprios o inadecuados para el consumo al que se destinan o disminuyan su valor, así como de aquellos que sean resultado de la disparidad con las indicaciones que constan en el recipiente, embalaje, rotulado o mensaje publicitario, respetando las variaciones derivadas de la naturaleza de producto, pudiendo el consumidor exigir la sustitución de las partes viciadas.</p> <p>1º No siendo el vicio subsanado en el plazo máximo de 30 días, el consumidor puede exigir alternativamente y en su elección:</p> <p>I - La sustitución del producto por otro de la misma especie en perfectas condiciones de uso; II - La restitución inmediata del importe pagado, con actualización monetaria, sin perjuicio de las eventuales pérdidas y daños; III - La reducción proporcional del precio..</p>	<p align="center">PARTS ASSISTANCE</p> <p>Art.18 - Suppliers of durable or non-durable consumer products are jointly and severally liable for quality or quantity which renders them unfit or unsuitable for the intended use or which diminish their value, as well as those arising from the disparity, the particulars in the container, the packaging, the labeling or the advertising message, subject to variations due to their nature, and the consumer may require the replacement of the defective parts.</p> <p>§ 1º - If the defect is not remedied within a maximum of thirty days, the consumer may, alternatively and at his choice, request: I - the replacement of the product with another of the same species, in perfect conditions of use; II - the immediate return of amount paid, monetarily updated, without prejudice to any losses and damages; III - the proportional reduction of the price.</p>
--	---	--

<p align="center">GARANTIA LEGAL</p> <p>Art. 26. O direito de reclamar pelos vícios aparentes ou de fácil constatação caduca em:</p> <p>II - noventa dias, tratando-se de fornecimento de serviço e de produtos duráveis.</p>	<p align="center">GARANTIA LEGAL</p> <p>Art. 26. El derecho de reclamar por los vicios aparentes o de fácil constatación caduca en:</p> <p>II - Noventa días, tratando-se de suministros de servicios y productos duraderos.</p>	<p align="center">LEGAL GUARANTEE</p> <p>Art. 26. The right to complain about apparent or easily found defects expires in:</p> <p>II - ninety days, in the case of service provision and durable products.</p>
--	---	---