



PAINEL HOME COMPAQ

DIMENSÕES DO PRODUTO L x P x A -900x30x680

ATENÇÃO: VÍDEO DE MONTAGEM DISPONÍVEL NO SITE

www.olivar.com.br

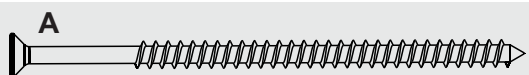
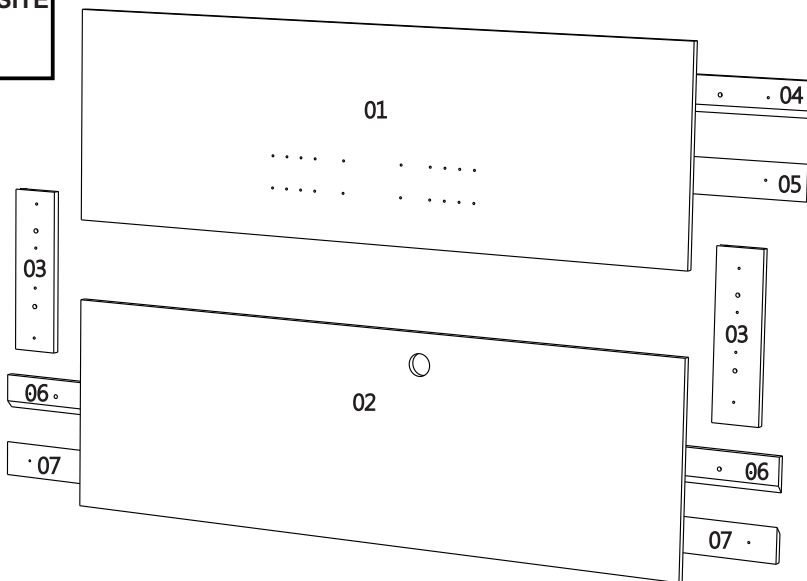
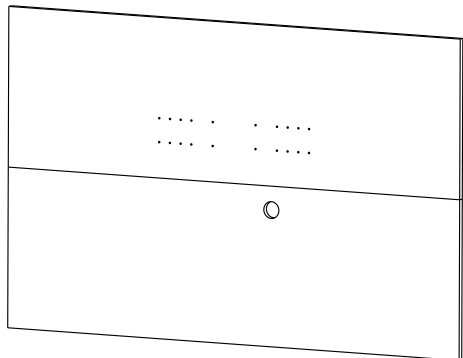

PARAFUSO 4,8x75 CH(07)



BUCHA PLÁSTICA 8x50(07)



PARAFUSO 3,5x25 FL (15)



PARAFUSO 3,5x14 CRR(08)



CAVILHA 8x20(10)



PASSA FIO(01)

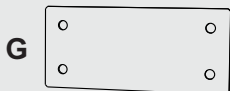

FIXADOR AÇO 80X35 MM(02)

ITEM	DESCRIÇÃO DAS PEÇAS						CORES				
	CÓD	Nº	NOME	MEDIDAS	TIPO	QUANT	BCO	PTO	VERM	CAST	TURQ
8239	01	Painel Superior	900X340X15	MDP	1	1/05	1/07	1/09	1/19	1/21	
8240	02	Painel Inferior	900X340X15	MDP	1	2/05	2/07	2/09	2/19	2/21	
8241	03	Reforço Traseiro	290X80X15	MDP	2	3/05	3/07	3/09	3/19	3/21	
8242	04	Régua Fixa Superior	680X70X15	MDF	1						
8243	05	Régua Avulsa Superior	680X70X15	MDF	1						
8244	06	Régua Fixa Esq/Dir	290X70X15	MDF	2						
8245	07	Régua Avulsa Esq/Dir	290X70X15	MDF	2						
8	A	Parafuso Philips 4,8x75 CH Zincado			7						
2922	B	Bucha Plástica 8x50 Cinza			7						
8233	C	Parafuso Philips 3,5x25 FL			15						
986	D	Parafuso 3,5x14 CRR			8						
2921	E	Cavilha Pinus 8x20mm			10						
5785	F	Passa Fio c/ Trava 46 mm			01						
737	G	Fixador Aço 80X35 MM			02						
5264	H	Suporte Alumínio Painel (KIT TV)			1						
5691	I	Parafuso Philips M5x25 PN			4						
5592	J	Porca Sextavada M5 FE			4						
5591	K	Arruela Latão M6 Lisa			8						
5588	L	Parafuso Philips M4x16 PN			4						
5590	M	Parafuso F Reta M6x16			4						
5589	N	Parafuso F Reta M8x16			4						
5264	O	Suporte Alumínio Superior (KIT TV)			2						
5264	P	Suporte Alumínio Inferior (KIT TV)			2						
		Certificado Garantia			1						

OBS: AS CORES APRESENTADAS NOS PASSOS SÃO MERAMENTE ILUSTRATIVAS.

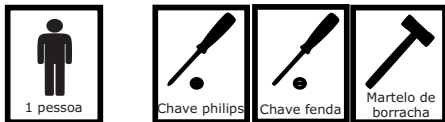

OBS: TODAS AS PEÇAS SÃO NUMERADAS.

EX: 1915X-X 01 (nº da peça)

PARA MAIOR SEGURANÇA MONTAR O PRODUTO NO CHÃO, SOBRE A EMBALAGEM, EVITANDO DANOS NA PINTURA.

CUIDADOS ESPECIAIS: LIMPEZA- Pano limpo umedecido em água e sabão neutro. BRILHO- Flanela seca.

ATENÇÃO

Nunca utilizar óleos, como lustra móvel; produtos abrasivos, como saponáceos, esponja de aço e outros.

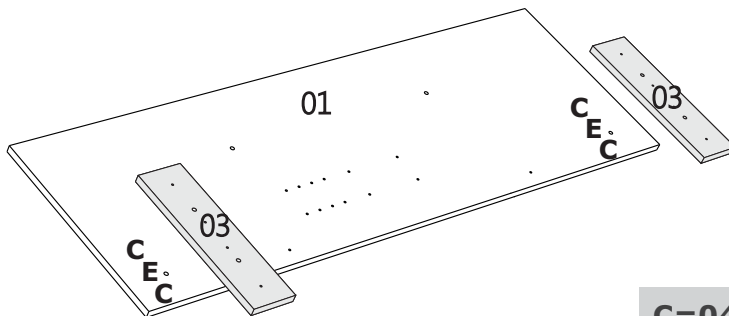

**C=04
E=02**

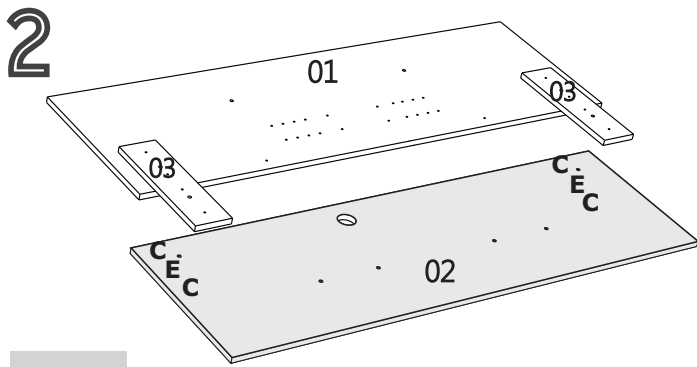

E=02
C=04

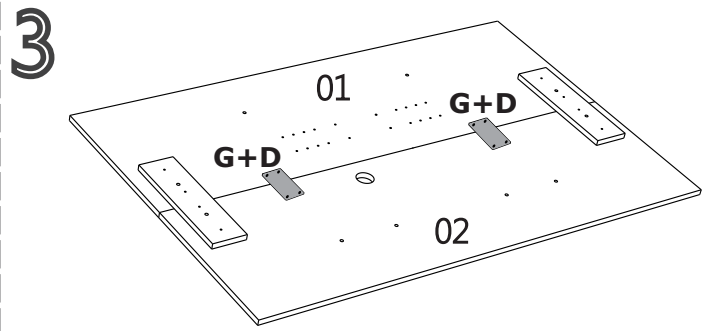

G=02
D=08

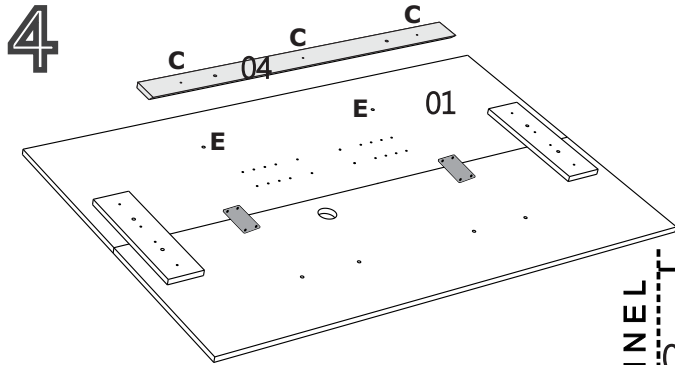
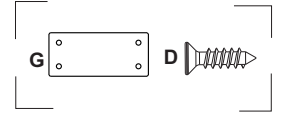

C=03
E=02

CHANFRO VIRADO PARA BAIXO

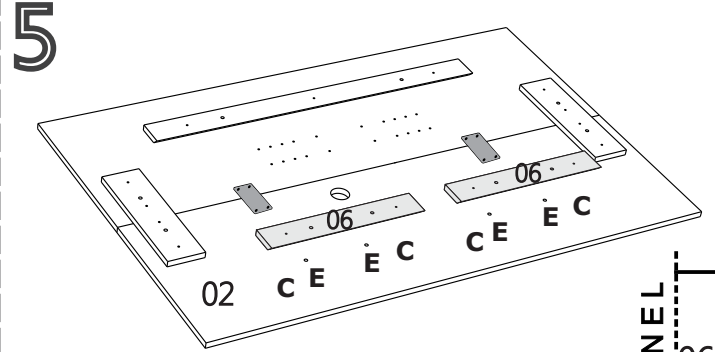

C=04
E=04

CHANFRO VIRADO PARA BAIXO

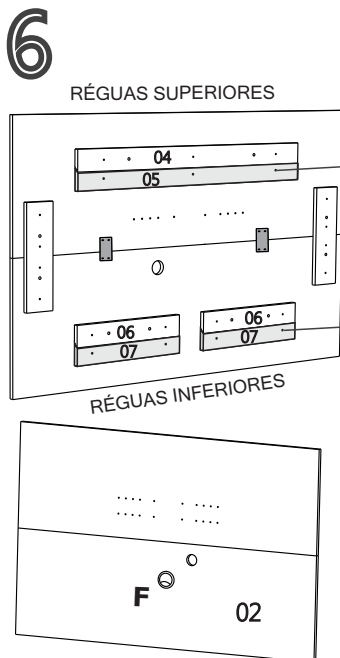
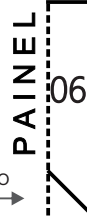

A=07
B=07
F=01

Confira a distância entre os furos das réguas avulsas, antes de fixá-las na parede.

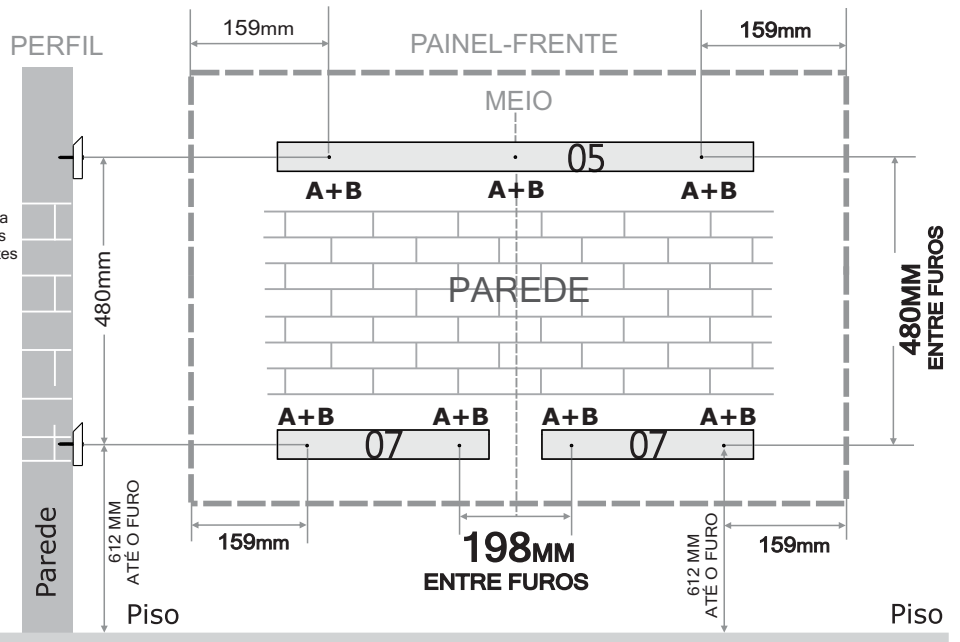

ATENÇÃO
Verifique se as réguas estão encaixadas corretamente.

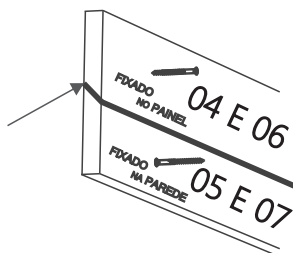

ATENÇÃO
A medida de 612 mm entre o piso e a furação da parede não é padrão. Fixando nesta medida o painel ficará a 551 mm do piso depois de montado. Optando em obter uma medida diferente, devido a altura do Rack aumentar ou diminuir a medida de 612 mm. Porém a medida entre os furos das peças 05, 07 e 07 deverá ser de 480 mm obrigatoriamente.

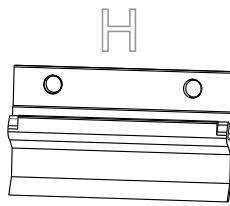
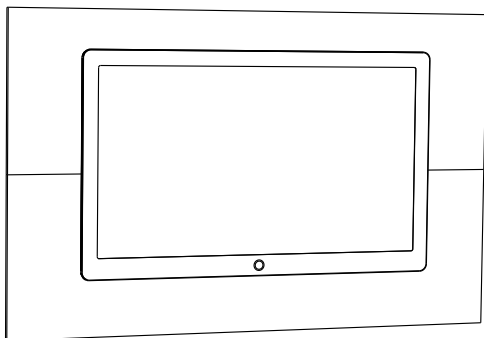

SUPORE PAINEL (02)

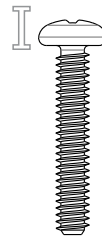

PARAFUSO P/ SUPORTE TV M5x25 (04)



PORCA P/ SUPORTE TV M5 (04)

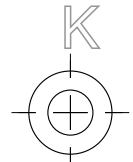

ARRUELA P/ SUPORTE TV 6,5x12 (04)

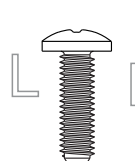

PARAFUSO P/ SUPORTE TV M4x16 (04)

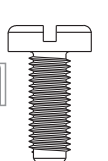

PARAFUSO P/ SUPORTE TV M6x16 (04)

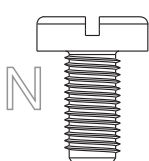

PARAFUSO P/ SUPORTE TV M8x16 (04)

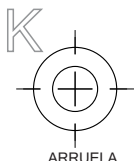

ARRUELA P/ SUPORTE DE TV 6,5x12 (04)

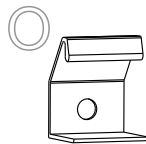

SUPORTE TV SUPERIOR (02)

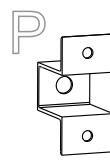

SUPORTE TV INFERIOR (02)



Sr. MONTADOR

Verifique com o cliente qual a TV que será instalada no painel. Após informação dê sequência na montagem dos suportes H. Disponibilizamos duas linhas de furos para diferentes tamanhos de TV: as maiores devem ser fixadas na linha superior e as menores na linha inferior.

1º passo

FURAÇÃO P/ SUPORTE H (PAINEL)

FURAÇÃO P/ SUPORTE H (PAINEL)

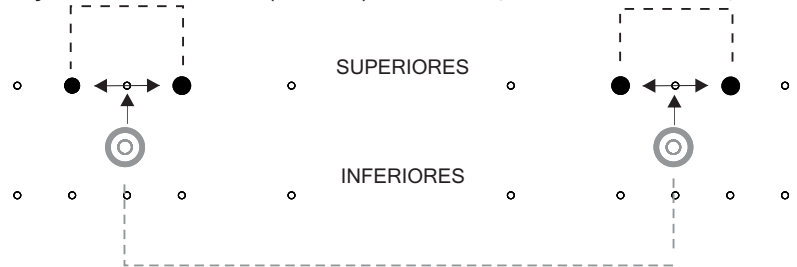

FURAÇÃO P/ SUPORTE O (TV)



4 PARAFUSO P/ SUPORTE DE TV M5x25 (C/ ARRUELA N)



4 PORCA P/ SUPORTE DE TV M5

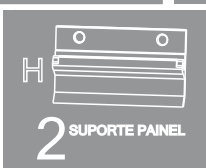

2 SUPORE PAINEL



4 ARRUELA P/ SUPORTE TV 6,5x12

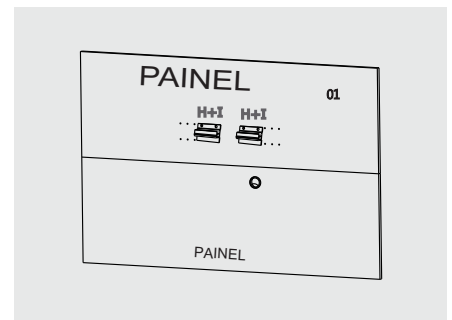
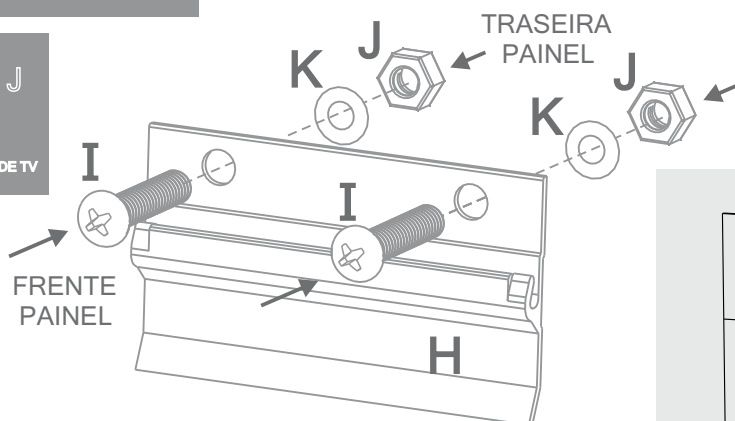

Sr. CLIENTE

2º passo

. Fixe os dois suporte O nos furos superiores na parte traseira da TV e os suportes P nos furos inferiores. Poderão ser utilizados 3 tipos de parafusos de acordo com sua TV :

- . Parafuso M8x16;
- . Parafuso M6x16;
- . Parafuso M4x16 (nesta medida serão indispensáveis o uso de Arruelas).

. Em seguida pendurar a TV no Painel encaixando o Suporte O (já fixado na TV) no Suporte H (já fixado no Painel pelo montador).

OBSERVE OS DESENHOS

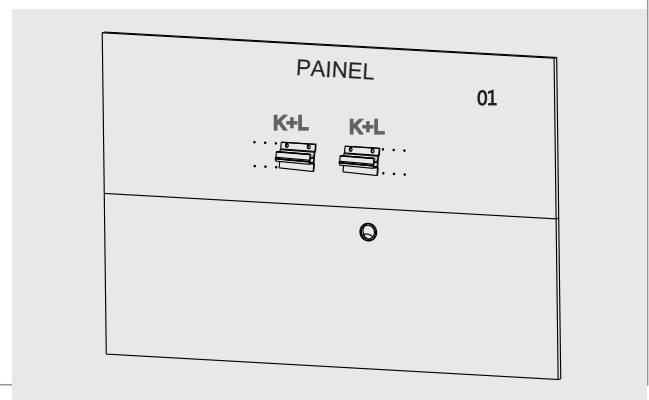
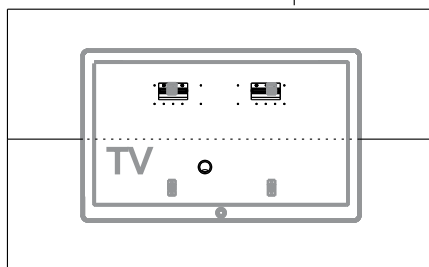
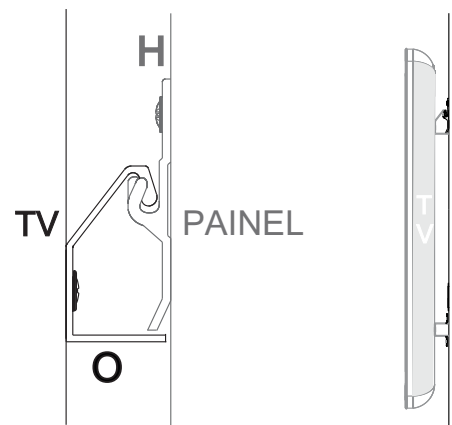
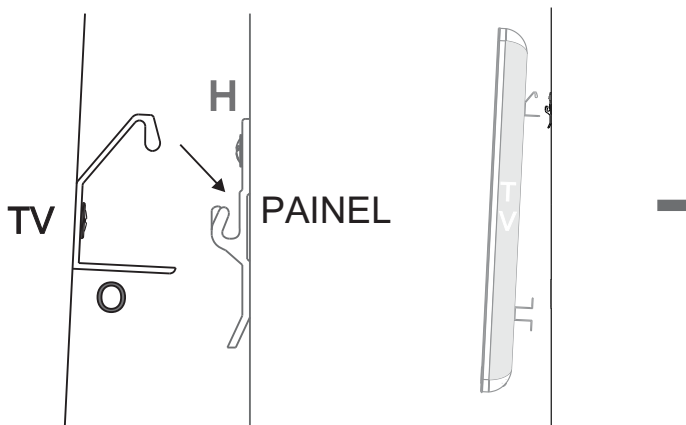
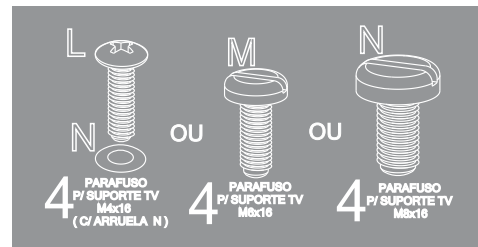
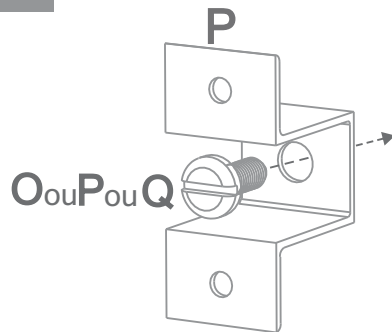
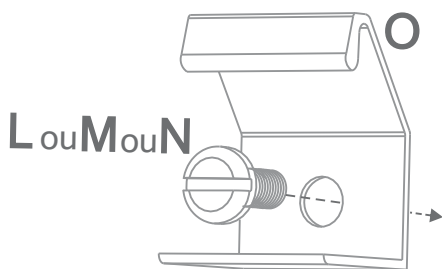
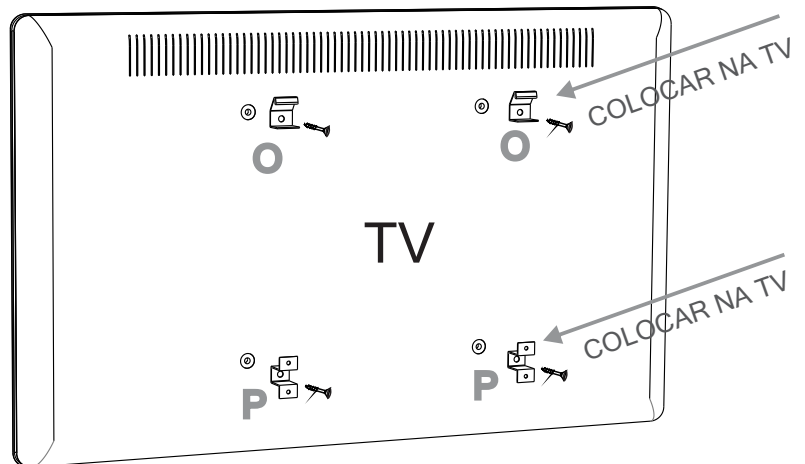

Obs: Se a sua TV não ficar centralizada no painel com a furação já existente no mesmo, poderá ser feita outra furação no painel para que possa centralizá-la.