



**MANUAL DE MONTAGEM
ASSEMBLY INSTRUCTIONS
INSTRUCCIONES DE MONTAJE**

COD BR: BL 03-06, BMU 103-06

Sumário Summary Resumen

Introdução Introduction Introducción	3
Antes de começar Before starting Antes de comenzar	4
Evite acidentes Avoid accidents Evitar accidentes	4
Dimensões e ferramentas Dimensions and tools Dimensiones y herramientas	5
Identificação das peças Identifying parts Identificación de las piezas	6
Acessórios incluídos na caixa Hardware included in box Accesorios incluidos en la caja	7
Montagem do móvel Furniture assembly Montaje del mueble	8

Introdução Introduction Introducción

Leia atentamente este manual e siga os passos indicados para que o produto não perca a garantia e também para uma perfeita montagem.

Read this manual and follow the steps in order to keep the guarantee and also for the perfect fit.

Lea este manual y siga los pasos para que el producto no pierda la garantía y también para el ajuste perfecto.

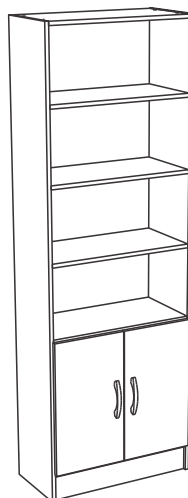

Antes de começar Before starting Antes de comenzar

Antes de começar a montagem prepare o ambiente, deixando-o completamente limpo e com bom espaço para iniciar o trabalho.

Prepare the room before starting the assembly, leaving it completely clean and the area in good condition to start the work.

Antes de comenzar el montaje preparar el ambiente, dejándolo completamente limpio y con bueno espacio para comenzar el trabajo.

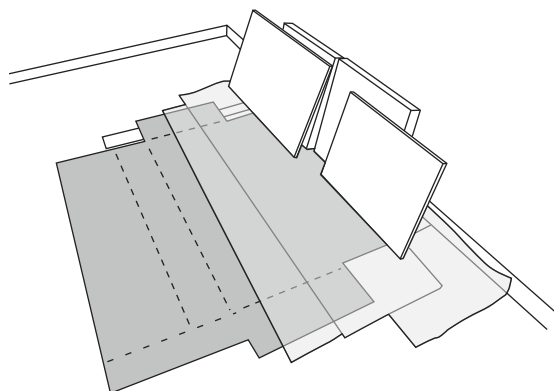

Utilize o papelão da própria embalagem para separar e apoiar as peças retiradas das caixas.

Use the cardboard of the packaging to separate and support the parts removed from the boxes.

Utilice el cartón de la embalaje para separar y apoyar las piezas desmontadas de las cajas.



Forre a área de montagem com um cobertor ou tapete. Assim, você evita avarias nas peças durante o processo de montagem.

Cover the assembly area with a blanket or carpet to avoid damaging the parts during the assembly process.

Cubrir la zona de ensamble con una manta o alfombra. De este modo, se evitan daños en las piezas durante el proceso de montaje.



Evite acidentes Avoid accidents Prevenir accidentes

Solicitamos observar atentamente as orientações de montagem como: fixação do produto na parede, colocação de cola em locais específicos necessários, o peso suportado pelo produto, etc...

We request you to carefully observe the assembly instructions as: fixing the product on the wall, adding glue in needed and specific places, product weight limit, etc.

Pedimos que lea atentamente las instrucciones, principalmente las informaciones de fijación del producto en la pared, colocación de pegamento en local específico y necesario, el peso soportado por el producto etc...

Não escale ou se apoie no móvel.

Do not climb or lean on the furniture.

No se suba ni se apoye en el mueble.

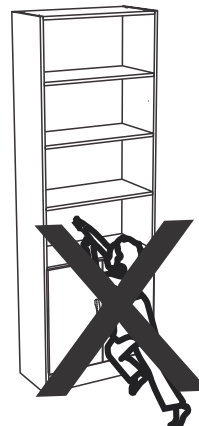

Dimensões e ferramentas
Dimensions and tools
Dimensiones y herramientas

Dimensões:

L: 615 A: 1825 P: 305 mm

Dimensions:

W: 24.21 H: 71.85 D: 12.00 inches

Dimensiones:

L: 615 A: 1825 P: 305 mm

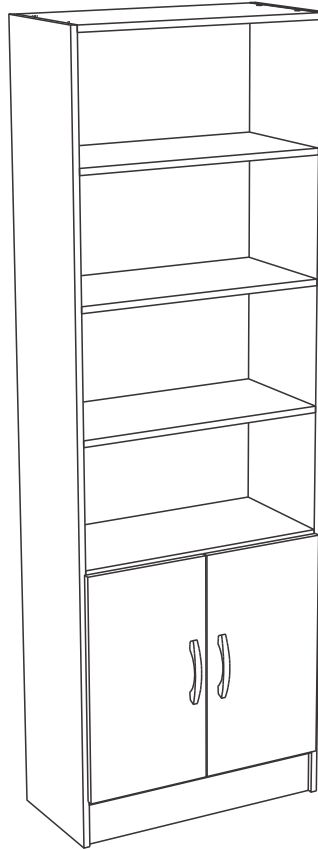

Limpeza
Cleanig
Limpieza

Pano levemente umedecido com água, seguido de pano seco, não utilizar produtos químico ou abrasivos.
Slightly dampened cloth and after a dry cloth, do not use chemicals or abrasives.

Solamente utilizar un paño húmedo y después un paño seco, no utilice productos químicos o abrasivos.

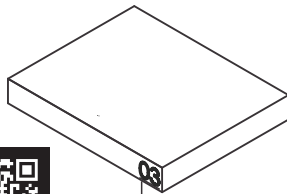

UTILIZE ALCOOL APENAS PARA REMOVER O NUMERO DAS PEÇAS
USE ALCOHOL ONLY TO REMOVE PART NUMBERS

UTILICE ALCOHOL SOLAMENTE PARA ELIMINAR EL NUMERO DE LAS PIEZAS

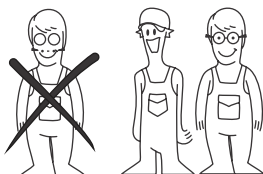

Para facilitar a montagem, utilize uma parafusadeira elétrica.
To improve assembly, use an eletronic screwdriver.
Para facilitar el armado, utilice un destornillador eléctrico.

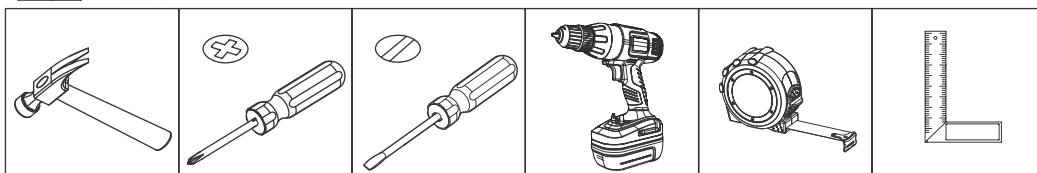

COD BR: BL 03-06, BMU 103-06

PEÇA	DESCRIÇÃO	QUANT.
002	LATERAL	2
003	PRATELEIRA	6
004	COSTA MAIOR	4
005	COSTA MENOR	2
006	PORTA	2
007	RODAPE	1

PART	DESCRIPTION	QTY
002	SIDE	2
003	SHELF	6
004	LONGER BACK	4
005	LOWER BACK	2
006	DOOR	2
007	BASEBOARD	1

PIEZA	DESCRIPCIÓN	CANTIDAD
002	LATERAL	2
003	ESTANTE	6
004	REVÉS MAYOR	4
005	REVÉS MENOR	2
006	PUERTA	2
007	RODOPIE	1

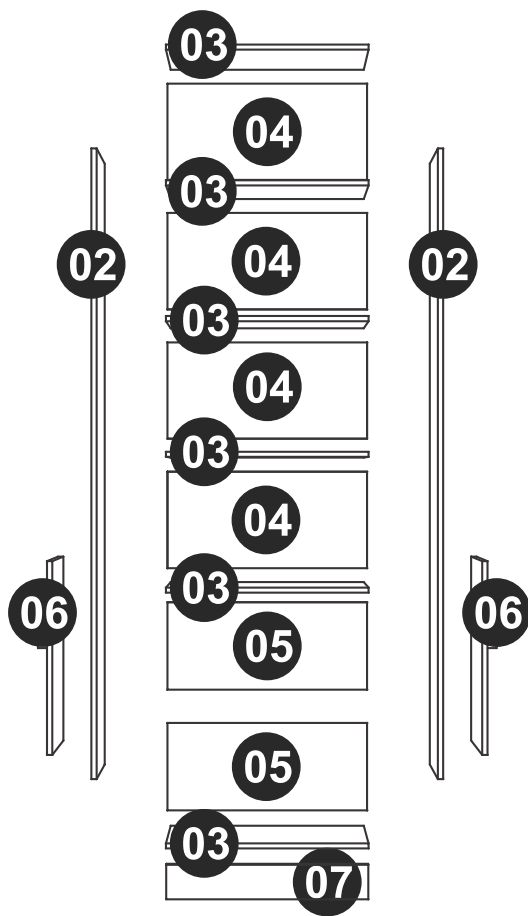



TAPA FUROS x 24
STICKER x 24
TAPAS PLÁSTICAS x 24



PÉS REDONDOS x 4
ROUND FEET x 4
PIES REDONDOS x 4



EF 000266 X 24



EF 000033 x 24
8X30

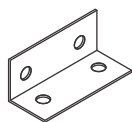

EF 000061 X 02



EF 000132 x 24
4X50 CC



EF 000168 X 94
10X10 C/C



GIZ x 01
CHALK x 01
TIZA x 01

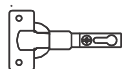

EF 000043 X 4



EF 000027 X 4



EF 000106 x 24
3,5X14 CC



EF 000113 x 04
3,5X30 CF



EF 000246 X 1
5X50 CF



EF 000016 X 1

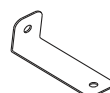

EF 000529 X 1



EF 000248 x 1
3,5X14 CP

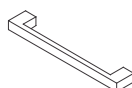

PUXADOR x 2
HANDLE x 2
MANIJA x 2



PERFIL PLÁSTICO x 1
PLASTIC PROFILE x 1
PERFIL PLASTICO x 1

Utilize para medir as ferragens.

Utilice para medir el herraje.

Use for measuring the hardware.

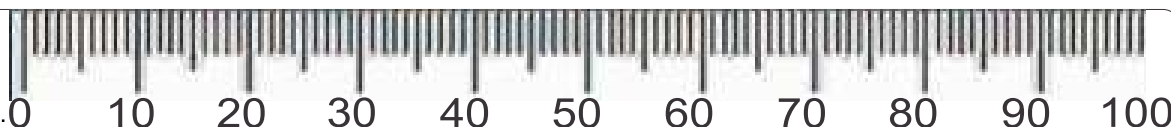

Garantia (exclusivo para o Brasil/exclusivo de Brasil/exclusive to Brazil):

A garantia dos produtos fabricados pela BRV Móveis, abrange eventuais defeitos-vícios de fabricação, no prazo estabelecido pelo código de Defesa do Consumidor, em seu artigo 26.II. o qual prevê a garantia de 90 (noventa) dias.

A = 12 KG - 26.5LB

B = 9KG - 19.8LB

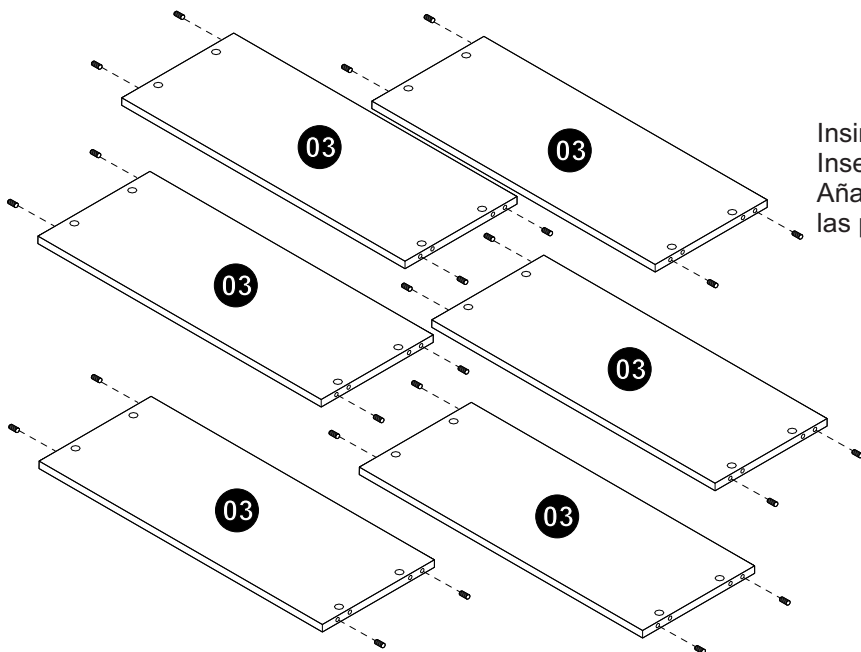
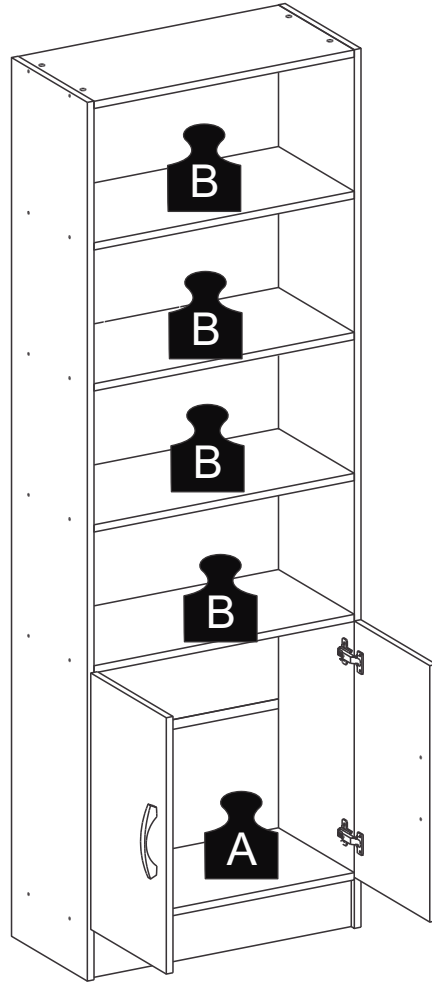

PASSO 1 / STEP 1 / PASO 1

Insira a ferragem EF 000033 nas pré-furações das peças 03.
Insert hardware EF 000033 at pre-drilled holes in pieces 03.
Añade el herraje EF 000033 en los huecos ya marcados en las piezas 03.

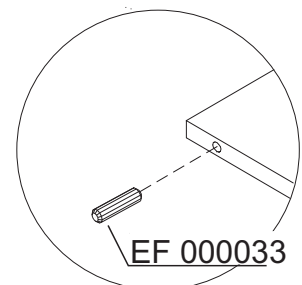

PASSO 2 / STEP 2 / PASO 2

Fixe a ferragem EF 000027 na peça 02, usando a ferragem EF 000106.
Fix hardware EF 000027 at piece 02 using hardware EF 000106.
Fije el herraje EF 000027 en la pieza 02 utilizando el herraje EF 000106.

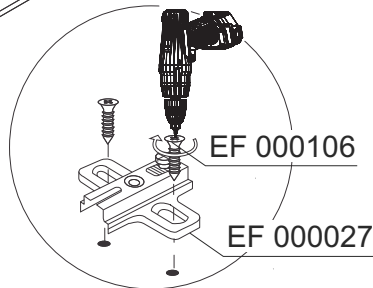
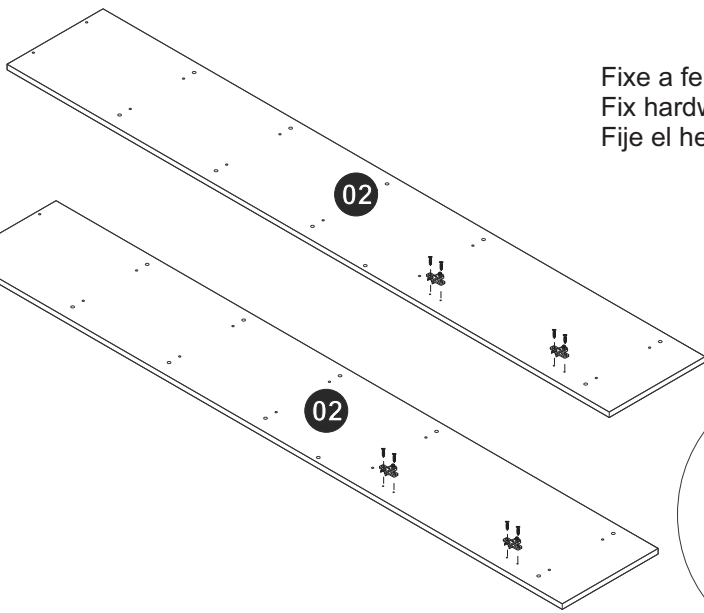

PASSO 3 / STEP 3 / PASO 3

Fixe o puxador nas peças 06 usando a ferragem EF 000113.
Fixe a ferragem EF 000043 usando a ferragem EF 000106.
Fix the handle in pieces 06 using hardware EF 000113. Fix hardware EF 000043 using hardware EF 000106.
Fije la manija en las piezas 06 utilizando el herraje EF 000113.
Fije el herraje EF 000043 utilizando el herraje EF 000106.

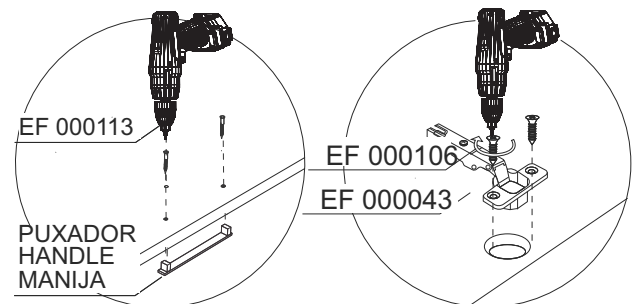
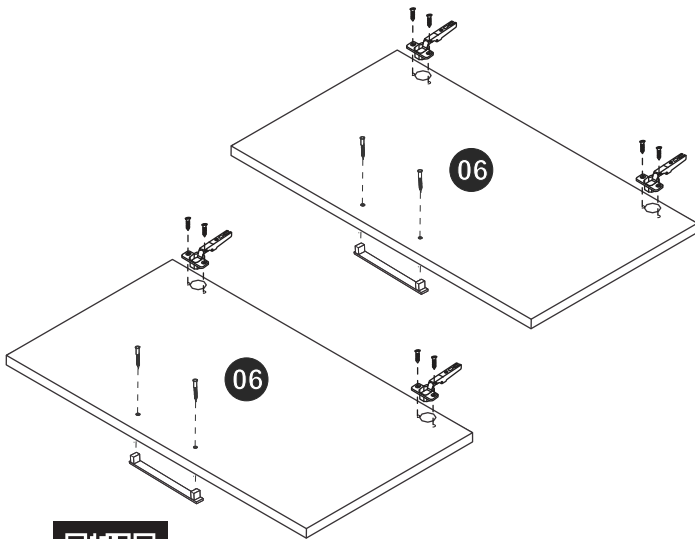

PASSO 4 / STEP 4 / PASO 4

Insira a ferragem EF 000266 nas pré-furações existentes nas peças 03. Utilize a ferragem EF 000132 para unir as peças 02 e 03.
Insert hardware EF 000266 at pre-drilled holes in pieces 03. Use hardware EF 000132 to connect pieces 02 and 03.
Añade el herraje EF 000266 en los huecos ya marcados en las piezas 03. Utilice el herraje EF 000132 para fijar las piezas 02 y 03.

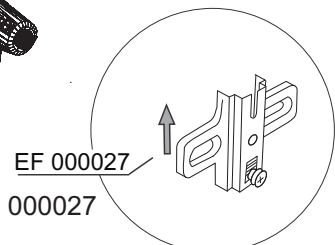
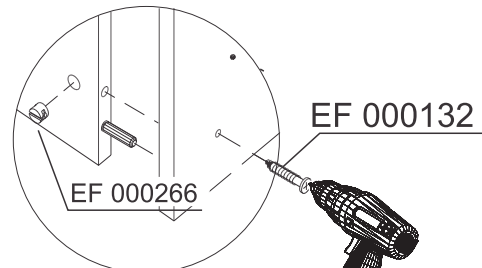
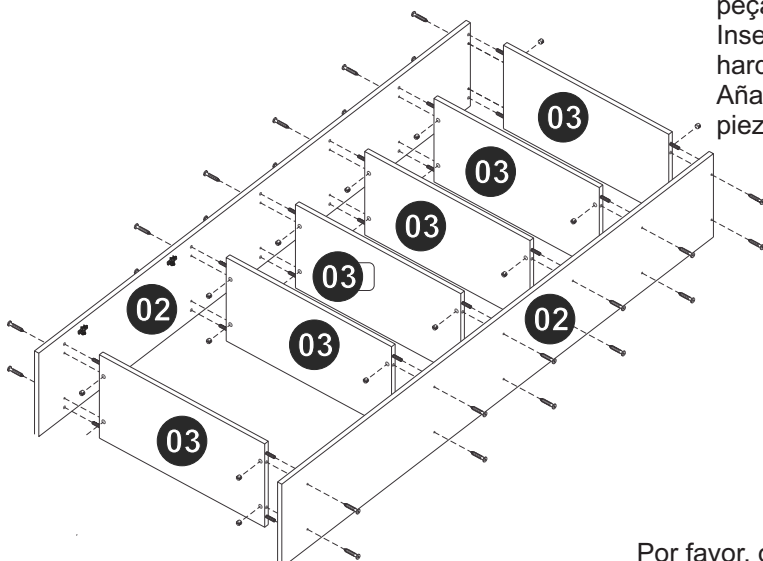

Por favor, observe a posição da ferragem EF 000027
Please, note hardware EF 000027 position.
Por favor, observe la posición del herraje EF000027.

PASSO 5 / STEP 5 / PASO 5

Para fixar a peça 07, utilize as ferragens EF 000061 e EF 000106.
Fixe os pés redondos usando a ferragem EF 000168.

To fix piece 07, use hardware EF 000061 and EF 000106. Fix the round feet using hardware EF 000168.

Para fijar la pieza 07, utilice los herrajes EF 000061 y EF 000106. Fije los pies redondos utilizando el herraje EF 000168.

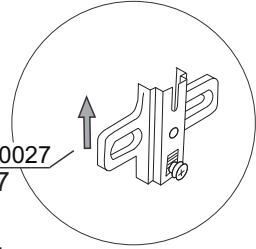
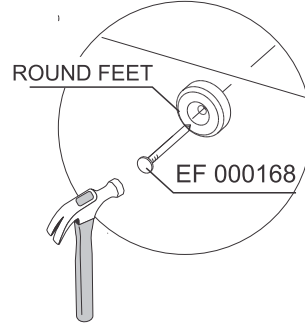
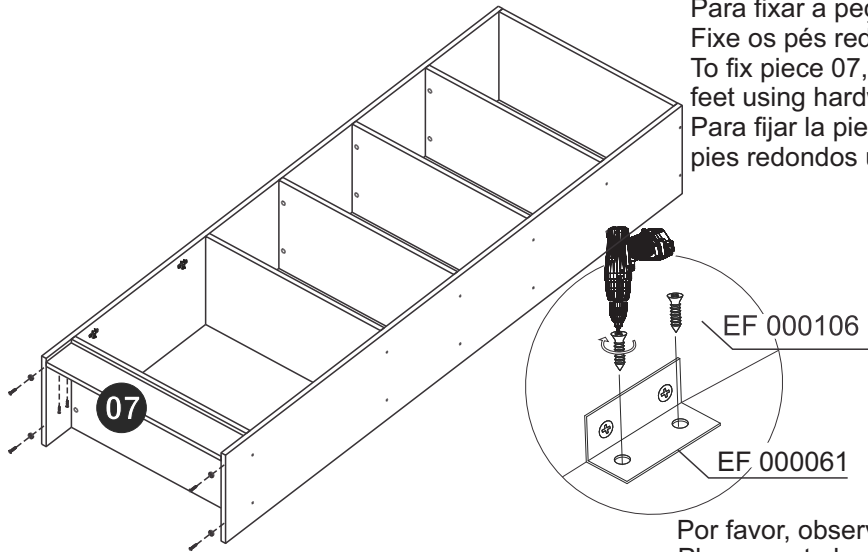

Por favor, observe a posição da ferragem EF 000027
Please, note hardware EF 000027 position.
Por favor, observe la posición del herraje EF000027.

PASSO 6 / STEP 6 / PASO 6

Fixe as peças 04 ao móvel utilizando a ferragem EF 000168.

Use o perfil plástico para unir as peças 05, use a ferragem EF 000168 para fixá-las ao móvel.

Fix pieces 04 to the furniture using hardware EF 000168.

Use the plastic profile to join pieces 05, use hardware EF 000168 to fix them to the furniture.

Fije las piezas 04 al mueble utilizando el herraje EF 000168. Utilice el perfil plástico para unir las piezas 05, utilice el herraje EF 000168 para fijarlas al mueble.

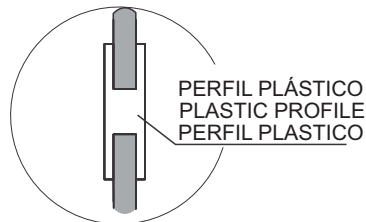
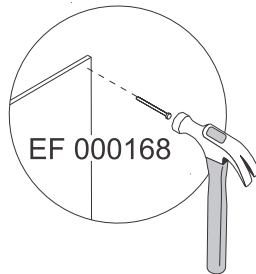
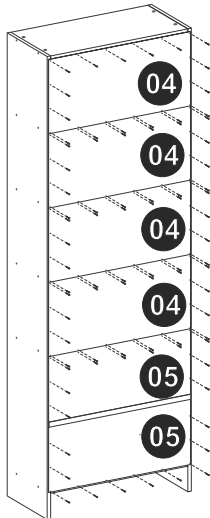

PASSO 7 / STEP 7 / PASO 7

Fixe as peças 06 ao móvel montado.

Fix pieces 06 at the assembled furniture.

Fije las piezas 06 al mueble armado.

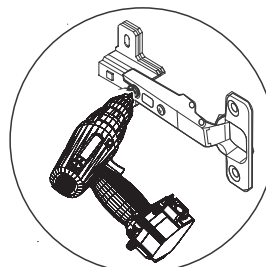
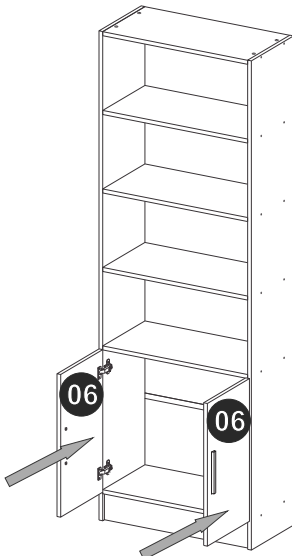

PASSO 8 / STEP 8 / PASO 8

Use o parafuso EF 000248 para fixar a ferragem EF 000529 ao móvel.

Use hardware EF 000248 to fix the hardware EF 000529 at the furniture.

Utilice el herraje EF 000248 para fijar el herraje EF000529 al mueble.

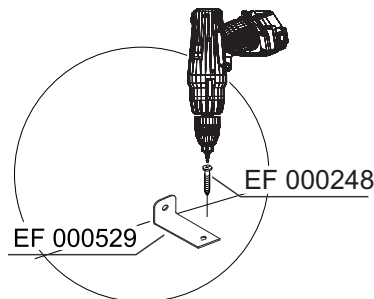
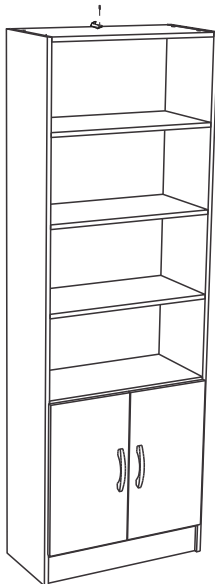

PASSO 9 / STEP 9 / PASO 9

Use as ferragens EF 000246 e EF 000016 para fixar o móvel na parede.

Use hardware EF 000246 and EF 000016 for fixing the furniture on the wall.

Utilice los herrajes EF000246 y EF000016 para fijar el mueble en la pared.

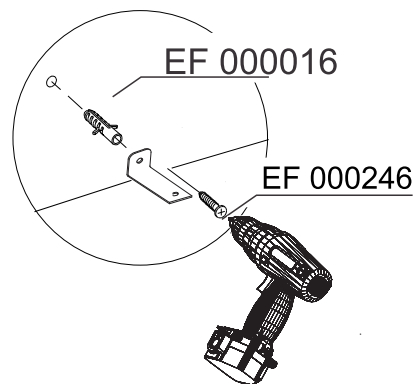
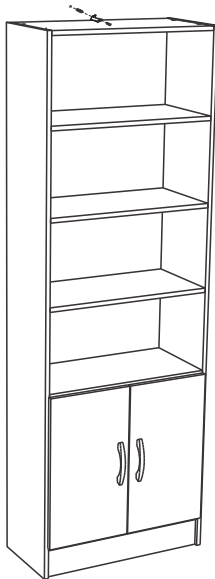

PASSO 10 / STEP 10 / PASO 10

Use o giz para dar o acabamento final ao produto.

Use os tapa furos para cobrir os parafusos aparentes.

Use the chalk to give the final finish on the product.

Use stickers to cover apparent screws.

Utilice la tiza para dar el acabado final al producto.

Utilice los tapa huecos para cubrir los tornillos aparentes.

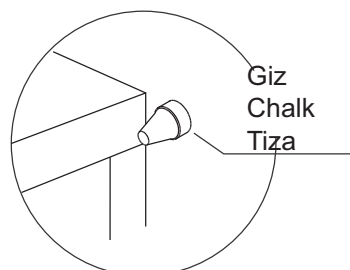
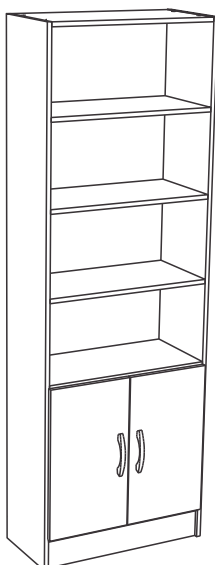

Giz
Chalk
Tiza

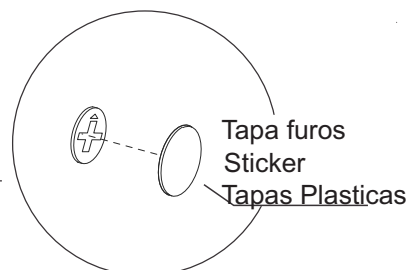

Tapa furos
Sticker
Tapas Plasticas

