

**MONTAGEM
MONTAJE
ASSEMBLING**

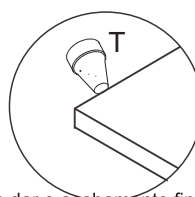

Utilize o giz para dar o acabamento final ao produto.
Utilice la tiza para dar el acabado final al producto.
Use the chalk to give the final finish on the product.

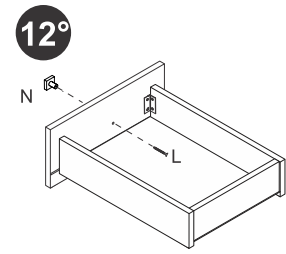
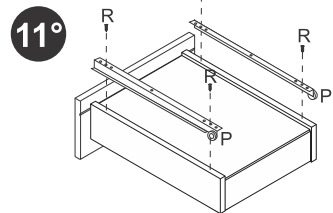
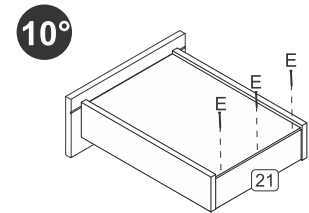
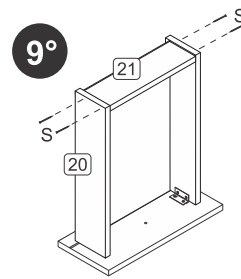
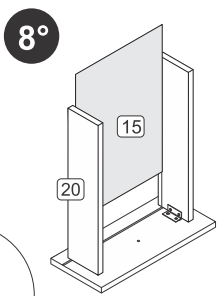
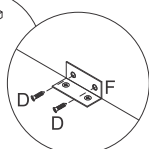
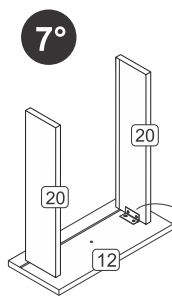
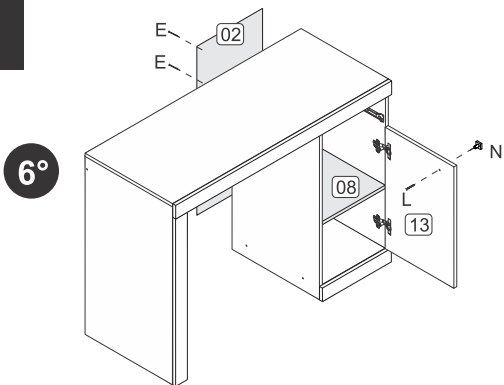

BC35



Ferramentas necessárias
(não fornecidas)
Herramientas necesarias
(no se incluye con el producto)
Needed tools
(not included)

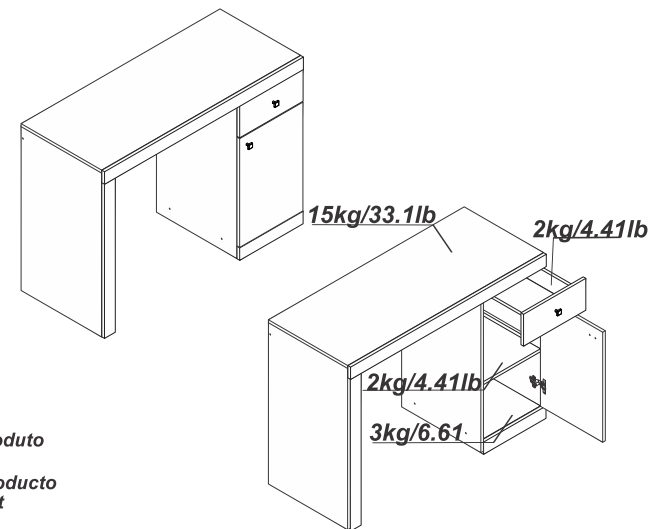

Peso Máximo suportado pelo produto
Peso Máximo suportado por el producto
Product weight limit

Atenção!

1. Parabéns, você está adquirindo um produto com a qualidade BRV Móveis.
2. Antes de iniciar a montagem leia e observe severamente este manual.
3. **IMPORTANTE!** Para que o produto não perca a garantia, solicitamos observar atentamente as orientações de montagem como: fixação do produto na parede, colocação de cola em locais específicos necessários, o peso suportado pelo produto, etc...
4. Caso não sinta segurança em realizar a montagem deste produtor, contrate um profissional capacitado.
5. Aconselhamos utilizar embalagem para forrar o chão, afim de não danificar o produto.

Limpeza:

1. Pano levemente umedecido com água, seguido de pano seco.
2. Não utilizar produtos químicos ou abrasivos.
3. Utilizar pano com álcool **SOMENTE** para eliminar a numeração de identificação da peça.

Atención!

1. Felicitaciones, usted está recibiendo un producto de calidad BRV Muebles.
2. Antes de comenzar el montaje, le a estas instrucciones cuidadosamente.
3. **IMPORTANTE!** Para que el producto no perda la garantía, pedimos que le atentamente las instrucciones, principalmente la fijación del producto em uma pared, colocación de cola em local específico y necesario, el peso suportado por el producto etc...
4. Si usted no se siente seguro em hacer el montaje deste produto, póngase em contacto com um profissional.

Limpeza:

















1. Solamente usar um paño húmedo y jabón neutro.
2. No utilice produtos químicos ou abrasivos.
3. Utilice un paño con alcohol **SOLAMENTE** para sacar los números de identificación de las piezas.

Attention!

1. Congratulations, you're acquiring a product with BRV Móveis quality.
2. Before starting to assemble the product, read and observe carefully this manual.
3. **IMPORTANT!** In order to keep the guarantee of the product we request to carefully observe the guidances like: fixing the product on the wall, adding glue in needed and specified places, product weight limit, etc.
4. In case you don't feel confident to assemble this product, contact a professional to do the job.
5. We advise to use the package to protect the floor in order to prevent damages.

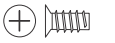
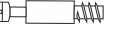
Cleaning:

1. Slightly dampened cloth and after a dry cloth.
2. Do not use chemicals or abrasives.
3. Alcohol can be used **ONLY** to delete the identification numbers of the pieces.

Ferragens/Herrajes/Ironmongery (mm)	QTD.	Ferragens/Herrajes/Ironmongery (mm)	QTD.
A  8x30	08	J 	06
B  3,5x40	06	K 	02
C 	06	L  3,5 x 30	02
D  3,5x14	44	M 	04
E  10x10	25	N 	01
F 	09	P 	01
G 	06	Q  6,0x10	04
H 	06	R  3,5x14	04
		S  13x15	04
		T 	01

COD	Descrição/Descripción/Description	QTD.	mm	in
1-3838	Base/Base/Base	01	320x445x15	12.6x17.5x0.59
2-0000	Costa/Revés/Back	01	745x335x2,5	29.3x13.2x0.09
3-3847	Divisória/Divisorio/Partition	01	790x445x15	31.1x17.5x0.59
4-3849	Lateral direita/Lateral derecha/ Right side	01	790x445x15	31.1x17.5x0.59
5-3848	Lateral esquerda/Lateral izquierda/Left side	01	790x445x15	31.1x17.5x0.59
7-3598	Vista Maior/Detalle Mayor/Longer Detail	01	1100x60x15	43.3x2.36x0.59
8-3831	Prateleira Móvel/Estante Móvil/Mobile Shelf	01	320x445x15	12.6x17.5x0.59
9-3850	Tampo/Tapa/Top	01	1100x445x15	43.3x17.5x0.59
10-3828	Vista Lateral/Detalle Lateral/Detail Side	01	745x60x15	29.3x2.36x0.59
11-3843	Travessa/Travessa/Detail	01	119x733x15	4.69x28.9x0.59
12-3845	Frente de gaveta/Frente cajón/Front drawer	01	155x350x15	6.10x13.8x0.59
13-3846	Porta/Puerta/Door	01	521x350x15	20.5x13.8x0.59
14-3834	Vista Menor/Detalle Pequeño/Lower Detail	01	60x351x15	2.36x13.8x0.59
15-0000	Fundo de gaveta/Fondo cajón/Drawer base	01	405x275x2,5	15.9x10.8x0.09
20-0000	Lateral de gaveta/Lateral cajón/Side drawer	01	400x93x15	15.7x3.66x0.59
	Revés cajón/Back of drawer	01	265x80x15	10.4x3.15x0.59

**PRÉ-MONTAGEM
FASE DE PREPARACIÓN
DE LAS PIEZAS**

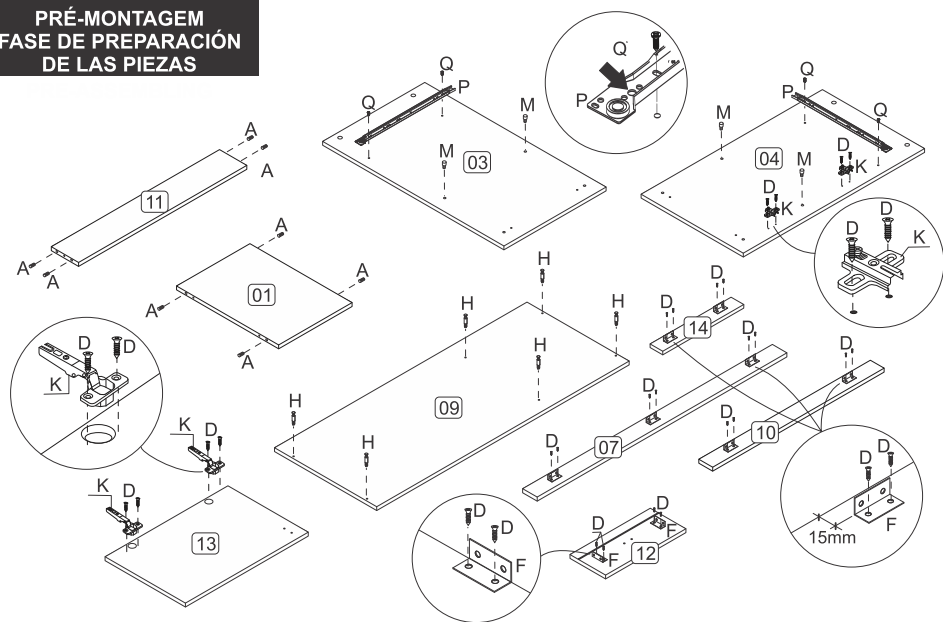

**MONTAGEM
MONTAJE
ASSEMBLING**

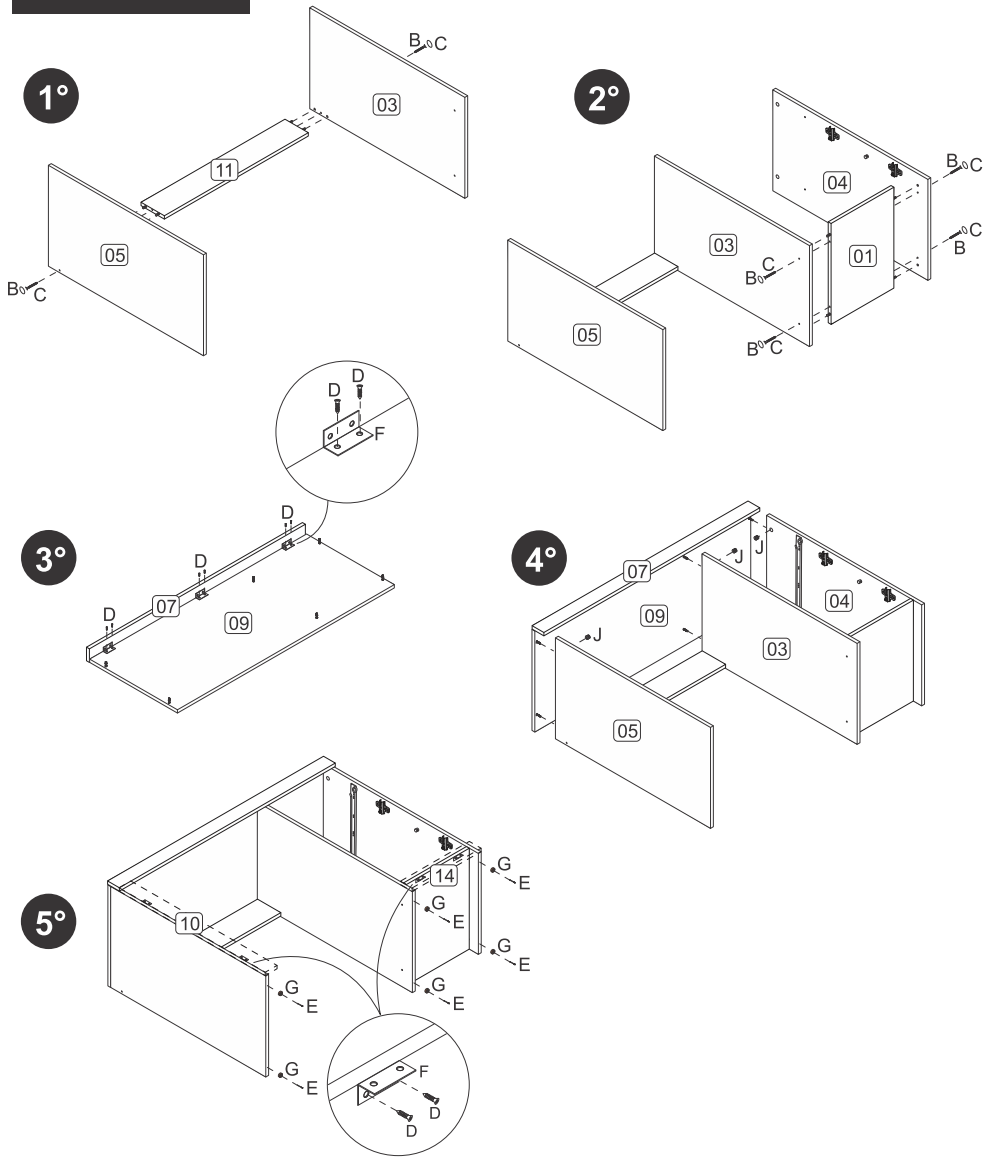

Garantia (exclusivo para o Brasil/exclusivo de Brasil/exclusive to Brazil):
A garantia dos produtos fabricados pela BRV Móveis, abrange eventuais defeitos-
vícios de fabricação, no prazo estabelecido pelo Código de Defesa do Consumidor,
em seu artigo 26,II, o qual prevê a garantia legal de 90 (noventa) dias.

